

emco



**Universal CNC turning
center with milling
drive and Y-axis**



MAXXTURN 65 G2

COMPLEX TASKS SOLVED QUICKLY AND PRECISELY.

The new MAXXTURN 65 G2 has undergone an extensive redesign and, in addition to two powerful motor spindles, now also offers an optional BMT turret with direct drive. For the first time, three spindle sizes can be offered. A steady rest is available for shaft machining if required. While the proven two-part basic design has been retained, the integration of the chip conveyor has been optimized.



Distributor body
(Stainless steel)

1 WORK AREA

- / Easily accessible workspace
- / Optimal chip flow
- / Guideways fully covered

2 MAIN SPINDLE

- / Water-cooled motor spindle
- / High drive performance
- / Thermoresistant construction
- / Large speed range
- / A2-6 (A2-8) spindle connection
- / Bar capacity Ø 65 (76,2/95) mm

3 TOOL TURRET

- / 12-station VDI 30 radial turret with 12 driven tool positions
- / VDI 40 radial turret available as an option
- / 12- or 16-station BMT turret with water-cooled direct drive available as an option
- / Swivel speed adjustable with override
- / Tapping without length compensation
- / Polygon turning, gear cutting operations, etc.

4 MACHINE COVER

- / All-round protection from chips
- / 100% coolant retention
- / Large safety glass window in door
- / Clear view of the work area
- / Built-in buttons for operator convenience

5 CHIP CONVEYOR (option)

- / Hinged type conveyor belt version
- / Ejection height 1110 mm
- / Level indicator and level monitoring
- / Emergency stop and maintenance switch
- / Coolant volume 250 litres

6 OIL SEPARATOR (option)

- / Mechanical separator
- / Pressure gauge for contamination display
- / HEPA after-filter attachment, filter class H13
- / Max. suction capacity: 1040 m³/h

7 FINISHED PARTS BELT (option)

- / Gentle parts deposit
- / Usable storage area 350 x 870 mm
- / Programmable by means of M-function
- / Chip button and coolant recirculation

8 CONTROL

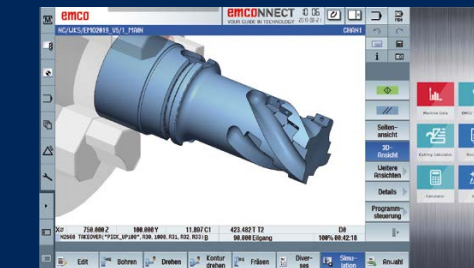

SINUMERIK ONE with OPERATE

- / Dialog programming SHOPTURN/SHOPMILL
- / 3D simulation for process verification
- / 22" MULTI-TOUCH screen
- / Ergonomically arranged
- / Height adjustable and tiltable
- / EMCONNECT process assistant as a basis for the SMART FACTORY (optional)



Machine with optional equipment

CONSTRUCTION

1 MAIN SPINDLE

- / Dynamic direct drive
- / High drive power
- / Compact, thermostable construction
- / Large speed range
- / A2-6 (A2-8) spindle connection
- / Bar capacity diameter \varnothing 65 mm (76,2/95)

2 MACHINE BASE

- / Extremely stiff welded steel construction
- / Compact structure
- / Very high thermostability
- / Filled with vibration-absorbing material

3 ROLLER GUIDES

- / In all linear axes
- / Preloaded
- / No backlash in any direction of force
- / High rapid motion speed
- / No wear
- / Minimal lubrication

4 TOOL TURRET

- / VDI quick change system
- / 12 driven tool stations
- / No alignment of the tool holder
- / Can be used on both spindles
- / 12- or 16-station BMT turret with direct drive (max. 12000 rpm) available as an option

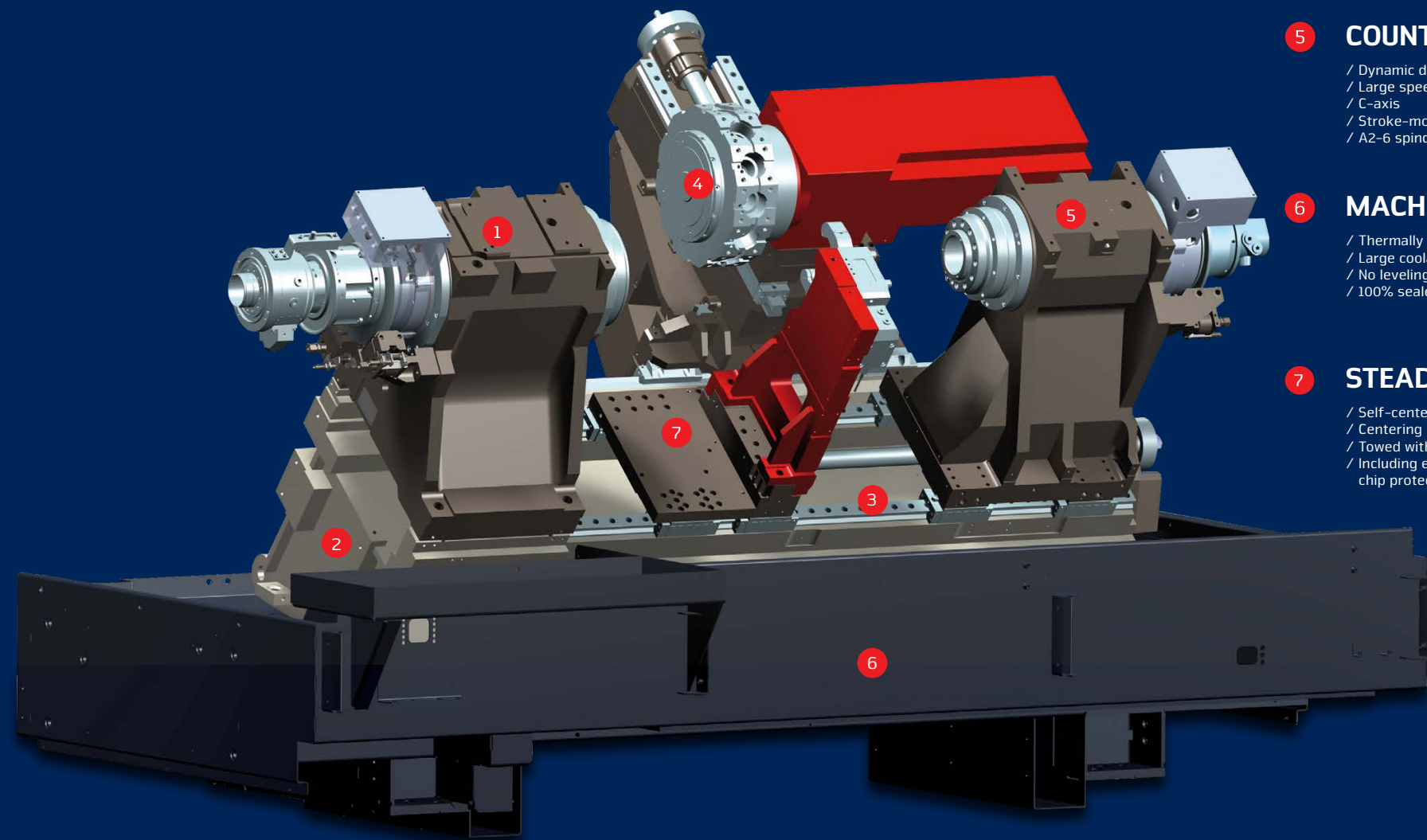

5 COUNTER SPINDLE

- / Dynamic direct drive
- / Large speed range
- / C-axis
- / Stroke-monitored parts ejector
- / A2-6 spindle connection

6 MACHINE STAND

- / Thermally isolated from the machine base
- / Large coolant container that is easy to clean
- / No leveling necessary
- / 100% sealed against coolant leaks

7 STEADY REST SLIDES

- / Self-centering steady rest
- / Centering range: \varnothing 8-101 mm
- / Towed with Z-slide
- / Including end position control, chip protection and sealing air

PERFORMANCE AND TORQUE

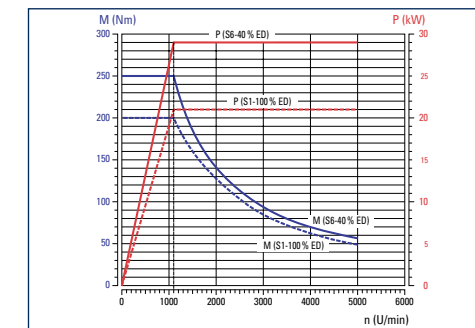

Main spindle \varnothing 65/76,2 mm

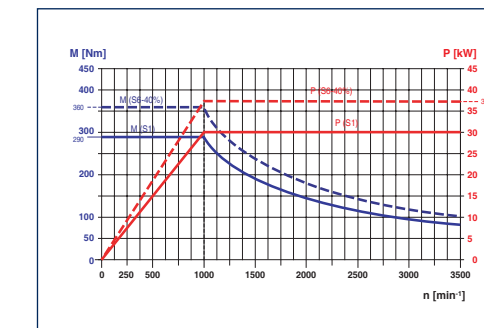

Main spindle \varnothing 95 mm

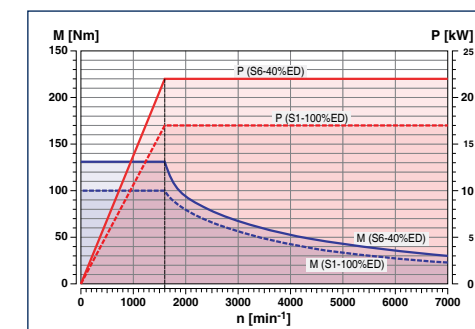

Counter spindle \varnothing 45 mm

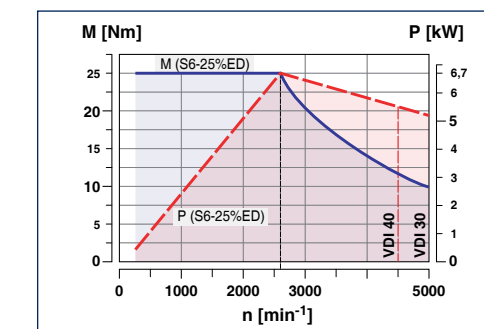

Tool turret - VDI 30/40 driven tools

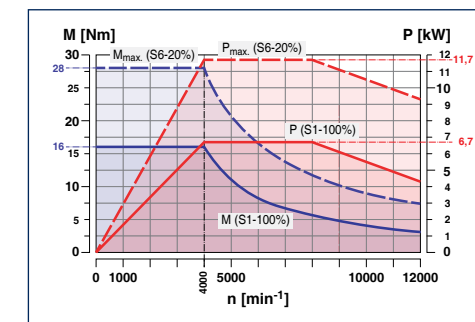

Tool turret with direct drive - BMT55P

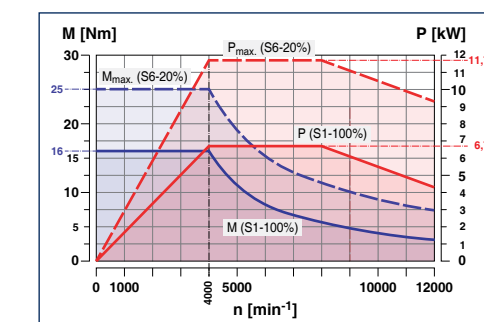

Tool turret with direct drive - BMT45P

TECHNICAL HIGHLIGHTS

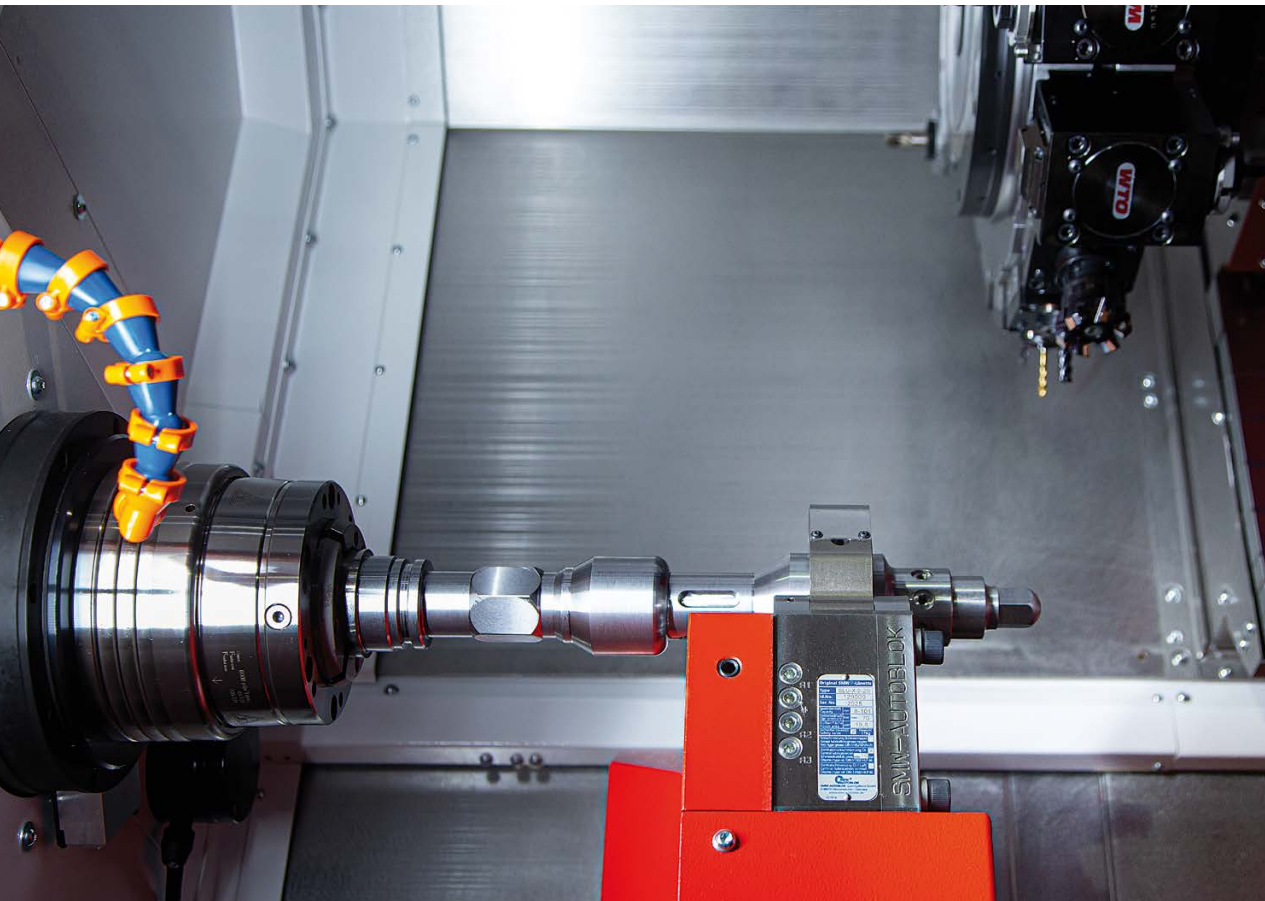

WORK AREA

The generously dimensioned work area provides space for a large number of tools on the tool turret and, with an angle of inclination of 40°, ensures continuous chip flow even during low-manpower operations. An optional drag steady rest enables precise and safe machining of long shaft components. When not in use, it can be removed quickly and easily. The work area is optimally accessible, which also facilitates the setup for small batch sizes.

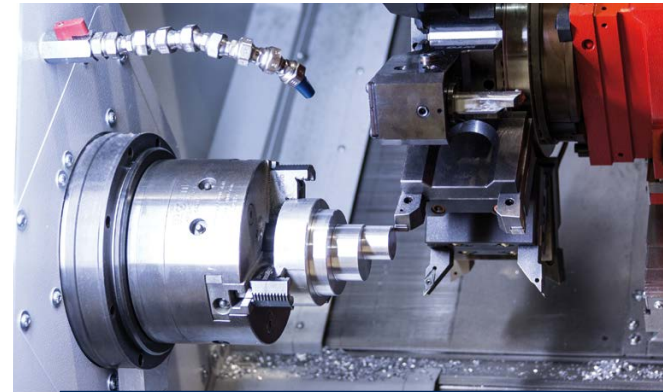

MAIN SPINDLE

There are three spindle sizes to choose from. One is the 65 spindle with A2-6 and for larger bar parts once the 76 and the 95 spindle with A2-8. For complex milling operations, the spindle can be moved interpolating. The direct drive ensures extremely precise and dynamic positioning.

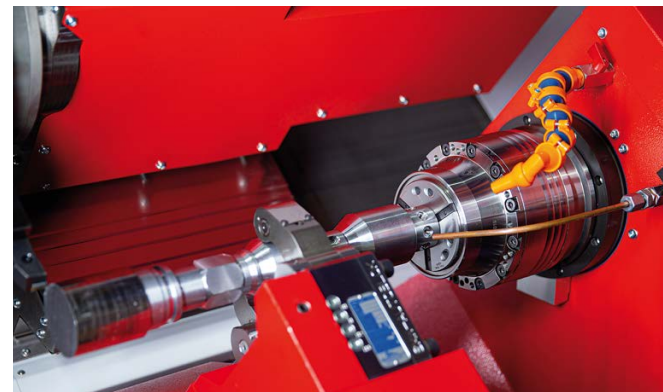

COUNTER SPINDLE

The counter spindle is available for complete workpiece machining. Turning, milling and drilling operations can thus also be performed on the back of the workpieces. The concentric takeover of the workpieces offers another advantage: the possibility to maintain a very high level of accuracy with regard to the coaxiality, concentricity and angular position values.

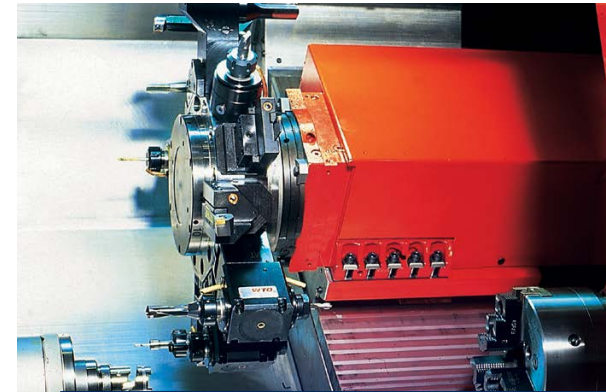

TOOL TURRET WITH VDI QUICK-CHANGE SYSTEM

Fast 12-fold servo turret with very short switching times for VDI 30 or VDI 40 tools. The angle holders are equipped with ground alignment plates. This eliminates the need for time-consuming alignment of the tool holders. All stations are driven and the swivel speed is adjustable.

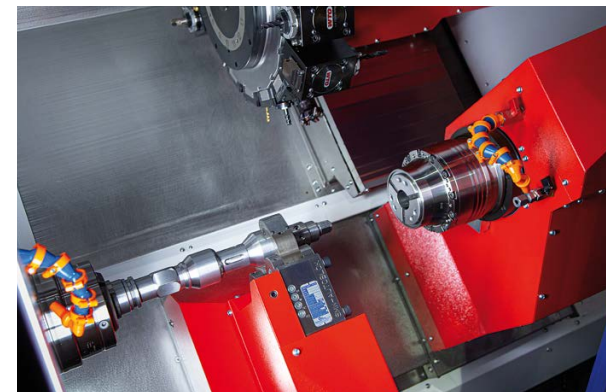

STEADY REST

The hydraulically operated steady rest with a centering range of $\varnothing 8 - 101$ mm sits on a sliding carriage which is dragged and positioned over the tool slide. It is hydraulically clamped into position by a clamping device. Equipped with chip protection and end position control, the steady rest is connected to the central lubrication system.

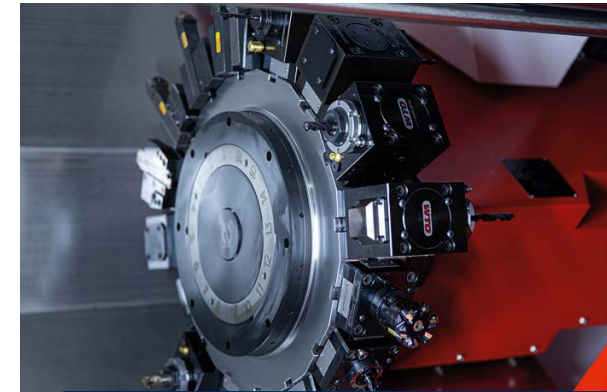

BMT TURRET WITH DIRECT DRIVE

For the economical production of complex turning/milling workpieces with a predominantly milling component, a 12- or 16-position BMT turret with direct drive is available as an option. With up to 12000 rpm, this turret offers optimum conditions for complete machining. The stable BMT interface allows coolant pressures of up to 50 bar as standard and up to 150 bar as an option. Further advantages are the changeover accuracy and stability of the interface.

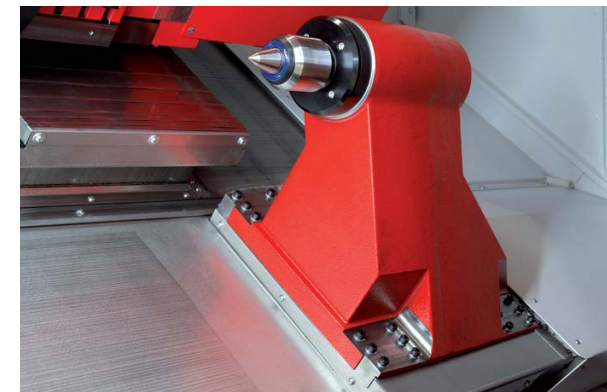

TAILSTOCK

In order to support slim components, the MAXXTURN 65 G2 includes a fully automatic tailstock. It is hydraulically moved over a length of 500 mm. The centre with MT4 cone is directly included in the tailstock body. This ensures compactness and highest stability.

HIGHLIGHTS

- / Powerful driven tools
- / Y-axis for complex milling operations
- / Counter spindle for complete machining
- / Flexible automatic tailstock
- / Steady rest for supporting shafts
- / Very compact machine layout
- / State-of-the-art control technology
Sinumerik ONE incl. Shop Turn
- / Made in the Heart of Europe

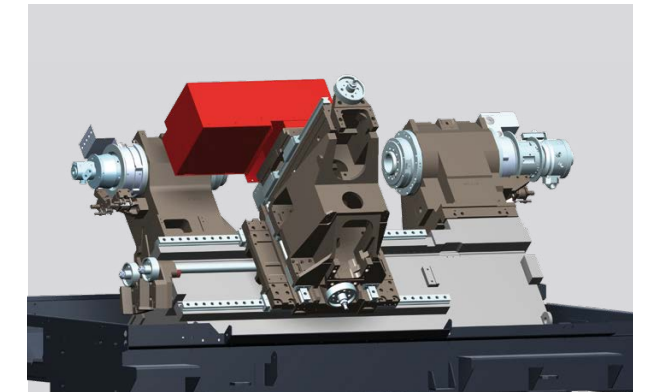

Y-AXIS CARRIAGE

The 90° offset machine base with the broad-based, prestressed guide rails ensures short overhangs and top stability for complete machining.

NETWORKS ARE CREATED INDIVIDUALLY – OUR SOLUTIONS AS WELL

Staying in touch is not only important for people. Staff, machines and the production environment must also be securely networked with each other to ensure an efficient production process. With EMCONNECT, the machine is optimally equipped for this. In addition, EMCONNECT Digital Services provides innovative online services to optimise machine operation. The machine data form the basis for a wide range of applications. In this way, the user has the status of the machine available at any time and in any place.

Integration into the control

EMCONNECT offers options for situation-dependent operation. Apps can also be used in parallel with the control system. With optimal integration into the NC control system, EMCONNECT complements the NC control with powerful functions for modern control generations (SIEMENS, HEIDENHAIN, FANUC). The familiar vision of the machine NC control is maintained at all times.

An innovative concept

These powerful apps may be used independently from the control, while in the background the machine is busy in the production process. With only one click, you can change at any moment between numerical control and EMCONNECT. This is possible with the help of an innovative and ergonomic control panel, equipped with a modern 22" multi-touch display, an industrial PC with associated keyboard and HMI hotkeys.

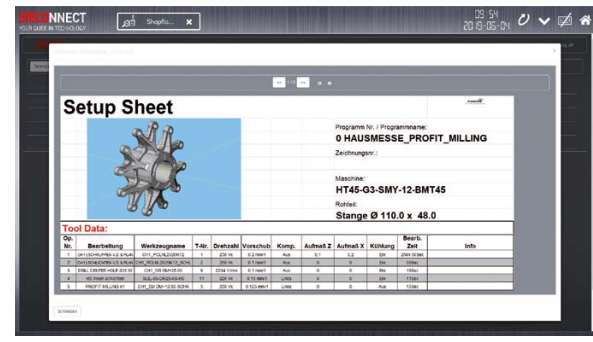

Control panel as central platform

With EMCONNECT, the machine control panel becomes a central platform with access to all necessary applications, data and documents. Remote Support, Web Browser and Remote Desktop offer a wide range of connection options, even outside the direct production environment. The optional OPC UA interface allows data exchange with the IT system environment and interaction with other machines for shop floor automation. In this way, EMCONNECT makes an important contribution to highly efficient machine operation.



Innovative online services

With EMCONNECT Digital Services, all interested users have online access to the current status and evaluations of the machine. Automatic notification in the event of malfunctions or machine stoppages and extended diagnostic options for remote maintenance reduce downtimes and machine downtime to a minimum. Integrated maintenance management supports predictive maintenance based on machine utilisation. Thanks to the continuous development of online services, new functions are always available.

EMCONNECT HIGHLIGHTS AND FUNCTIONS

- / Fully networked**
Remote access to office computers, web browsers and online services with all applications and users connected
- / Structured**
Clear monitoring of the machine state and the production data
- / Customized**
Open platform for modular integration of customer-specific applications
- / Compatible**
Interface for seamless integration into the operating environment
- / User-friendly**
Intuitive and production-optimized touch operation
- / Future-proof**
Continuous extensions as well as easy updates and upgrades

Standard-Apps

Control	Dashboard	Machine Data
System	Maintenance Manager	Digital Services
Remote Desktop	Settings	Web Browser
Remote Support	TeamViewer	Service
Cutting Calculator	Calculator	Notes
Backup & Restore	File Import	Documents
GD&T	EMCO TechSheet	Thread Reference



Optional

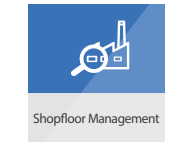

THE EMCO GANTRY LOADER. INDIVIDUAL PROCESS OPTIMIZATION.

- 1 GANTRY LOADER
- 2 PALLET MAGAZINE (20 stations)
- 3 GRIPPER SYSTEM



ADVANTAGES

- / Fully automatic loading and unloading of the workpieces
- / Multi-channel Sinumerik control incl. user cycles
- / Seamless interplay between the machine tool and the loading device
- / Varied possibilities of customer-specific adaptation
- / Possibility of integration of measuring station, signing station, cleaning station, etc.
- / Short spare time due to a loading hatch

AUTOMATIC RETURN ON INVESTMENT

Workpiece magazine

Blank-specific pallet attachments enable oriented loading of blanks into the machine and increase the parts stock for unmanned production. Changeover times are reduced or eliminated thanks to the perfect adjustment to the customer's parts.



4-station pallet attachment for tees

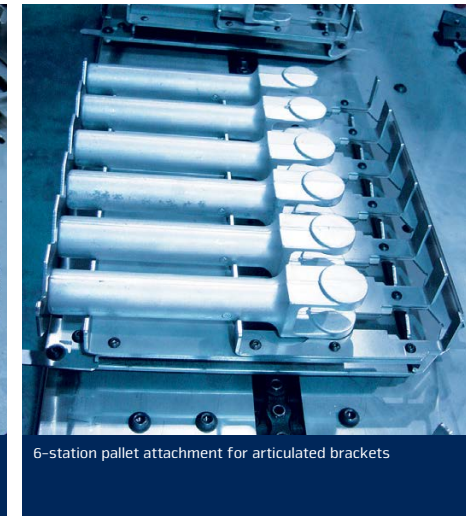

6-station pallet attachment for articulated brackets



Multi-pallet attachment for a family of parts

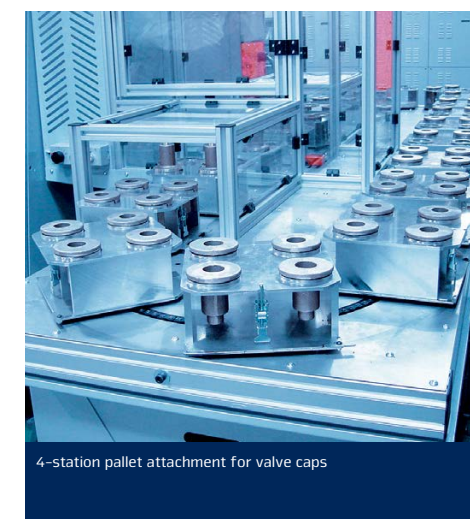

4-station pallet attachment for valve caps



20-station pallet magazine with customer-specific pallets

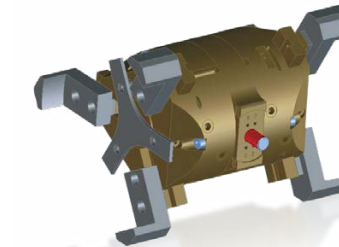

2 x 3-jaw double gripper head

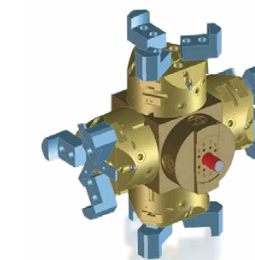

4 x 3-jaw gripper head



Shaft gripper head

Turn-/Mill-Assist by EMCO

Compact standard automation for small and medium-sized batches for turning and milling machines.

More compact and more user-friendly than comparable solutions - characteristics that best describe the Turn/Mill-Assist for loading and unloading EMCO turning or milling machines. Depending on your range of parts and batch sizes, you can choose from among several models.

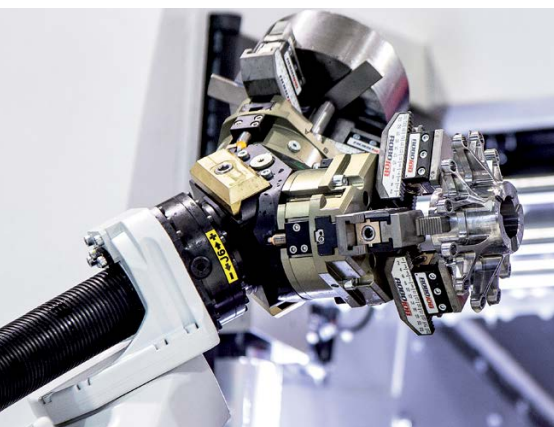

Compact, flexible all-in-one solution: MAXXTURN 65 G2 with Turn-Assist

/ Koren Peter
Product Sales Manager Automation

„The Turn-/Mill-Assist by EMCO is an automation concept tailored to the machining industry's requirements. I think that very short setup times and user-friendliness are decisive factors when it comes to profitable production.“



1 OPTIMISED PROCESSES

With Turn-/Mill-Assist by EMCO, you will increase your profits and reduce the working hours by up to 70%.

- / Compact and space-saving solution
- / Graphically supported operation
- / Free access to the machine door
- / For small and medium-sized series
- / Very short configuration and setup times
- / No special knowledge about robots required
- / On-site installation and training

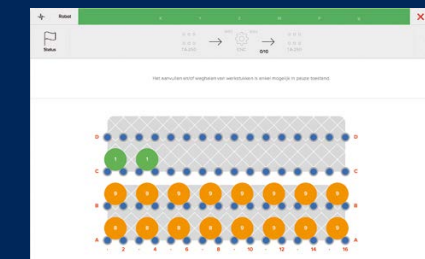

2 INTUITIVE, GRAPHICALLY SUPPORTED OPERATION COMBINED WITH CLEVER MECHANICS

Thanks to the very beginner-friendly control unit, the operator can quickly move into the implementation phase, thus increasing the processes' efficiency, profitability and flexibility to a significant extent.



3 SERVO-CONTROLLED STACKING TABLES

This model is equipped with two servo-controlled stacking tables which are capable of stacking larger quantities of both blanks and machined parts. This too is a contribution to longer unmanned production times during which your skilled workers can be entrusted with other activities.

✓ The EMCO short bar loaders.
Universal and powerful.



SHORT AND TO THE POINT.

The EMCO SL 1200 is the perfect solution for automatic feeding and loading of cut-to-length bars. The key advantages are a small footprint and rapid loading times resulting from shorter strokes.

The technology. The EMCO SL 1200 can be used immediately as a "plug-and-play" solution. Their extremely small footprint enables processes to be automated even if space is tight. Apart from complying with the latest safety requirements, it is easy to operate and

moveable for service purposes. Besides, it can comfortably be incorporated into the production process using the machine control's programme input masks. Minimum setup efforts are required when switching over to other bar diameters.



EMCO SL 1200

Space-saving and cost-effective bar loading magazine. Operation and programming could not be easier. May also be used for loading single items through the lathe's main spindle.



Material storage

The material storage surface with a length of 560 mm is arranged at the rear of the bar loader in a manner with no influence whatsoever on the space available. Depending on the diameter it is possible to store a different number of short bars.

THE BENEFITS

- / Small footprint
- / Easy to use
- / Short feed times
- / Fast, straightforward changeover
- / Option to load individual workpieces
- / Central diameter adjustment
- / The loader operates without oil
- / Ergonomic EMCO design

Technical data	SL 1200
Bar diameter	Ø 8 – 95 mm
Max. bar length	1200 mm
Min. bar length	150 mm
Max. bar weight	45 kg
Material storage length	approx. 560 mm
Feed rate	0 – 60 m/min
Bar change time	approx. 15 sec.
Dimensions (L x W)	1700 x 1250 mm
Weight	approx. 500 kg

OPTIONS

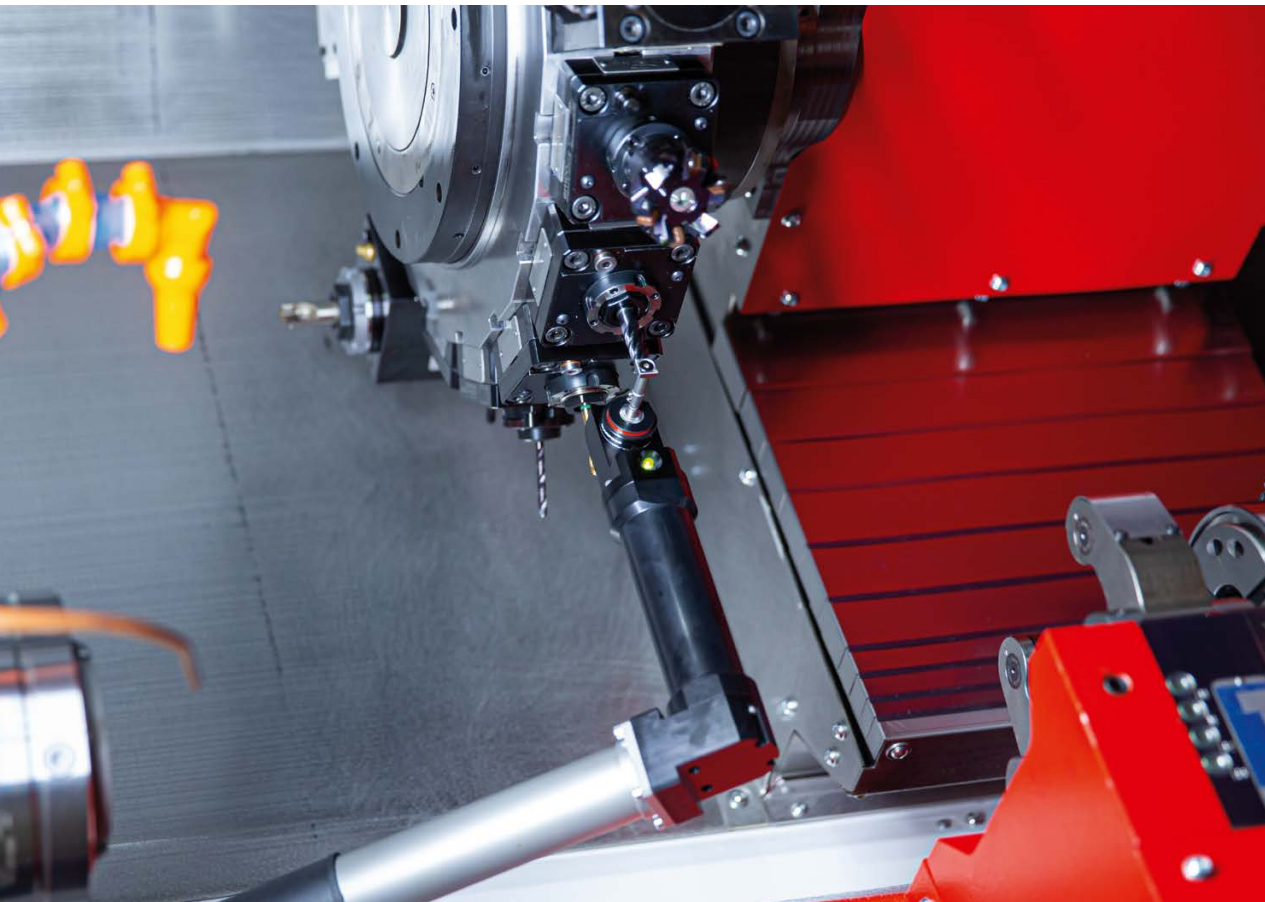

TOOL MEASUREMENT

The optional tool measuring sensor in the work area allows for fast and precise tool measurement within the machine. It is manually mounted below the main spindle. After use, it is removed and placed onto a tray on the left-hand side of the machine casing.

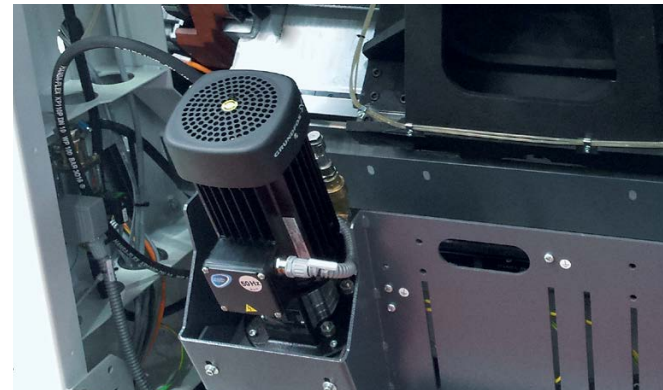

INCREASED COOLANT PRESSURE

A 14 bar coolant pump is available as an option and alternative to the 3.5 bar version. It completes the pumps in the basic machine. For maintenance purposes and to clean the coolant tray, the pumps can easily be swung out so that the coolant tray can be pulled out towards the front.



AUTOMATIC WORKPIECE MEASUREMENT

With a radio measuring probe on the turret, certain features on the workpiece can be measured and precisely reworked while the process is still running. Extensive measuring cycles facilitate the application.



FINISHED PARTS CONTAINER

The parts catcher automatically transports the finished parts to a container. The workpieces can be removed at any time for inspection. A safety flap prevents any risk of injury.



FINISHED PARTS CONVEYOR

The finished parts catcher places the machined parts onto a collector belt. Since the belt is clocked, the parts – which are often very complex – are kept from falling on top of each other.



CHIP CONVEYORS

Instead of the coolant trough in the basic machine, a slat-band chip conveyor can be offered as an option. It reliably conveys chips of various types out of the machine's working area. This enables low-manpower operations.



BELT FILTER SYSTEM

If required, it is possible to install an optional 600-litre belt filter system with 25 bar high-pressure coolant pumps. It increases both the cooling emulsion volume and the coolant's service life.

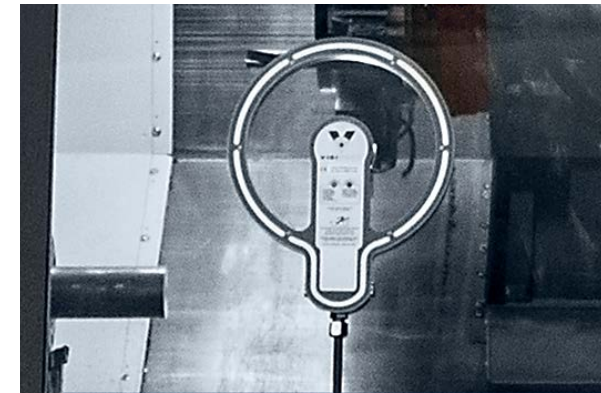

SPIN WINDOW

The optional spin window allows for a perfect view into the work area, also during machining with coolant. Thanks to the spinning pane, the coolant is slung away immediately after the impact. Thus, the pane remains perfectly clear.



TOOL MEASURING ARM STORAGE

Protected storage area for the measuring sensor and the adjustment gauge.

MACHINE LAYOUT

Machine layout MT65 G2

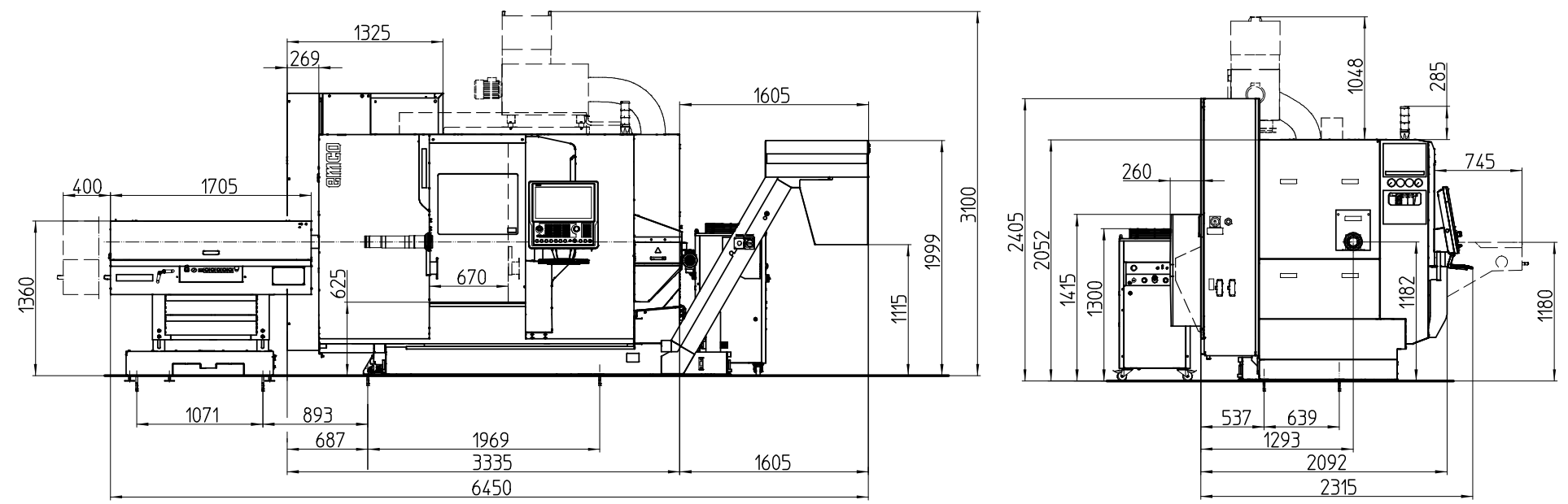

Indications in millimeters

WORK AREA

Work area MT65 G2 with 12-position VDI 30 turret

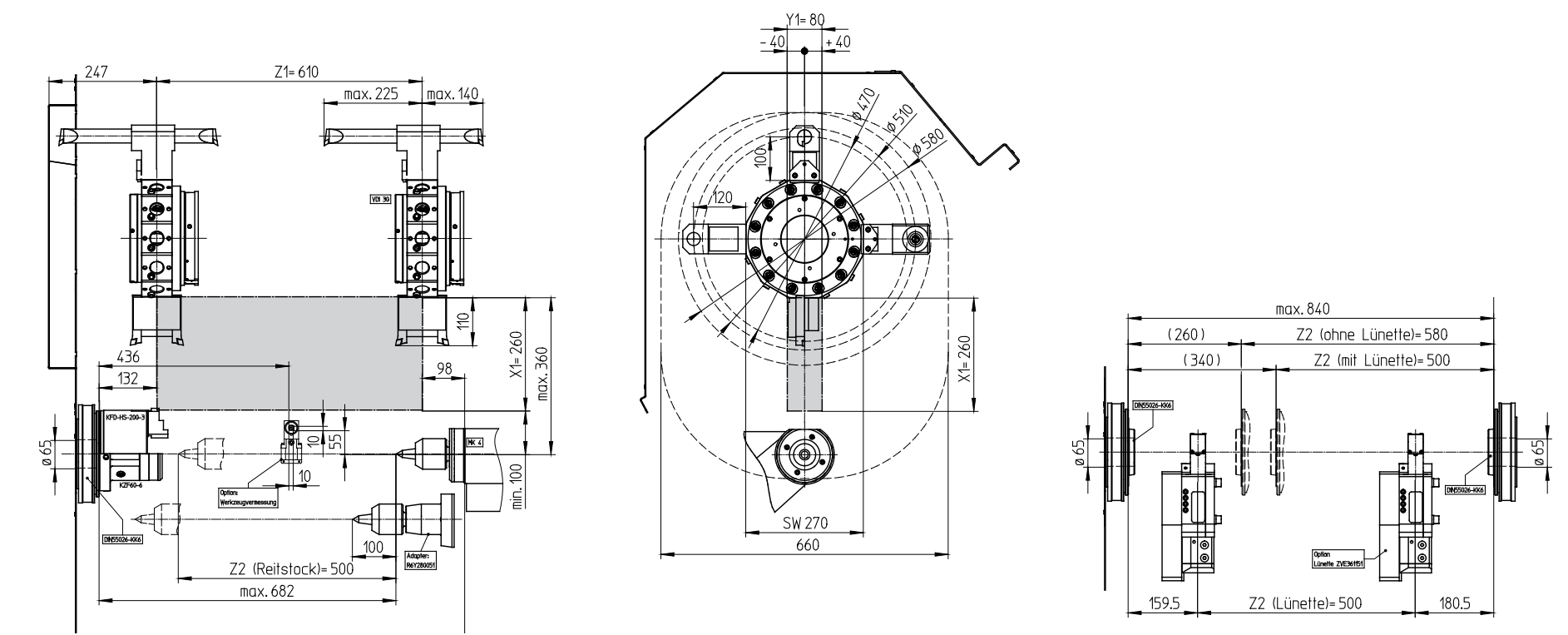

Indications in millimeters

WORK AREA

Work area MT65 G2 with 12-position BMT55 turret

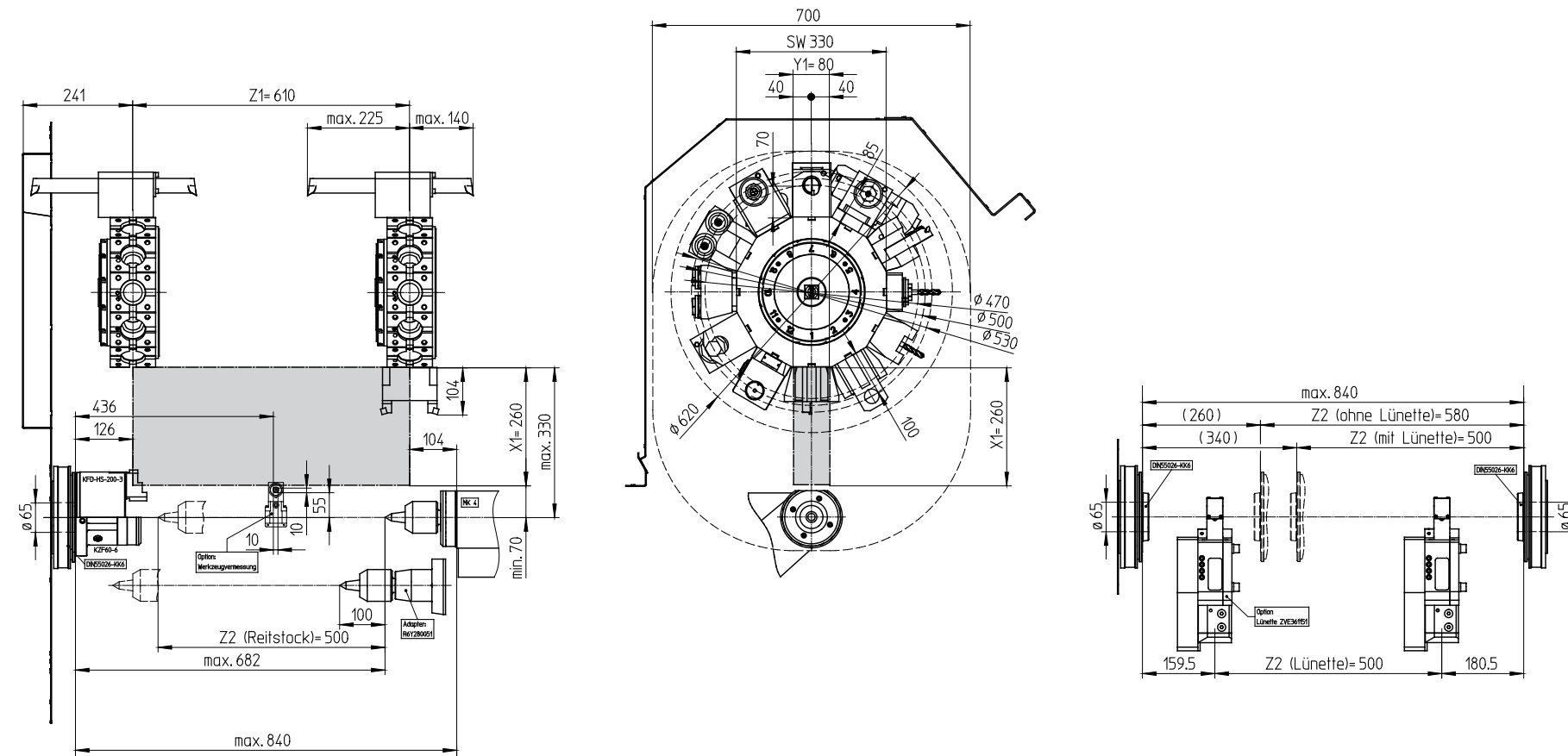

Indications in millimeters

WORK AREA

Work area MT65 G2 with 16-barrel BMT45 turret

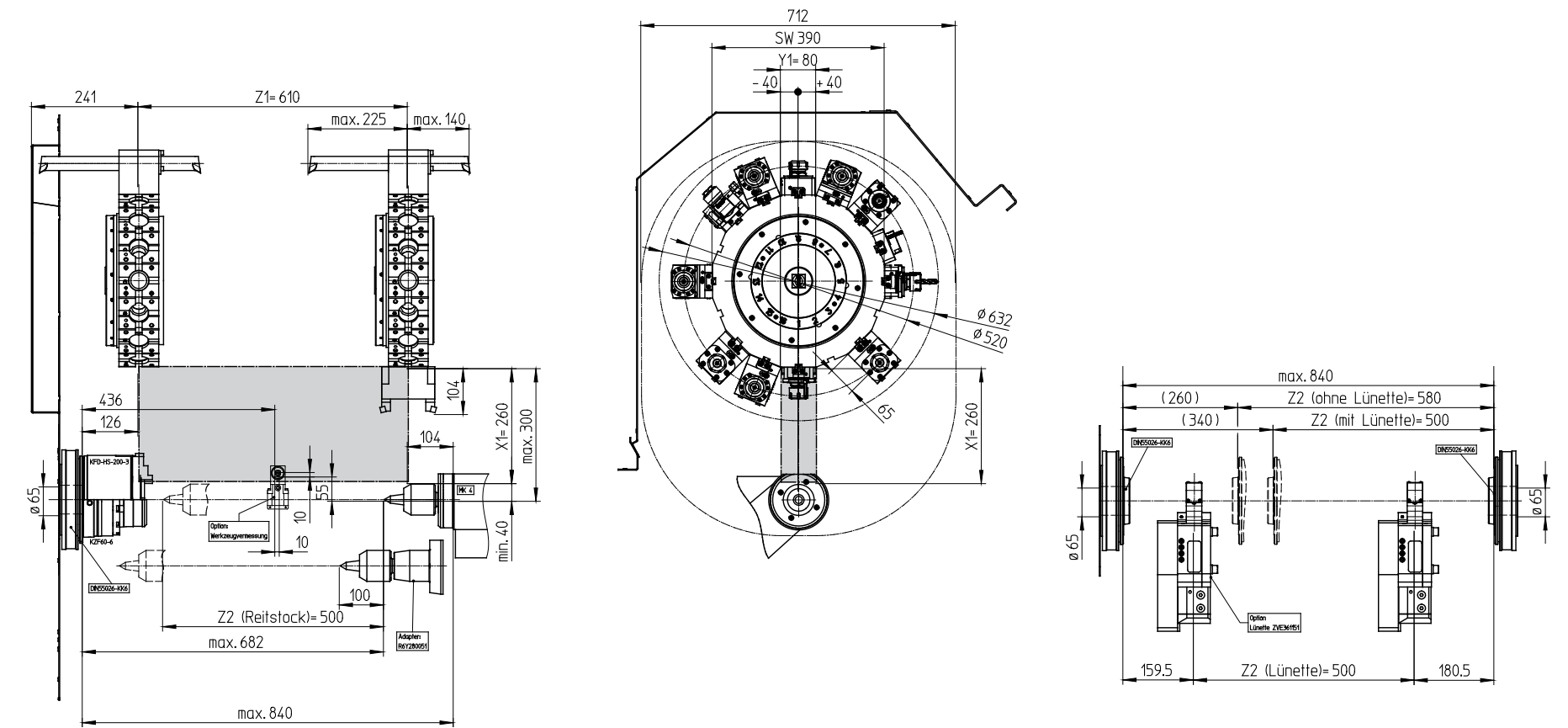

Indications in millimeters

TECHNICAL DATA

Work area

Swing over bed	Ø 725 mm
Swing over slide	Ø 400 mm
Distance between centers in tailstock version	682 mm
Main spindle / counter spindle distance	840 mm
Maximum turning diameter	Ø 500 mm
Maximum part length	520 mm
Maximum bar diameter	Ø 65 (76,2/95) mm

Travel

Travel in X / Z	260 / 610 mm
Travel in Y	80 (+/-40) mm

Main spindle (ISM)

Speed range	0 – 5000 (4000/3500) rpm
Maximum drive power	29 (29/37) kW
Max. torque on the spindle	250 (250/360) Nm
Spindle nose DIN 55026	A2-6 (A2-8/A2-8)
Spindle bearing (inner diameter at front)	105 (130/140) mm
Spindle bore hole	Ø 73 (86/106) mm

Counter spindle (ISM)

Speed range	0 – 6000 rpm
Maximum drive performance	22 kW
Max. torque on the spindle	130 Nm
Spindle nose DIN 55026	A2-6
Spindle bearing (inside diameter at front)	85 mm
Spindle bore hole	53 mm

Tailstock

Tailstock travel	500 mm
Maximum contact pressure	8000 N
Maximum travel speed	approx. 20 m/min
Inner cone for taking up the roller centre punch	MT 4

C-axis

Round axis resolution	0,001°
Rapid motion speed	1000 rpm

Tool turret

Number of tool positions (all driven)	12
VDI shaft (DIN 69880)	30 (40) mm
Tool cross-section for square tools	20 x 20 (25 x 25) mm
Shaft diameter for boring bars	32 mm
Tool change time	0,2 (0,3) sec.

Driven tools DIN 5480

Speed range	0 – 5000 (4500) rpm
Maximum torque	25 Nm
Maximum drive power	6,7 kW

* For machines including laser measurement and pitch error compensation

Tool turret with BMT interface and direct drive

Number of tool positions	12 / 16
Precision interface	BMT55-P / BMT45-P
Tool cross section for square tools	25 x 25 / 20 x 20 mm
Shank diameter for boring bars	40 / 32 mm
Tool change time	0,5 sec.
Speed range	0 – 12000 rpm
Max. torque	28 / 25 Nm
Max. drive power	11,7 kW

Feed drives

Rapid motion speed X / Y / Z	30 / 15 / 30 m/min
Feed force in the X / Y / Z	5000 / 7000 / 7000 N
Feed force in the Z2 axis (counter spindle)	8000 N
Positioning scatter Ps VDI 3441 in X / Y / Z	2 / 2 / 2 µm *

Coolant system

Tank volume (optional)	230 (250/720) liters
Coolant pressure (optional)	3,5 (14 / 25) bar
Pump power (optional)	0,57 (2,2 / 3) kW

Power consumption

Connected load	40 kVA
Compressed air	6 bar

Dimensions and weight

Height of spindle center above floor	1180 mm
Machine height	2405 mm
Machine footprint L x D	3350 x 2330 mm
Total weight	approx. 7000 kg

EMCO SL1200

Bar length	250 – 1200 mm
Bar diameter	Ø 8 – 95 mm
Material support	ca. 560 mm
Length	1700 mm
Width	1250 mm
Height (Spindle center)	1090 – 1380 mm
Weight approx.	ca. 500 kg

Safety devices CE compliant

beyond standard /

EMCO GmbH / Salzburger Str. 80 / 5400 Hallein-Taxach / Austria / T +43 6245 891-0 / F +43 6245 86965 / info.at@emco-world.com

www.emco-world.com