

EMCO CAMConcept M

Software description - software version 2.0 or higher

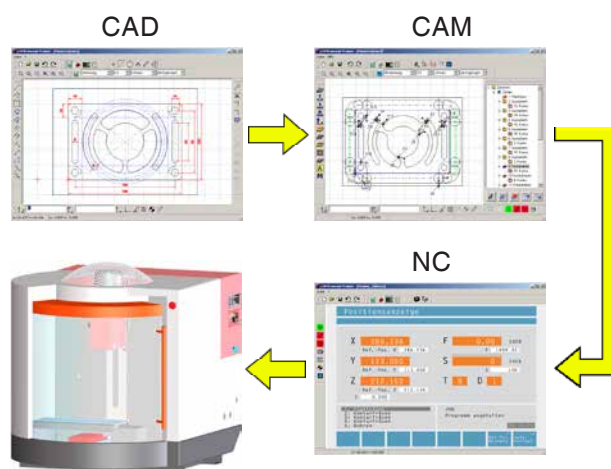

Software description EMCO CAMConcept Milling

Ref.No. EN 1828
Edition D 2014-05

This instruction manual is also available on the
EMCO homepage in electronic form (.pdf).

Original instruction manual

EMCO GmbH
P.O. Box 131
A-5400 Hallein-Taxach/Austria
Phone ++43-(0)62 45-891-0
Fax ++43-(0)62 45-869 65
Internet: www.emco-world.com
E-Mail: service@emco.at





Note:

This software description contains a description of all functions which can be carried out with CAMConcept.
Depending on the machine you are running with CAMConcept, not all of these functions will necessarily be available.

EC conformity



The CE mark certifies, together with the EC declaration of conformity, that the machine and the guidelines are in conformity with the regulations of the directives applicable to the products.

All rights reserved, duplication is permitted only by prior authorisation of EMCO GmbH
© EMCO GmbH, Hallein

CAMConcept didactics

Today, NC machines are programmed in practice via automatic contour programming. Nonetheless, it is still necessary for experts in the field to understand the automatically generated NC program.

CAMConcept offers a consistent didactic concept, starting from the simple generation of workpiece contours in CAD mode, through automatic, interactive generation of the NC program in CAM mode right up to execution of the NC program on a connected NC machine. Thanks to the fully developed online help functions, CAMConcept is perfect for training.

CAMConcept - performance scope

- Easy-to-use graphical user interface
- Creation of CAD workpiece contours
- Adjustable clamping devices and unmachined parts
- Automatic contour programming
- Cycle support
- NC program editor
- Status indicators of the programmed machine states
- Tool library
- Import, export interfaces
- Measurement of clamping devices and tools
- Support for multiple control and machine types
- Online NC machine functions
- Online help functions
- 2D machining simulation
- 3D machining simulation

Assumed knowledge

Users working with CAMConcept are expected to be familiar with the operation of MS Windows and understand the handling and basic programming of the connected NC machine. Please consult the corresponding manuals if necessary.

Learning goals

CAMConcept teaches the following learning goals:

- Drawing and modifying CAD contours
- Automatic, interactive generation of NC programs
- Changing existing NC programs
- Understanding the connections between the NC machine settings and NC programming
- Operation of an NC machine

Structure of the literature

The CAMConcept software description has the following structure:

- General basic principles of operation
- Description of menu bars
- CAD commands
- CAM commands
- NC commands
- Operations scheduling

With its comprehensive user guidance (online help and explanations in the status bar) CAMConcept is designed so that the software description is only rarely needed.

Contents

CAMConcept didactics	3	D: CAD Commands	D1
CAMConcept - performance scope	3	CAD mode	D1
Assumed knowledge	3	Redraw	D1
Learning goals	3	Coordinate menu	D2
Structure of the literature	3	Cartesian / polar coordinate system	D2
		Insert point	D4
		Catch mode and snap points	D4
		Set zero point.....	D5
		Cancel zero point.....	D5
		Ruler	D5
A: Basic principles	A1	Creating elements	D6
Launching CAMConcept.....	A1	Point menu.....	D6
Help function.....	A1	General	D6
CAD screen layout.....	A2	Point.....	D6
CAM screen layout	A3	Cross-shaped	D6
Window divisions	A4	Quadratic	D6
CAMConcept main window.....	A4	Circular	D6
CAMConcept window	A4	Line menu	D7
Menu lines	A4	Draw line.....	D7
		Line properties window	D7
		Poly line	D8
		Rectangle.....	D9
		Rotated rectangle 1 (starting point/angle/length/width) ...	D9
		Rotated rectangle 2 (center/angle/length/width)	D9
		After the input of the center you have to enter the angle, by which the rectangle is rotated.	D9
		Parallel with point indication	D10
		Parallel with distance	D10
		Perpendicular.....	D11
		Chamfer (length).....	D11
		Chamfer (distance/distance).....	D12
		Tangent (point/circle)	D13
		Tangent (circle/circle)	D13
		Circle menu.....	D14
		Circle with circle center and radius	D14
		Circle properties window.....	D14
		Circle with centre and point on the circumference.....	D15
		Concentric circles	D16
		Circular arc with starting point, target point and circle point . D16	
		Circular arc with starting point, target point and radius..	D17
		Circular arc with starting point, target point and center .	D17
		Insert radius	D18
		Rounded off elements.....	D19
		Text menu.....	D21
		Text at point	D21
		Text on line	D21
		Text on arc	D21
		Dimensioning menu	D23
		horizontal dimensioning	D23
		vertical dimensioning	D23
		free dimensioning	D23
		dimensioning of angles	D23
		dimensioning of diameter.....	D23
		dimensioning of radius.....	D23
		Dimension settings	D23
		Symbol menu.....	D25
		Creating categories.....	D25
		Creating symbols	D26
		Change menu	D27
		Selecting an element	D27
		Cutting an element.....	D27
		Trimming 1 element	D28
		Trimming with 2 elements.....	D29
		Creating hatching.....	D30
B: Operating sequences	B1		
Command symbols.....	B1		
Undo / Redo.....	B1		
Zoom commands.....	B2		
AutoZoom	B2		
ZoomBox	B2		
Zoom undo.....	B2		
Set new center.....	B2		
Zoom in.....	B2		
Zoom out.....	B2		
Layer.....	B3		
Calculator in input fields.....	B4		
PC keyboard.....	B5		
Overview Button Assignment Machine Operating ElementsB7			
C: Menu lines	C1		
Menu "File"	C1		
New.....	C1		
Open	C1		
Save.....	C1		
Save as	C1		
DXF import.....	C2		
DXF export.....	C2		
NC export.....	C2		
Save image.....	C3		
Close.....	C3		
Recently opened files	C3		
Menu "?"	C4		
Information	C4		
Help	C4		

Delete	D31	Simulation single block on/off	E76
Shifting an element absolutely or incrementally	D31	Alarms of the 3D simulation	E77
Shifting and copying an element absolutely or incrementally	D32	Cycle lists	E77
Rotate	D33	3D-simulation settings	E78
Rotating and copying	D34	Zoom commands for the simulation	E80
Mirroring	D35	Tool modelling with the 3D-Tool Generator	E81
Mirroring and copying	D36	Generating a new tool	E82
Scaling	D37	Copying a tool	E82
		Changing an existing tool	E83
		Selecting a tool colour	E83
		Visualizing a tool	E84
		Sorting function	E85
E: CAM commands.....	E1		
CAM mode	E1		
Restructuring	E1		
Generating	E2	F: NC commands.....	F1
Settings	E2	NC part	F2
Machine	E2	Working through the NC program	F2
Tool measurement	E3	Screen layout for an NC part	F2
Unmachined part	E8	NC start	F3
Entering a contour	E10	NC reset	F3
Contour tracking – segments	E10	NC stop	F3
Contour tracking – elements	E10	Single block on/off	F3
Contour tracking – text	E11	Dryrun	F3
Save contour	E11	Reference the machine	F3
Cancel contour	E11	Command advance	F4
Define new starting point	E12	Periphery	F5
Change direction	E12	Spindle counter-clockwise	F5
Hole pattern	E13	Spindle stop	F5
Save hole pattern	E13	Spindle clockwise	F5
Cancel hole pattern	E13	Open / close clamping device	F5
Cycles	E14	Blowing-out device on / off	F5
Defining cycles	E14	Automatic door open / close	F6
2D-Simulation	E15	Coolant on / off	F6
Input of geometry data	E17	Next tool	F6
Taking coordinates of elements from the CAD drawing	E18	Auxiliary drives on / off	F6
Save elements	E18	Feed rate F [mm/min]	F7
Cancel elements	E18	Spindle speed S [rpm]	F8
Taking coordinates of points from the CAD drawing	E19	Traversing coordinate axes	F9
Save points	E19	Setting / resetting a reference point	F9
Cancel points	E19	Loading a new tool	F9
Input of technology data	E20		
Positioning	E21	G: Operations scheduling.....	G1
Positioning 2	E22	Operations scheduling	G2
Drilling 1	E23	Print tool table	G2
Drilling 2	E25	Print plans	G2
Drilling 3	E27	Plane setting	G3
Centering	E29		
Boring	E31	H: Alarms and Messages.....	H1
Raspings	E32	Machine Alarms 6000 - 7999	H1
Tapping Cycle	E34	PC MILL 50 / 55 / 100 / 105 / 125 / 155	H1
Thread milling	E36	Concept MILL 55 / 105 / 155	H1
Face milling	E38	PC TURN 50 / 55 / 105 / 120 / 125 / 155	H6
Slot milling	E41	Concept TURN 55 / 60 / 105 / 155 / 250 / 260 / 460	H6
Simple pocket	E44	Concept MILL 250	H6
Rectangular pocket milling	E47	EMCOMAT E160	H6
Circular pocket 1	E50	EMCOMAT E200	H6
Circular pocket 2	E52	EMCOMILL C40	H6
Rectangular stud	E55	EMCOMAT FB-450 / FB-600	H6
Circular stud	E58	Inputunit alarms 1700 - 1899	H17
Roughing out	E61	Axis Controller Alarms	H19
Contour milling	E64	8000 - 9000, 22000 - 23000, 200000 - 300000	H19
Engraving	E67	Axis Controller Messages	H26
Text milling point	E68		
Text milling line	E69		
Text milling circular arc	E70		
ISO cycle	E71		
Coordinate transformation	E73		
Simulation	E75		
Simulation NC start	E76		
Simulation NC reset	E76		
Simulation NC stop	E76		

Control alarms 2000 - 5999	H27
Fagor 8055 TC/MC	H27
Heidenhain TNC 426	H27
CAMConcept	H27
EASY CYCLE	H27
Sinumerik OPERATE.....	H27
Fanuc 31i	H27
Heidenhain TNC 640	H27

X: EMConfig X1

General.....	X1
How to start EMConfig.....	X2
How to activate accessories	X3
High Speed Cutting.....	X3
Easy2control on screen operation	X4
Settings.....	X4
Machine room camera	X5
How to save changes	X6
How to create machine data floppy disk or machine data USB flash drive	X6

Z: Software Installation Windows Z1

System prerequisites	Z1
Software installation.....	Z1
Variants of WinNC	Z1
Network card (ACC).....	Z2
Starting WinNC	Z3
Terminating WinNC	Z3
Checks by EmLaunch.....	Z4
Licence input.....	Z6
Licence manager	Z6

A: Basic principles

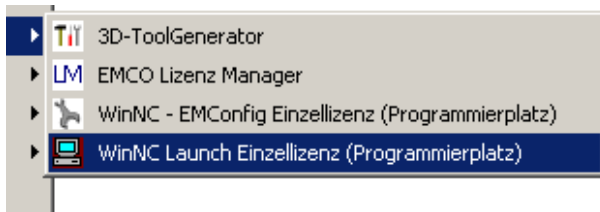

Launching CAMConcept

Launching CAMConcept

At this point we would like to refer the reader to the general aspects of Windows XP operation, which are not covered in this brochure. For more information please refer to the corresponding manuals for your operating system.

After Windows installation of CAMConcept, point the mouse at the WinNC Launch program icon (in the Windows Start menu) and click on it.

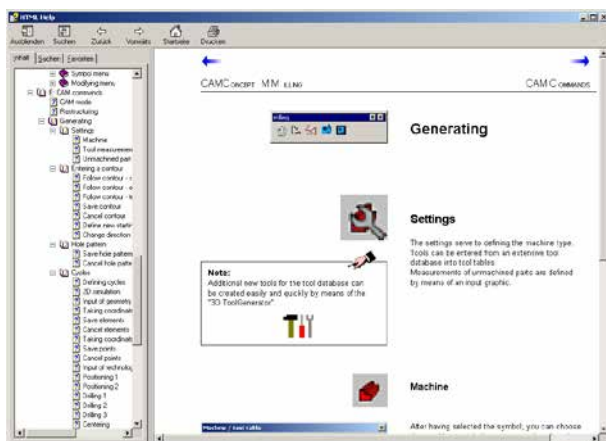

CAMConcept help with Contents pane

Help function

CAMConcept offers several online help functions which will provide the required assistance in any step:

- The full CAMConcept help function, which can be called up via the menu bar. This function offers a content listing which enables you to scroll back and forward through all of the help texts in the same way as you are used to from other Windows programs.
- CAMConcept keeps you constantly informed in the status bar at the bottom of the screen. Here you can see what kind of inputs CAMConcept is expecting from you.
- The CAMConcept help field (Shift + F1), which takes you directly to the required help.
- When you hover over a function with the mouse pointer, CAMConcept displays the name of the function.

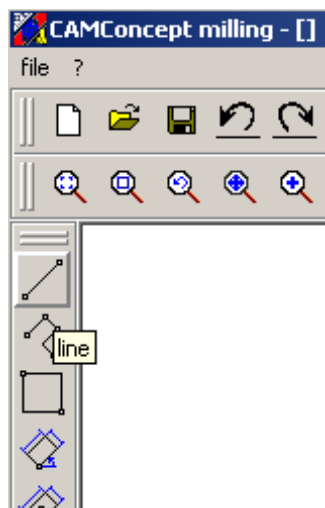

Name of the function

CAD screen layout

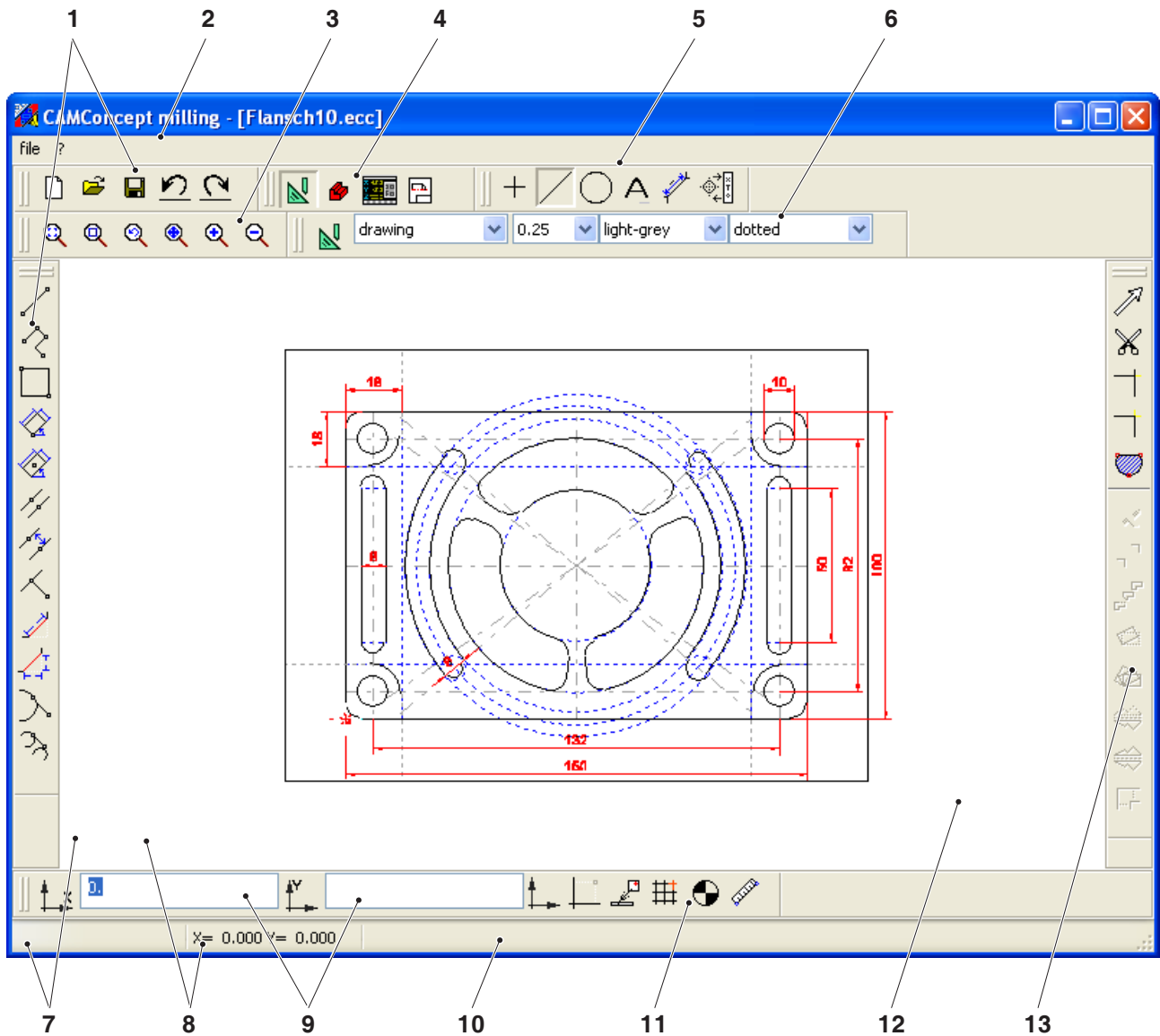

No.	Description	No.	Description
1	Command symbols	8	Current position message
2	Menu bar	9	Previous position message
3	Zoom commands	10	Status message / Help bar / Error message
4	Switchover between CAD-CAM-NC-AV modes	11	Coordinates menu
5	CAD menu commands	12	CAD window
6	Layer	13	Change commands
7	Input fields		

CAM screen layout

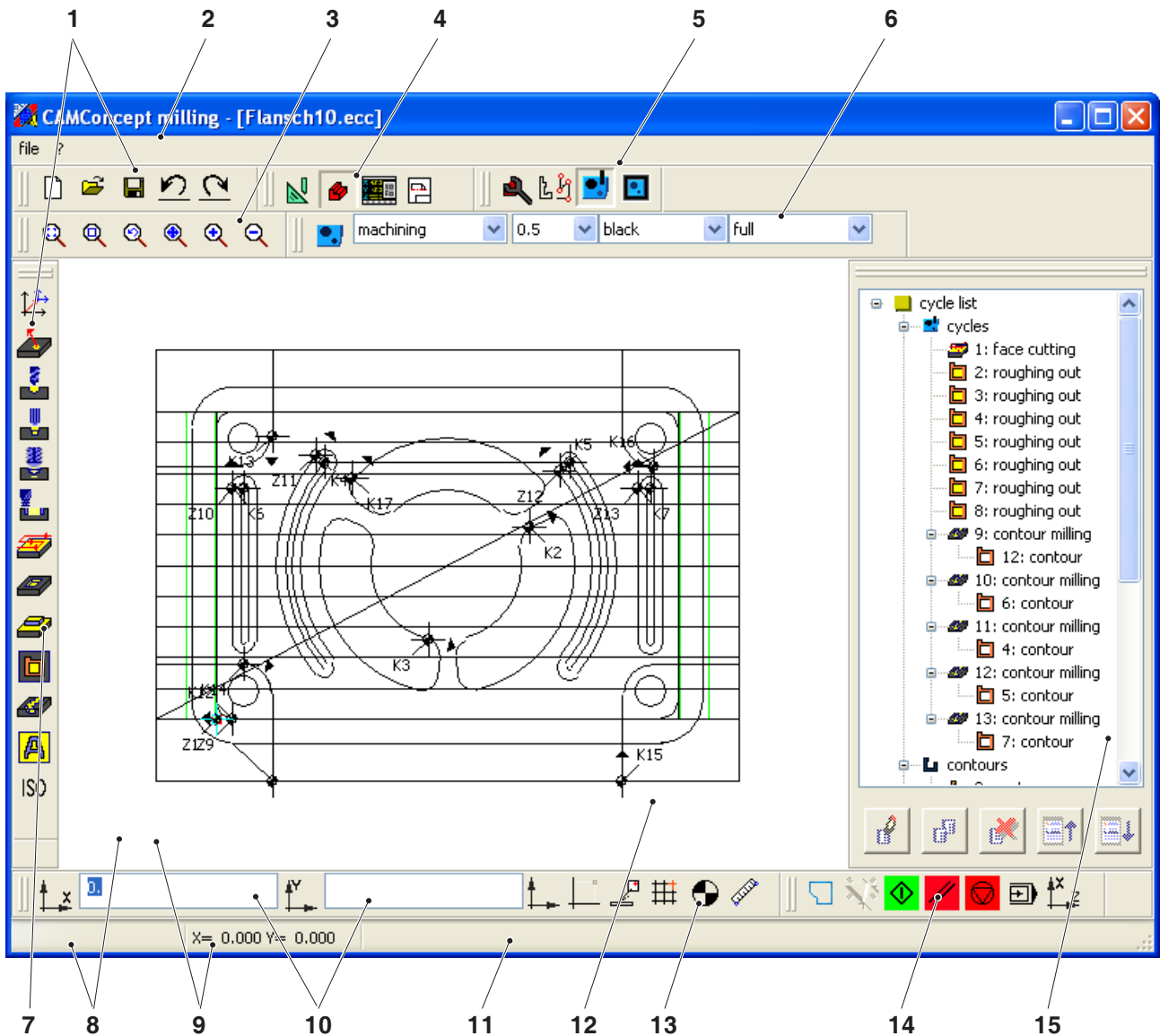

No.	Description	No.	Description
1	Command symbols	9	Previous position message
2	Menu bar	10	Input fields
3	Zoom commands	11	Status message / Help bar / Error message
4	Switchover between CAD-CAM-NC-AV modes	12	CAM window
5	CAM menu commands	13	Coordinates menu
6	Layer	14	2D simulation
7	Cycle commands	15	CAM editing window
8	Current position message		

Window divisions

CAMConcept main window

After having been started, CAMConcept will appear with its main window. In the working area of the main window additional windows are possible.

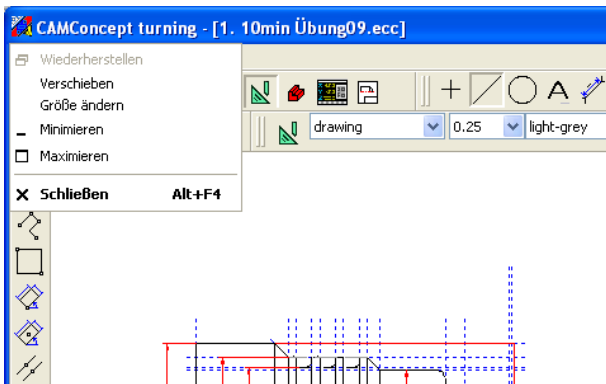

CAMConcept main window

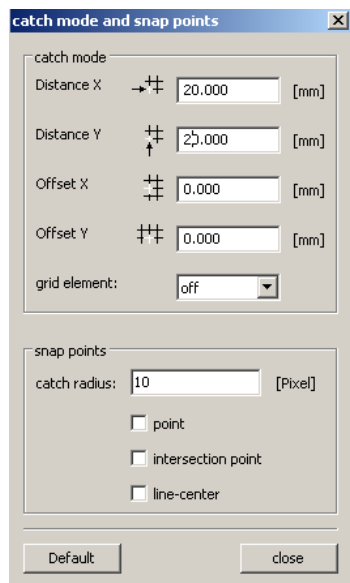

CAMConcept window

CAMConcept window

CAMConcept windows serve to either provide information (e.g. information about CAMConcept) or to enter specific parameters (e.g. properties of lines). These windows can only be moved.

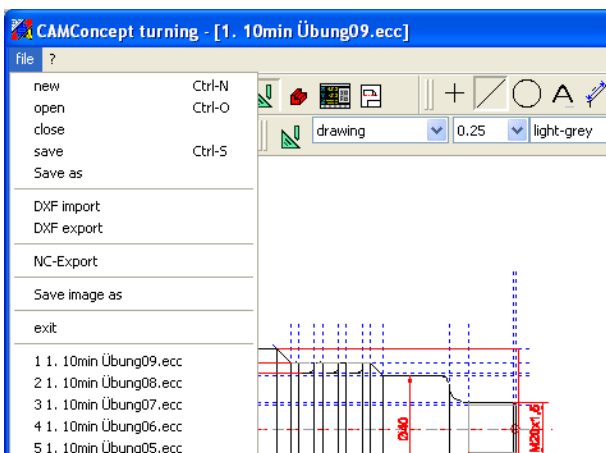

Menu name

Menu lines

By clicking on a menu name a list of commands that can be selected (standard font) and of those being currently blocked (diffuse, matrix font) will be displayed.

B: Operating sequences

You can maximize, minimize windows or go back to normal window size by means of the window symbols. Make a double click on the text display of the status line to switch between the normal and the maximized window size.

Command symbols

Display of symbols

When you have selected a command symbol with the mouse button (which means it is active), the symbol appears shaded.



Icon inactive



Icon active

The symbol will remain active until

- the command is carried out (direct command symbols)
- the command is deselected by another one (menu commands and shift symbols)
- the command is cancelled by pressing the right mouse key.

Note:

Press the right mouse button when you wish to return to the respective superordinate menu.

It is possible to change the properties of an element later in the CAD mode by means of the right mouse button.



Undo / Redo



Use the symbol "Undo" to cancel the last operating commands.

The symbol "Redo" enables to cancel already cancelled operating commands.

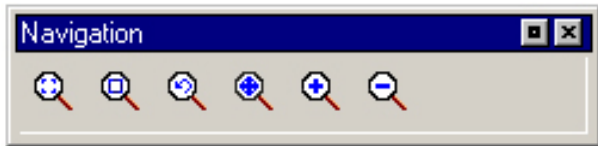

Zoom commands

The navigation bar enables to zoom and move the simulation image. Prior to selecting a symbol, press the left mouse button in the drawing window once.

AutoZoom

Zooms the display area automatically in or out to window size.



ZoomBox

After selection of the symbol use the mouse to draw a selection rectangle around the elements you wish to zoom in and press the left mouse button.



Zoom undo

You can cancel the last zoom command by means of the command "Zoom undo".



Set new center

After selection of the symbol the mouse pointer changes into a 4-way arrow. Use the mouse to select the new center of the drawing. The drawing will be centered around the drawing center that has been selected.



Zoom in

After selection of the symbol the view is zoomed in by one step. You can also use the mouse wheel or the key to zoom in.

If you wish to make extensive magnifications, it is easier to use the symbol "ZoomBox".



Zoom out

After selection of the symbol the view is zoomed out by one step. You can also use the mouse wheel or the key to zoom out.

If you wish to make extensive reductions, it is easier to use the symbol "AutoZoom".

Layer

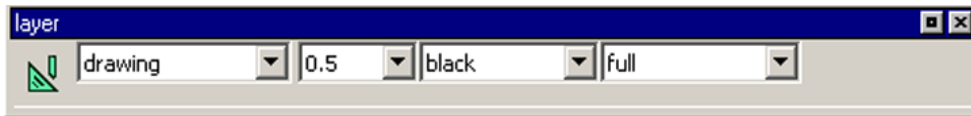

Layer selection window in CAD mode



Layer selection window in CAM mode

The layer window enables the definition of different line attributes.

You can choose among several layers.

Here you can set the line width, the line colour and the line form of the lines being displayed in the CAD, respectively in the CAM mode.

Prior to drawing the elements, please select the line attributes.

In the CAD mode you can later alter the properties of an element by means of the right mouse button.

Calculator in input fields

With the aid of the calculator, mathematical expressions can be calculated directly in an input field.















Any number of parenthesis levels can be used in the expressions.

To calculate the expressions, press the "Enter" key or exit the input field.















In the event of errors during calculation of a formula, the last entered expression is displayed and CAMConcept outputs an error message.

Command	Meaning	Example	Result
+	Addition	1+1	2
-	Subtraction	3-2	1
*	Multiplication	5*3	15
/	Division	15/3	5
%	Modulo function (division remainder)	10%4	2
^	Power	5^2	25
PI	Pi; the ratio of the circumference of a circle to its diameter	PI	3.141593
SIN()	Sine function	SIN(90)	1
ASIN()	Arc sine function	ASIN(-1)	-90
COS()	Cosine function	COS(90)	0
ACOS()	Arc cosine function	ACOS(-1)	180
TAN	Tangent function	TAN(45)	1
ATAN	Arc tangent function (value)	ATAN(1)	45
ATAN2(;)	Arc tangent (X-section; Y-section)	ATAN(0;1)	0
EXP()	Exponential function (base e)	EXP(1)	2.718282
LOG()	Logarithm function (base e)	LOG(5)	1.609
SQRT()	Square root function	SQRT(2)	1.414
MOD(;)	Modulo function	MOD(10;4)	2
TRUE	Logically true	TRUE	1
FALSE	Logically false	FALSE	0
AND	AND operation	1AND1	1
OR	OR operation	1OR1	1
NOT	Negation	NOT(1OR1)	0

Functions of the calculator

PC key	Control system button	Function
		Single block
		Reset key (Reset)
 		Dryrun (test-run feed)
 		Selectable Stop
		Skip (block mask)
 		Call context-sensitive help

Overview Button Assignment Machine Operating Elements



PC key	Control elements	Function
Alt I		Internal/External Clamping (Option Concept Turn 55)
Alt O		Coolant / Purge on / off
Alt P		Door open / closed
Alt H		Clamping device closed
Alt J		Clamping device open
Alt K		Swivel tool holder
Alt X		Feed Stop
Alt C		Feed Start
Alt V		Spindle Stop
Alt B		Spindle Start
Alt N		Switch auxiliary drives on AUX OFF
Alt M		Switch auxiliary drives off AUX ON
Enter		NC Start
,		NC Stop

Note:

Selecting the machine buttons via the PC keyboard:

- 1.) Hold "Alt" button down.
- 2.) Press and then release machine button.
- 3.) Release "Alt" button.

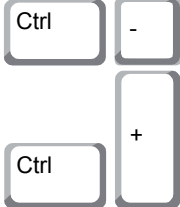

PC button	Control elements	Function
		Spindle speed correction
		Override (feed rate override)

C: Menu lines

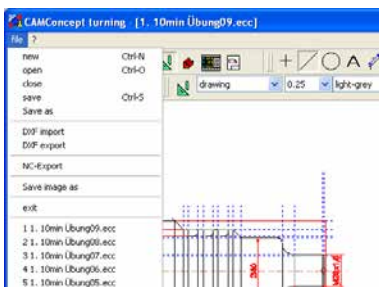

Menu "File"

New

Click on this symbol to open a new project. In case there is a drawing already being displayed on the screen, it will either be saved or deleted after a safety query.



Menu "File"

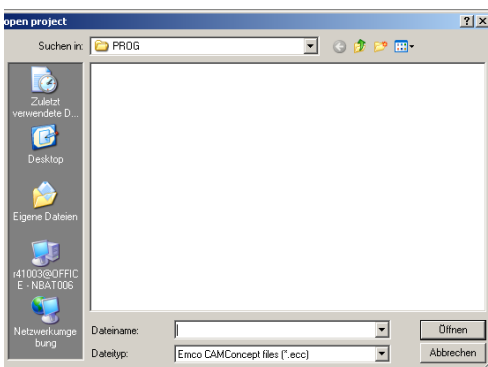

Open

With "Open" an existing project file will be opened. The Windows file window appears on the screen for the selection of CAMConcept project files. In case there is a project already being displayed on the screen, it will either be saved or deleted after a safety query.



Menu "Open file"

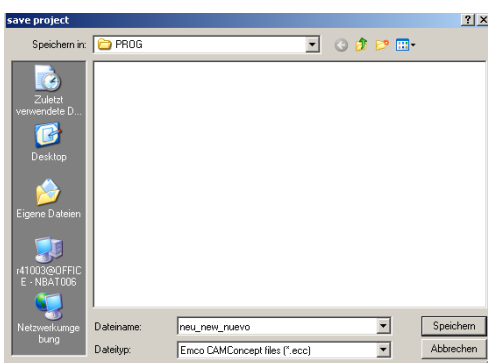

Save

The whole project is automatically saved under the same file name, under which it has been opened. For a new project that has not been saved yet, the Windows file window is automatically opened for input, respectively selection (see "Save as").

Save as

With this menu the whole project is saved under a new file name. The Windows file window appears for input, respectively selection.

Menu "Save file"



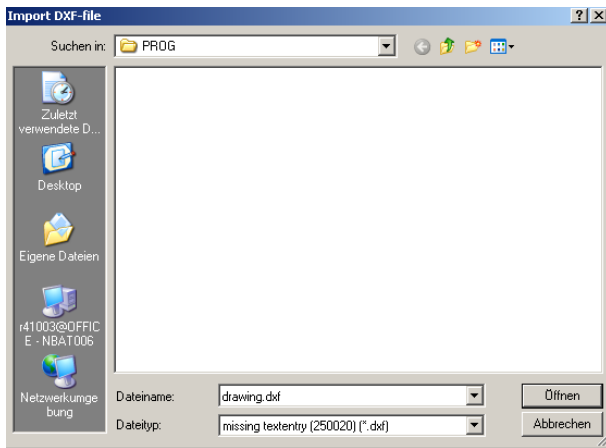

Menu "File, DXF import"

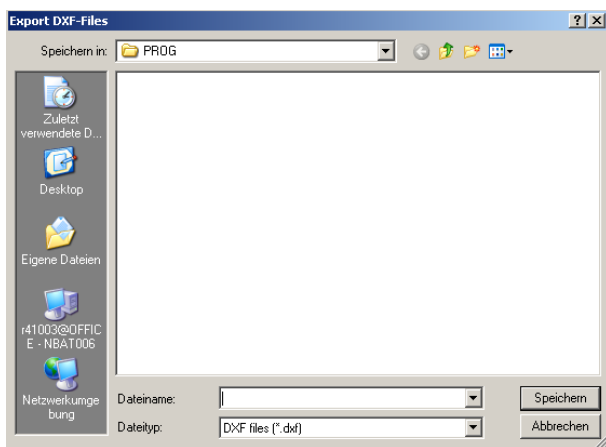

Menu "File, DXF export"

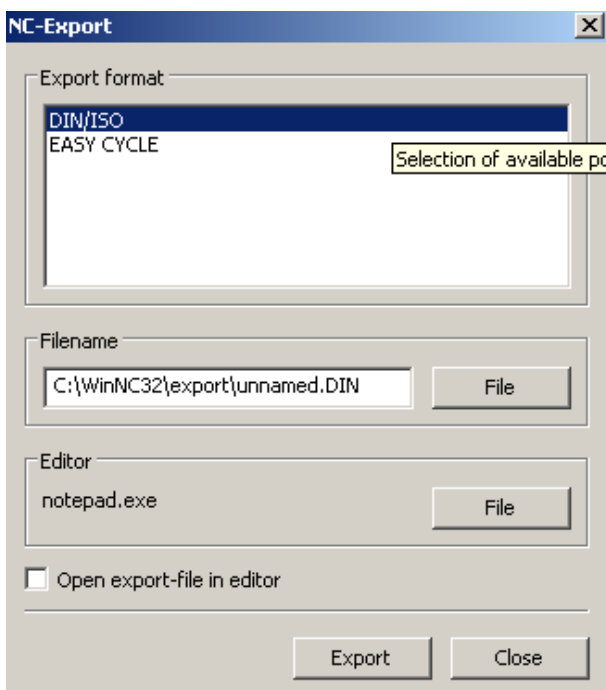

Menu "File, NC export"

DXF import

With DXF import DXF files can be directly called into the CAD mode, where they can be edited.

Note:

It is not possible to import splines.



DXF export

DXF export enables to convert a drawing that was created in the CAD mode into a DXF file.

NC export

This is used to export an NC program. Choose the correct export format. Specify the file name for the export file. Choose the editor with which the exported file is to be opened for further processing. Choose whether the export file should be opened in the editor after exporting.

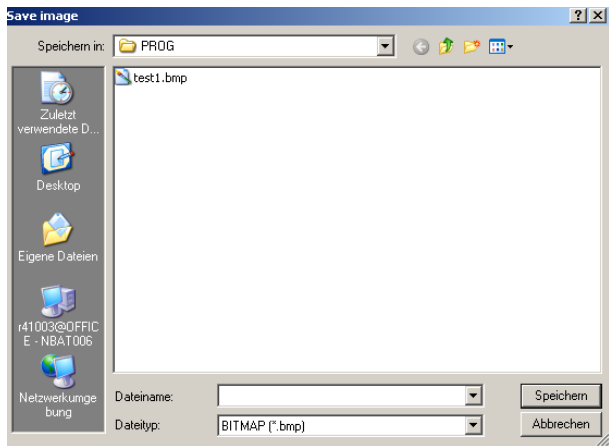

Menu "File; Save image"

Save image

This is used to save a screenshot of the drawing. A Windows file window pops up in which the file name can be entered and the image format can be selected.

The image can be saved as one of the following file types: *.bmp, *.jpg or *.png.

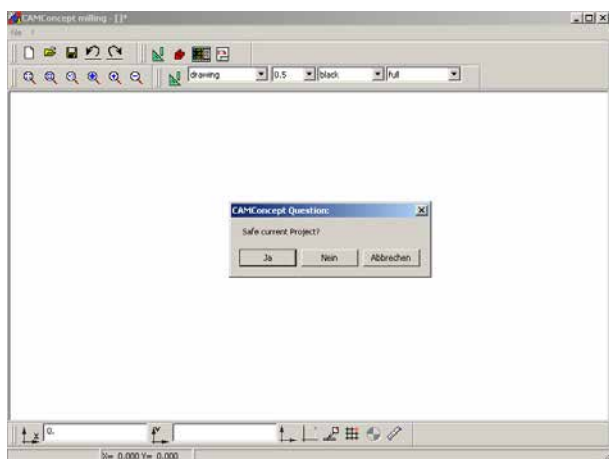

Menu "Close file"

Close

After a safety query the CAMConcept window will be closed and the program will be terminated.

Other possibilities to terminate the program are to close the CAMConcept window by pressing ALT+F4 or to end the task. For detailed information please consult your Windows manual.

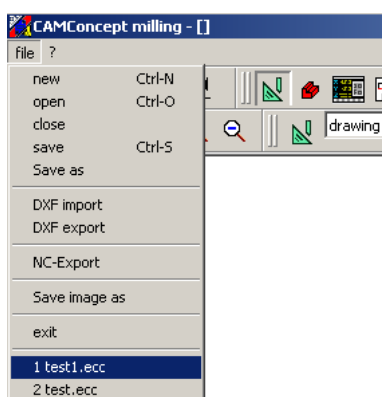

Menu "File;
Recently opened files"

Recently opened files

At the bottom of the "File" menu you will see a list of the files you have opened most recently with CAMConcept.

You can click on these with the mouse to open them directly.

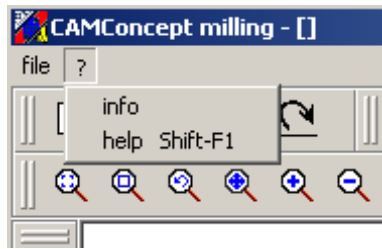

Menu "?"

Menu "?"

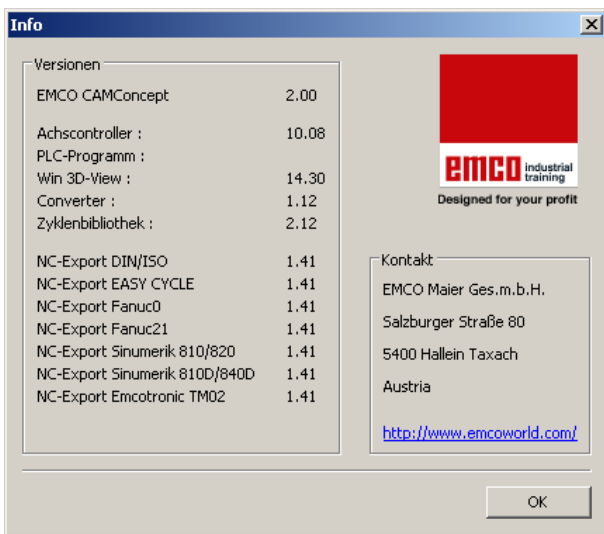

Menu "?", Information"

Information

The CAMConcept information window pops up with the software version number.

Note:

The number and values of the displayed version numbers may vary according to the configuration of the program and the selected machine.

Help

You can call up the context-sensitive help by pressing Ctrl + F1.



D: CAD Commands

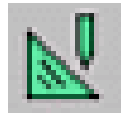

CAD mode

The CAD command symbols are activated by clicking on the shift symbol "CAD". The CAD mode will remain active until it is deselected by CAM, NC or operations scheduling. After the start of CAMConcept the CAD mode will be automatically activated.

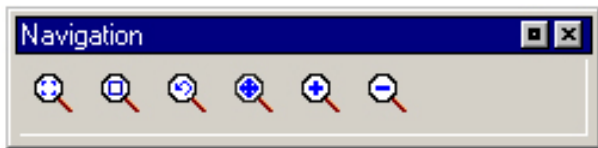

The zoom commands are described in chapter B.

Note:

You return to the respective superordinate menu by pressing the right mouse button. In the CAD mode the properties of an element can be changed later by means of the right mouse button.

Note:

Please confirm all value entries with "ENTER".



Redraw

The screen is redrawn after the F5 key is pressed.

After using the "Delete" or "Change" functions, it is possible that some lines on the screen are only displayed incompletely. In this case you should use the "Redraw" function or the zoom commands in order to refresh the screen display.

Coordinate menu

Cartesian / polar coordinate system

When the production drawing is dimensioned in Cartesian coordinates, you also write the part program using Cartesian coordinates. When workpieces have circular arcs or angles, it is often easier to define the dimensions with polar coordinates.

Polar coordinates have their datum in the circle center (CC), or pole. A position in a plane can be clearly defined by the

- polar radius (PR): distance from the circle center CC to the position, and the
- polar angle (PA): size of the angle between the angle reference axis and the line that connects the circle center CC with the position.

Definition of pole and angle reference axis:

The pole is defined by entering two Cartesian coordinates in one of the three planes. These coordinates also define the angle reference axis for the polar angle PA.

Pole coordinates (plane)	Polar axis
X/Y	+X
Y/Z	+Y
Z/X	+Z

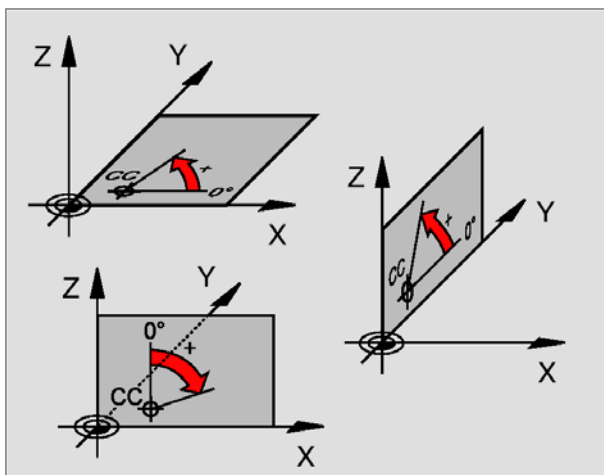
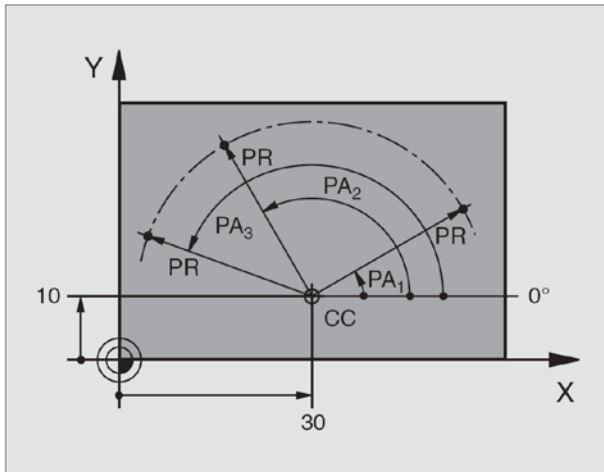
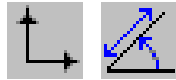

Absolute and incremental positioning

Absolute Cartesian position



If the coordinates in a position relate to the zero point of the coordinate system (origin) then they are referred to as absolute coordinates. Every position on a workpiece is uniquely defined by its absolute coordinates.

Incremental Cartesian position



Incremental coordinates relate to the last programmed position.

Absolute polar coordinates



Absolute coordinates always relate to the pole and the polar axis.

Incremental polar coordinates



Incremental coordinates always relate to the last programmed position. The polar axis is always a horizontal (+Z axis).

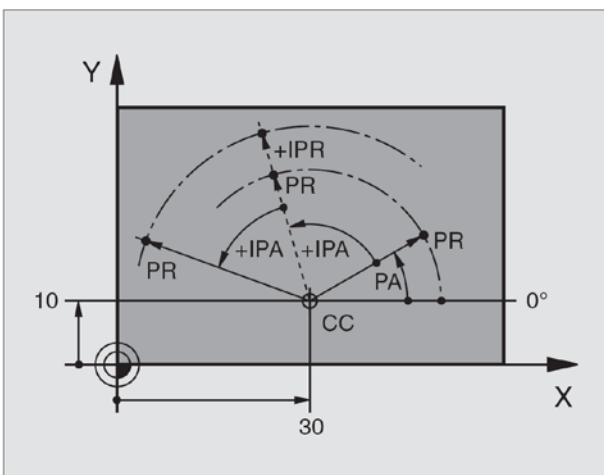



Insert point

After selection of the symbol the current position message will be entered into the input box.



Catch mode and snap points

Grid elements or grid lines are inserted to support the orientation and the drawing process. The grid starts in the reference point. The grid elements or the grid lines have the distances in horizontal and vertical direction as indicated in the input box shown opposite.

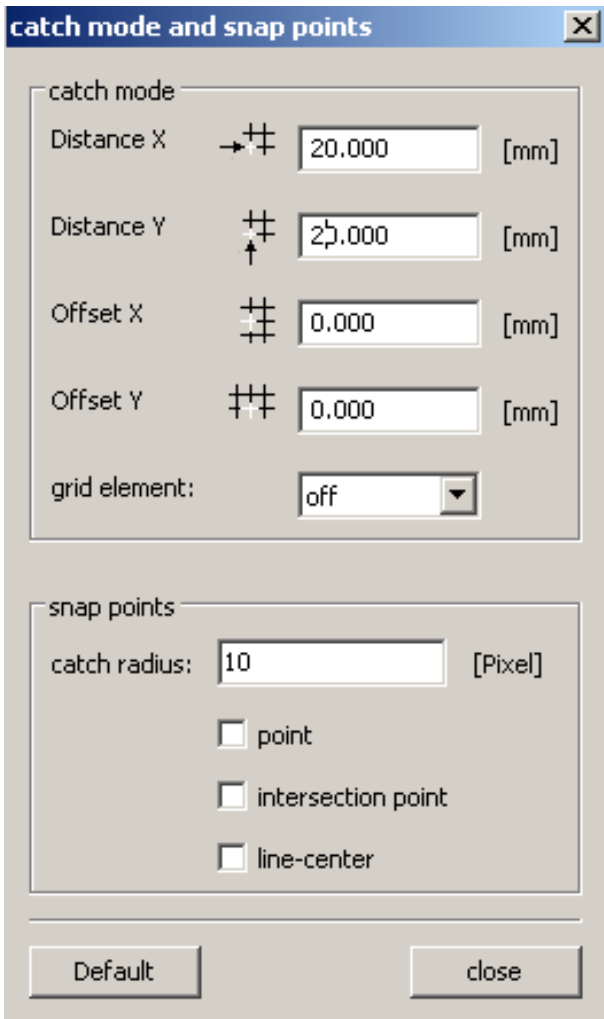

A grid that has already been defined can be additionally shifted vertically and/or horizontally. The grid can be displayed either as lined, dotted or inactive grid.



Catch radius

The catch radius is the area around the cursor cross which is searched by CamConcept when selecting elements.

Enter the catch radius in the input box.



Set zero point

The CAD zero point is automatically set in the center of the drawing window. This function enables to shift the zero point and thus the coordinate system from its present position.

After selection of the symbol use the left mouse button to position the new zero point at the required position.



Cancel zero point

When you select this symbol, the zero point that has been set will be cancelled



Ruler

The ruler serves to measuring the geometrical data in the CAD mode.

After selection of the symbol a window as shown in the illustration opposite will appear.

Press the left mouse button to select the starting point and the end point of the length to be measured.

Measuring distance between 2 points [X]

Measuring points

Startpoint P1

X Z

Endpoint P2

X Z

Result

Distance [mm]

Angle [degree]

close

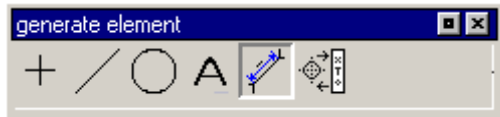

Creating elements

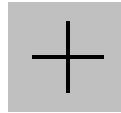

Point menu

General

After having selected the respective point symbol, please enter the position. This can be carried out by one of the following ways:

1. present cursor position and mouse click
2. by means of the the catch-mode menu (see catch grid and snap points) and mouse click
3. input of coordinates (see coordinate menu)

Every point will be saved as design point.



Point



Cross-shaped



Quadratic



Circular

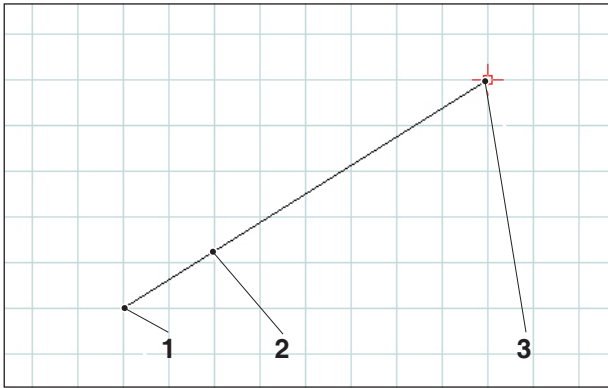
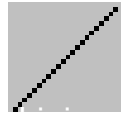

Drawing a line

Line menu

Draw line

After having selected the symbol, you have to enter the starting point of the line. This can be carried out by one of the following ways:

1. present cursor position and mouse click
2. by means of the catch-mode menu (catch grid and snap points) and mouse click
3. input of coordinates (see coordinate menu)

Then you have to enter the target point of the line.

The starting point and the target point of each line will be saved as construction points.

If you have to draw several lines that are connected with each other, you better use the command "poly line".

Item	Description
1	Starting point
2	Drawn line
3	End point

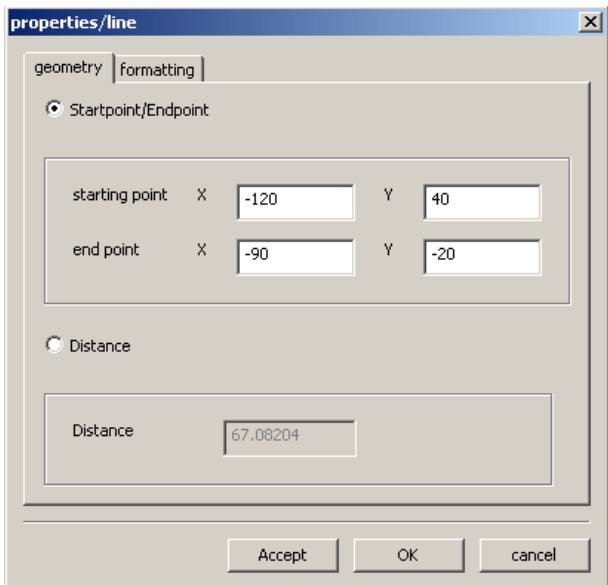

Line properties window

Line properties window

Note:

With the key combination CTRL + right-hand mouse button you can call up the properties window (Lines) and retrospectively change the line properties.

In the "Geometry" tab you can

- change the starting point/end point of the line by entering the coordinates. The length of the line is recalculated when the "Accept" button is pressed.

or

- change the properties of the line by entering the line length. The starting point remains the same, and the end point is shifted by the indicated value without changing the direction of the line.

The coordinates of the line are recalculated when the "Accept" button is pressed.

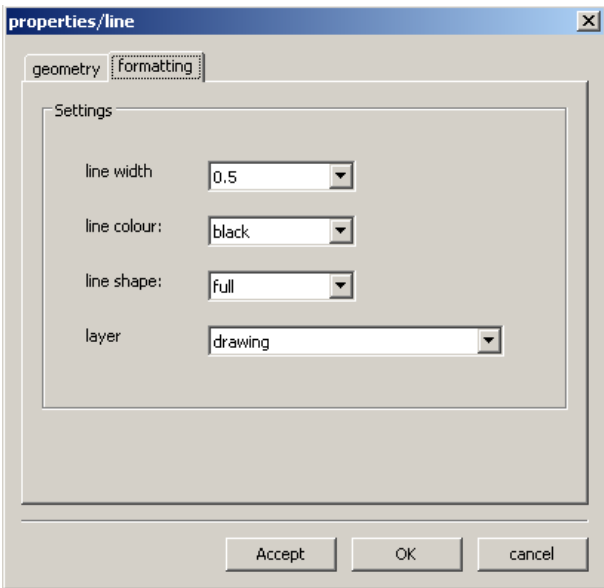

Line properties window

In the "Formatting" tab you can modify the following properties of the line:

- Line width
- Line colour
- Line shape
- Layer

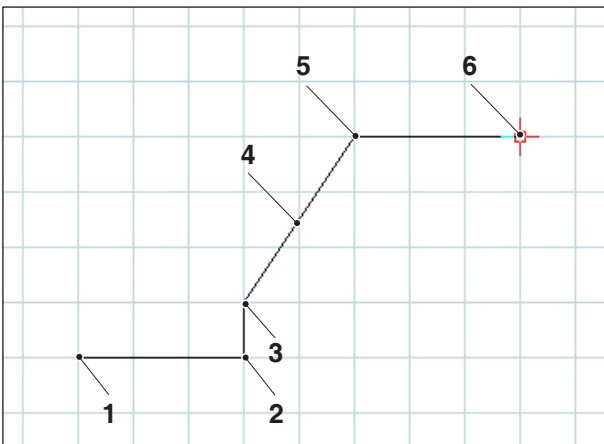

Poly line

Poly line

After the input of the starting point you have to enter the first target point. The first line of the poly line (polygon) will be drawn immediately. Now the command waits for the input of the next target point and so on.

Every point entered will be saved as design point.

The command is selfholding and must be interrupted (other command symbol, or press right mouse button).

Item	Description
1	Starting point
2	Point 1
3	Point 2
4	Polyline
5	Point 3
6	Point 4

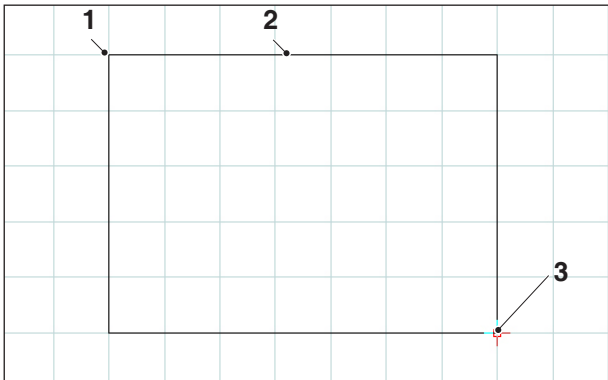

Rectangle

Rectangle

After the input of the starting point you have to enter the end point. The rectangle will be drawn immediately. Now the command waits for the input of the next starting point and so on.

Every point entered will be saved as design point.

Item	Description
1	Starting point
2	Rectangle
3	End point

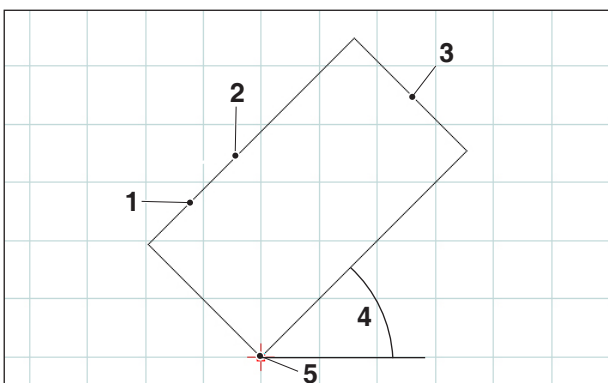

Rotated rectangle 1

Rotated rectangle 1 (starting point/angle/length/width)

After the input of the starting point you have to enter the angle, by which the rectangle is rotated.

Then, please enter the length and the width of the rectangle.

Every point entered will be saved as design point.

Item	Description
1	Length
2	Rotated rectangle 1
3	Width
4	Angle
5	Starting point

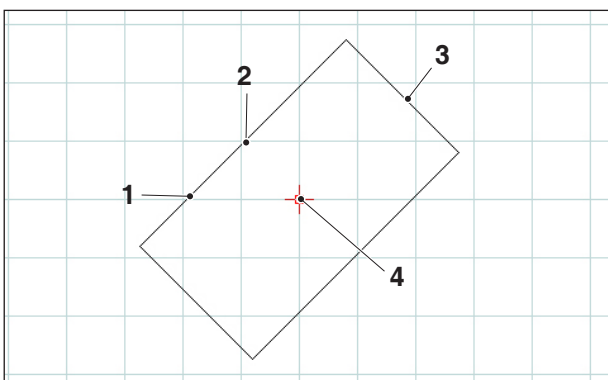

Rotated rectangle 2

Rotated rectangle 2 (center/angle/length/width)

After the input of the center you have to enter the angle, by which the rectangle is rotated.

Then, please enter the length and the width of the rectangle.

Every point entered will be saved as design point.

Item	Description
1	Length
2	Rotated rectangle 2
3	Width
4	Centre

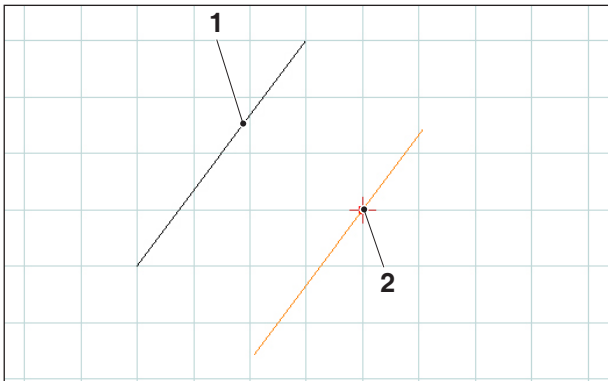

Parallel with point indication

Parallel with point indication

After having chosen the symbol, please select the element to be copied in parallel. The selected element changes its colour. Then you have to define a point across which the parallel shall run.

Both translated end points of the lines will be saved as design points.

Item	Description
1	Existing line
2	Parallel line through point

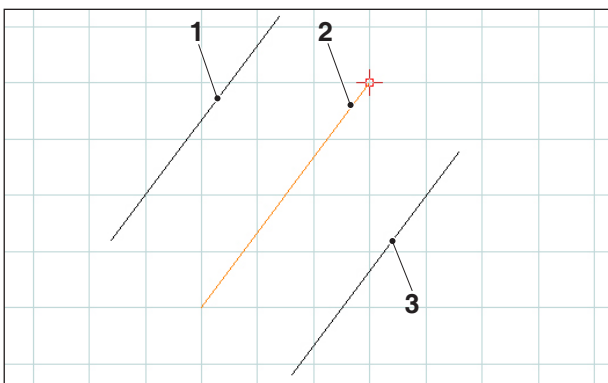

Parallel with point indication

Parallel with distance

After having chosen the symbol, please select the element to be copied in parallel. The selected element changes its colour. Then you have to enter the distance which the parallel shall observe.

Since we have two possible parallel lines here, you have to define the required parallel by entering an arithmetic sign (parallel 1 with a negative sign and parallel 2 with a positive one).

Both translated end points of the lines will be saved as design points.

Item	Description
1	Parallel line 1
2	Existing line (selected)
3	Parallel line 2

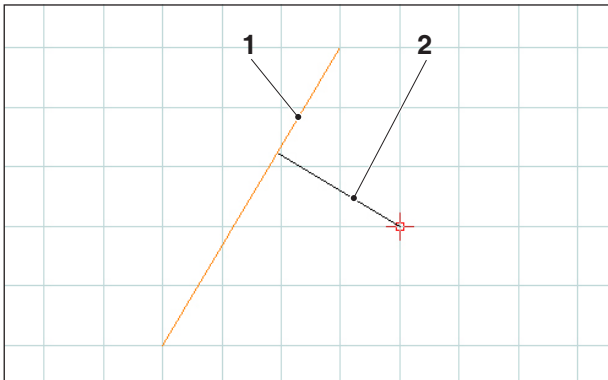

Perpendicular

Perpendicular

After having chosen the symbol, please select the element to be copied in parallel. The selected element changes its colour. Then you have to define a point across which the parallel shall run.

Both translated end points of the lines will be saved as design points.

Item	Description
1	Existing line (selected)
2	Perpendicular

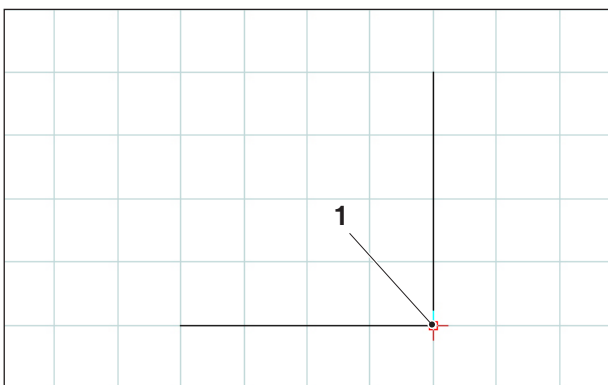

Edge point to be chamfered

Chamfer (length)

After having chosen the symbol, you have to select the lines where chamfer shall be inserted. The selected elements change their colour. Then you have to enter the length of the chamfer.

The two new design points resulting from the chamfer edge points will be saved. The previous edge point will be deleted.

Item	Description
1	Corner point
2	Chamfered corner point
3	Length of the chamfer

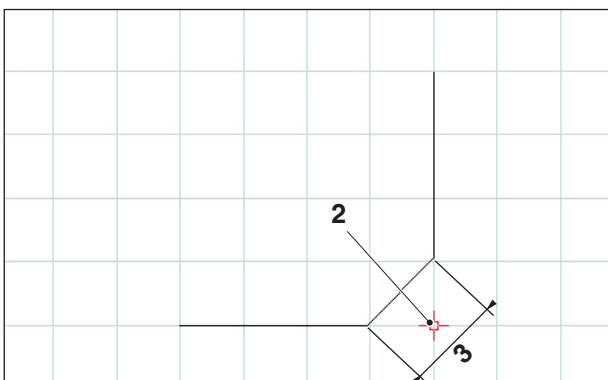

Chamfered edge point



Chamfer (distance/distance)

After having chosen the symbol, you have to select the lines where the chamfer shall be inserted. The selected elements change their colour. Then you have to enter the length of the chamfer in axis direction.

The two new design points resulting from the chamfer edge points will be saved.

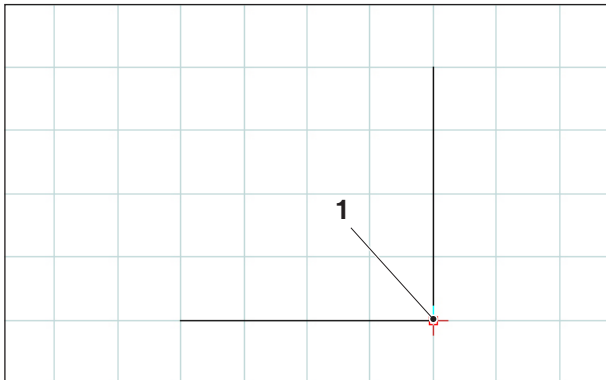

Edge point to be chamfered

Item	Description
1	Corner point
2	Chamfered corner point
3	Length of the chamfer in the direction of the axis

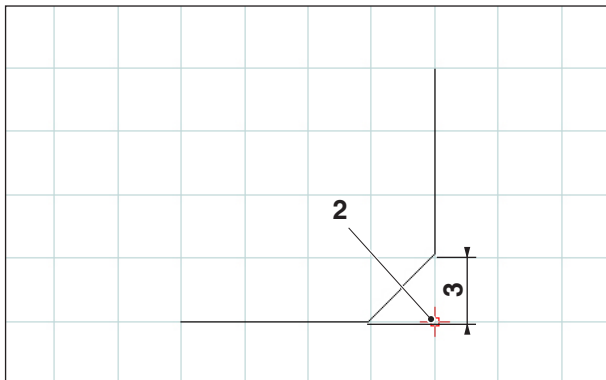

Chamfered edge point

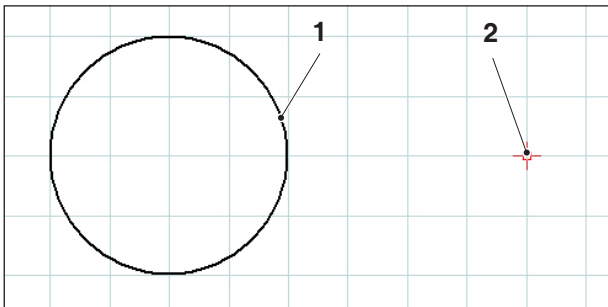

Tangent point – circle

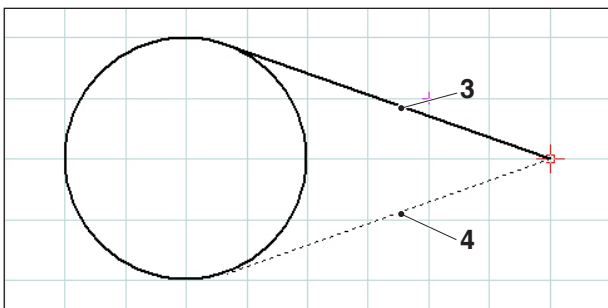

Possible tangents

Tangent (point/circle)

After having chosen the symbol, you have to select the circle element and then define the point across which the tangent shall run. The selected elements change their colour.

Now the two possibilities for selection are displayed. The selected tangent is shown as a full line, the possible tangent as a dashed line. Use the left mouse button to select one possibility.

The two end points of the tangent will be saved as design points.

Item	Description
1	Circle element
2	Point
3	Selected tangent
4	Possible tangent

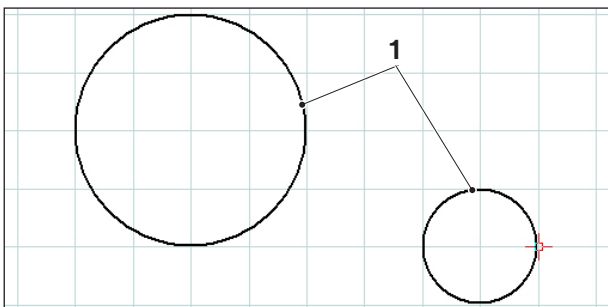

Tangent circle - circle

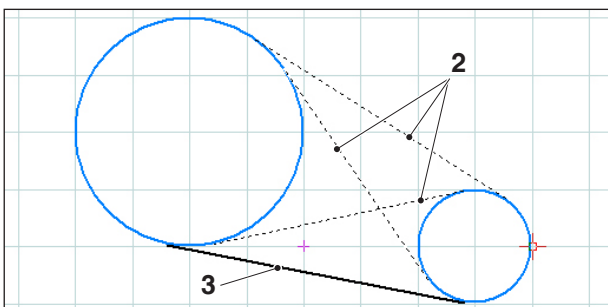

Possible tangents

Tangent (circle/circle)

After having chosen the symbol, you have to select the two circle elements between which the tangent shall be drawn. The selected elements change their colour.

Now four possible tangents are displayed for selection. The selected tangent is shown as a full line, the possible tangents as dashed lines. Use the left mouse button to select a possibility.

The two end points of the tangent will be saved as design points.

Item	Description
1	Circle elements
2	Possible tangents
3	Selected tangent

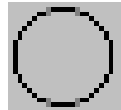

Circle menu



Circle with circle center and radius

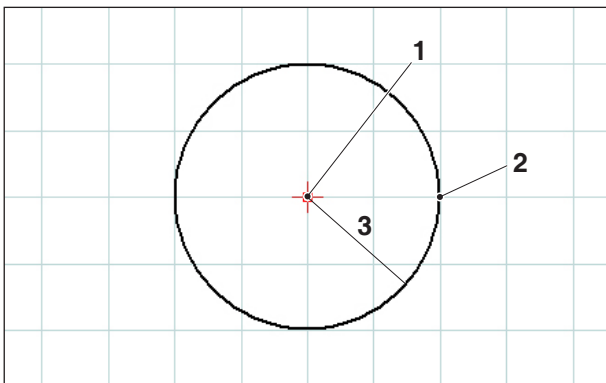

Circle with center and radius

After having selected the symbol, you have to enter the circle center. This can be carried out by one of the following ways:

1. present cursor position and mouse click
2. catch-mode menu (see catch grid and snap points) and mouse click
3. input of coordinates (see coordinate menu)

Then the radius of the required circle has to be entered.

The circle center and the circle point will be saved as design points.

Item	Description
1	Centre of the circle
2	Point on the circumference of the circle
3	Radius

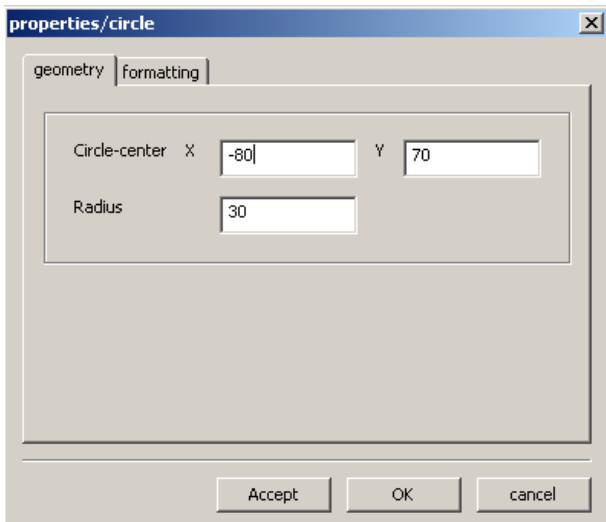

Circle properties window

Circle properties window

Note:

With the key combination CTRL + right-hand mouse button you can call up the properties window (Circle) and retrospectively change the line properties.

In the "Geometry" tab you can

- change the centre of the circle by entering the coordinates
- and change the radius of the circle.

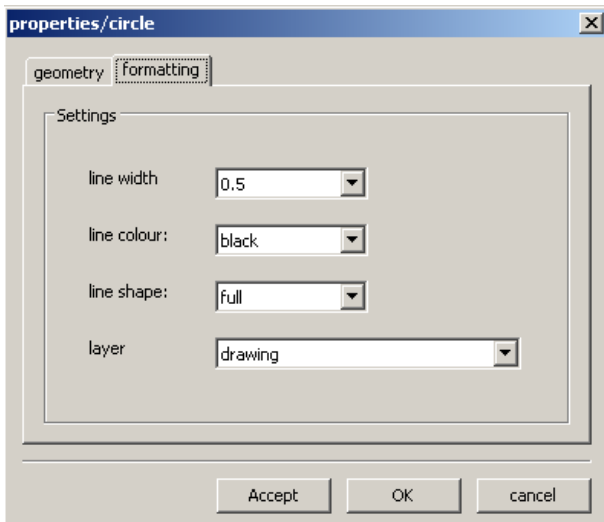

Circle properties window

In the "Formatting" tab you can modify the following properties of the circle:

- Line width
- Line colour
- Line shape
- Layer

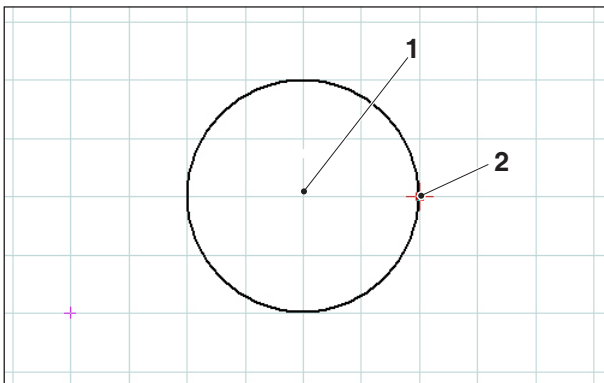

Circle with circle point and center

Circle with centre and point on the circumference

After selecting the symbol the centre of the circle should be entered. This can be done by:

1. pointing the cursor at the desired point and clicking on the mouse
2. using the catch mode menu (see catch grid and catch points) and clicking on the mouse
3. entering the coordinates (refer to the Coordinates menu)

Next the radius of the desired circle should be entered by inputting the coordinates.

The centre of the circle and the point on the circumference of the circle are saved as points of construction.

Item	Description
1	Centre of the circle
2	Point on the circumference of the circle

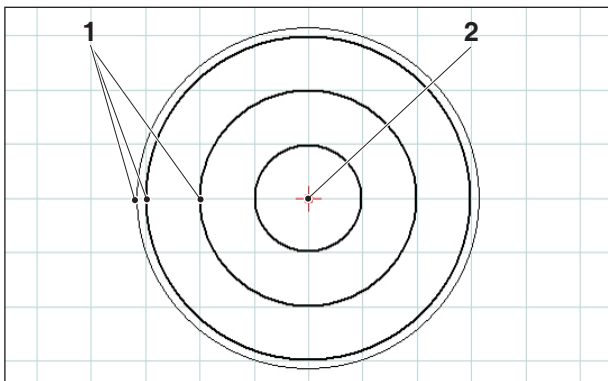

Concentric circles

Concentric circles

After the input of the circle center you have to define a point at the circumference of the required circle. The circle will be immediately drawn by means of the mouse movement. To create additional concentric circles, you only have to enter the circle points.

The circle center and the circle points will be saved as design points.

Item	Description
1	Points on the circumference of the circle
2	Centre of the circle

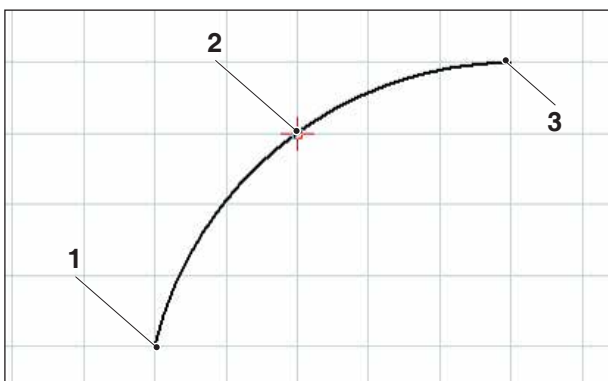

Circular arc with starting, target and circle point

Circular arc with starting point, target point and circle point

After having selected the symbol, you have to define the starting point of the circular arc, then the target point and finally, a point on the circular arc. The circle will be immediately drawn by means of the mouse movement.

The starting point, the target point and the center point will be saved as design points.

Item	Description
1	Starting point
2	Point on the circumference of the circle
3	End point

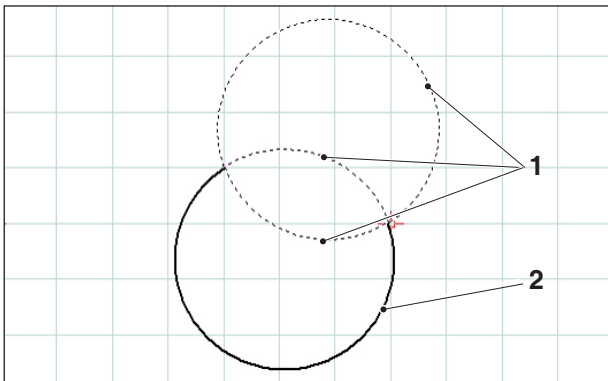

Circular arc with starting point, target point and radius

Circular arc with starting point, target point and radius

After having selected the symbol, you have to define the starting point of the circular arc, then the target point and finally, the radius of the circular arc.

From these inputs result 2 possible circles with 2 possible circular arcs each. The circular arc selected is displayed as a full line, the possible circular arcs as dashed lines. Use the left mouse button to select a possibility.

The starting point, the target point and the center will be saved as design points.

Item	Description
1	Possible arcs
2	Selected arc

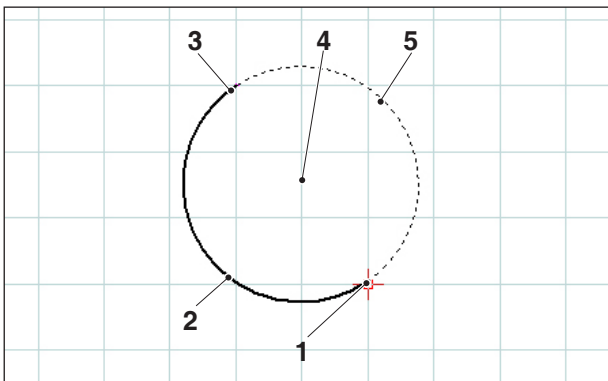

Circular arc with starting point, target point and circle center

Circular arc with starting point, target point and center

After having selected the symbol, you have to enter the starting point of the circular arc, then the target point and finally, the center of the circular arc.

From these inputs result 2 possible circular arcs. The circular arc selected is displayed as a full line, the possible circular arc as a dashed line. Use the left mouse button to choose a possibility.

The starting point, the target point and the center will be saved as design points.

Item	Description
1	Starting point
2	Selected arc
3	End point
4	Centre
5	Possible arc

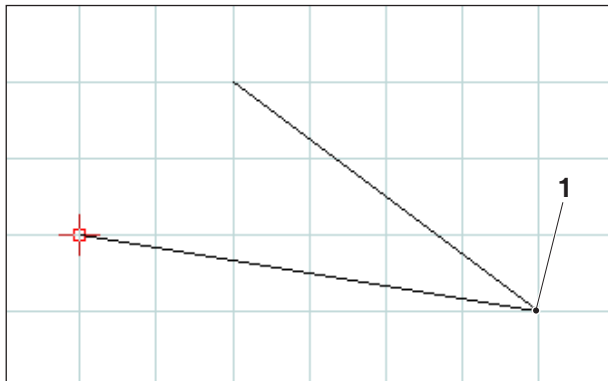

Corner point to be rounded

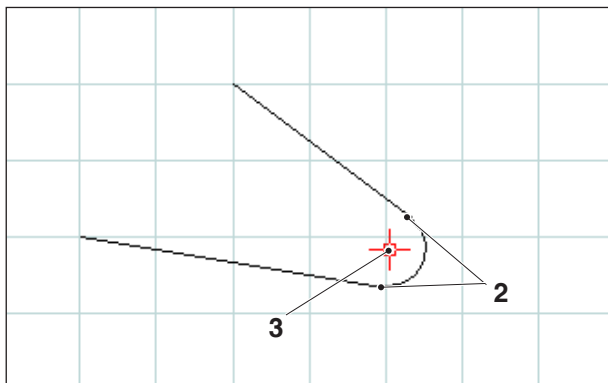

Radius inserted

Insert radius

After having selected the symbol, you have to choose the lines of the corner to be rounded. The selected elements change their colour. Then you have to enter the radius of the chamfer.

The end points and the center of the circular arc will be saved as design points.

Item	Description
1	Corner point to be rounded off
2	Arc end points
3	Arc centre

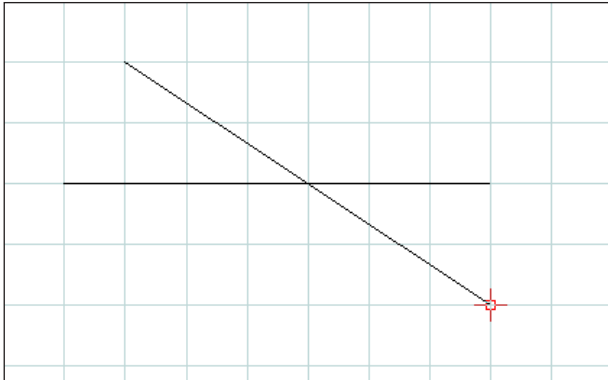

Selection of the elements to be rounded off

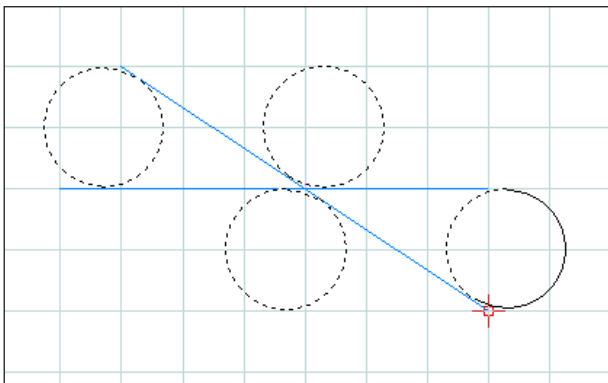

Selection of the possible arcs

Rounded off elements

Example of line-to-line rounding

After selecting the symbol, the elements which are to be rounded off should be selected, and after this the radius of the arc.

This information results in 4 possible circles, each with 2 possible arcs. The selected arc is shown as a continuous line, the possible arcs as dotted lines. Left-click with the mouse to choose one of the options.

The starting point, end point and centre are saved as points of construction.

Item	Description
1	Elements which are to be rounded off
2	Selected arc

Example: Rounding of line and circle

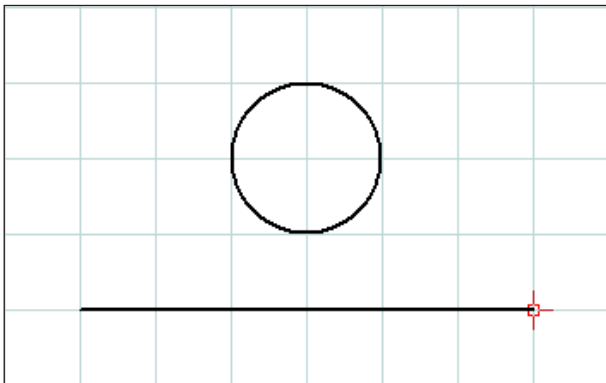

Selection of the elements to be rounded

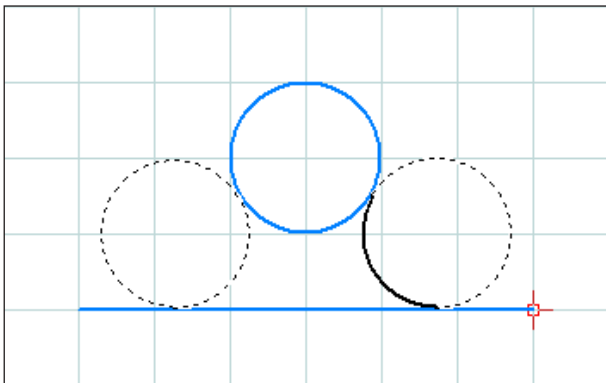

Possible circular arcs

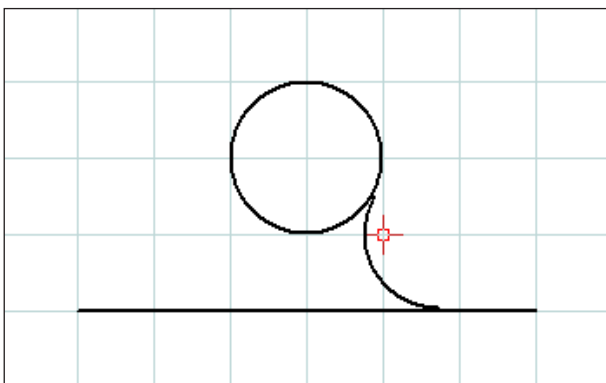

Rounded line and circle

Example: Rounding of circle and circle

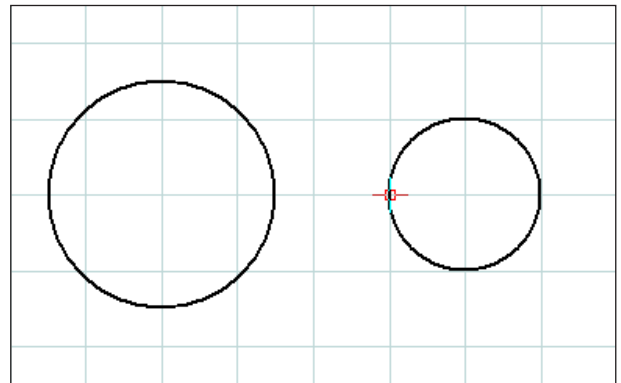

Selection of the elements to be rounded

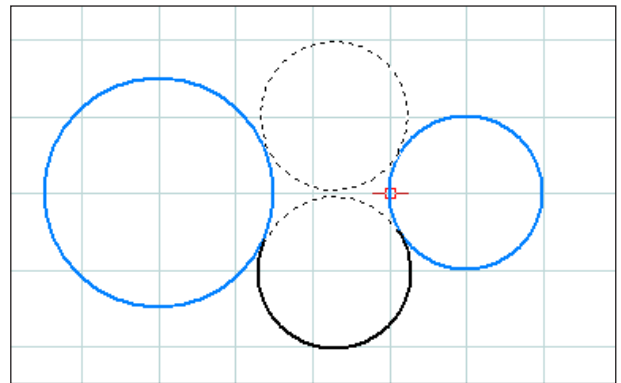

Possible circular arcs

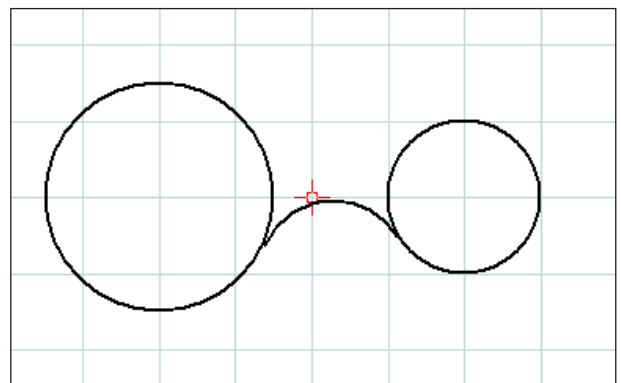

Rounded circle and circle



Selection of the elements to be rounded off

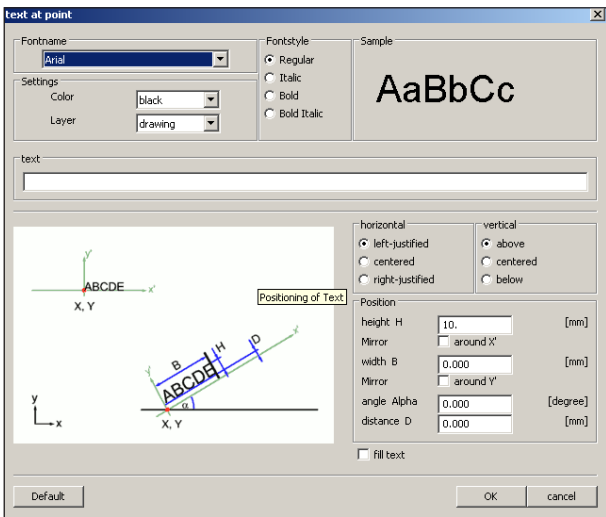

Text input window

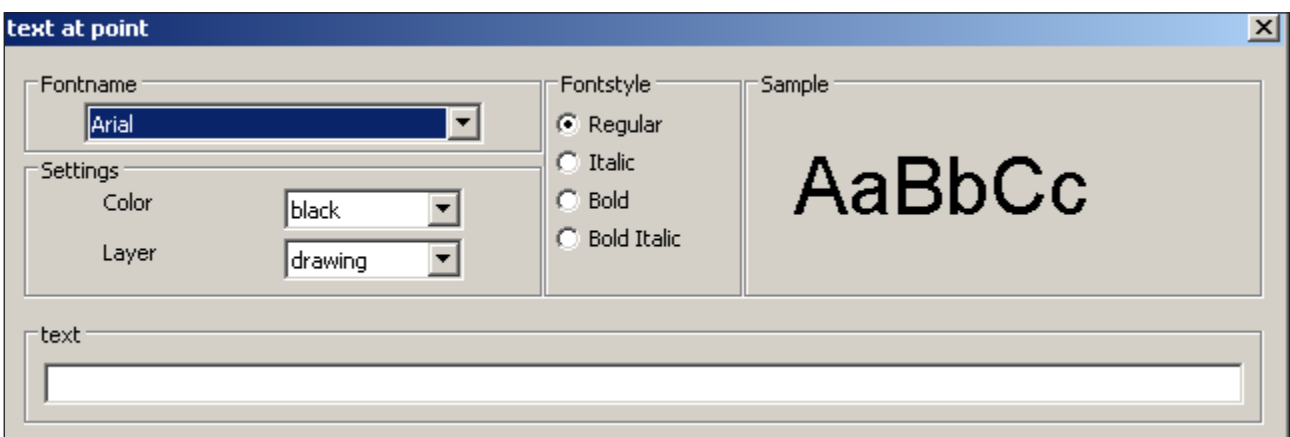

Text input window – font settings

Text menu

After selecting the symbol, 3 symbols appear for creating texts.



Text at point



Text on line



Text on arc

After selecting the required text symbol the text input window appears:

- **Font name:** you can select your preferred font via the dropdown menu. All of the TTF fonts installed in the system are available.
- **Properties:** Select the colour and/or layer of the text you wish to create.
- **Font style:** Here you can change the style of the text you wish to create.
- **Sample text:** This shows a preview of your chosen font settings.
- **Text:** Enter the required text here.



Note:

The fonts defined in the CAD mode can be selected in the text milling cycles in the CAM mode in the "Font" selection field.



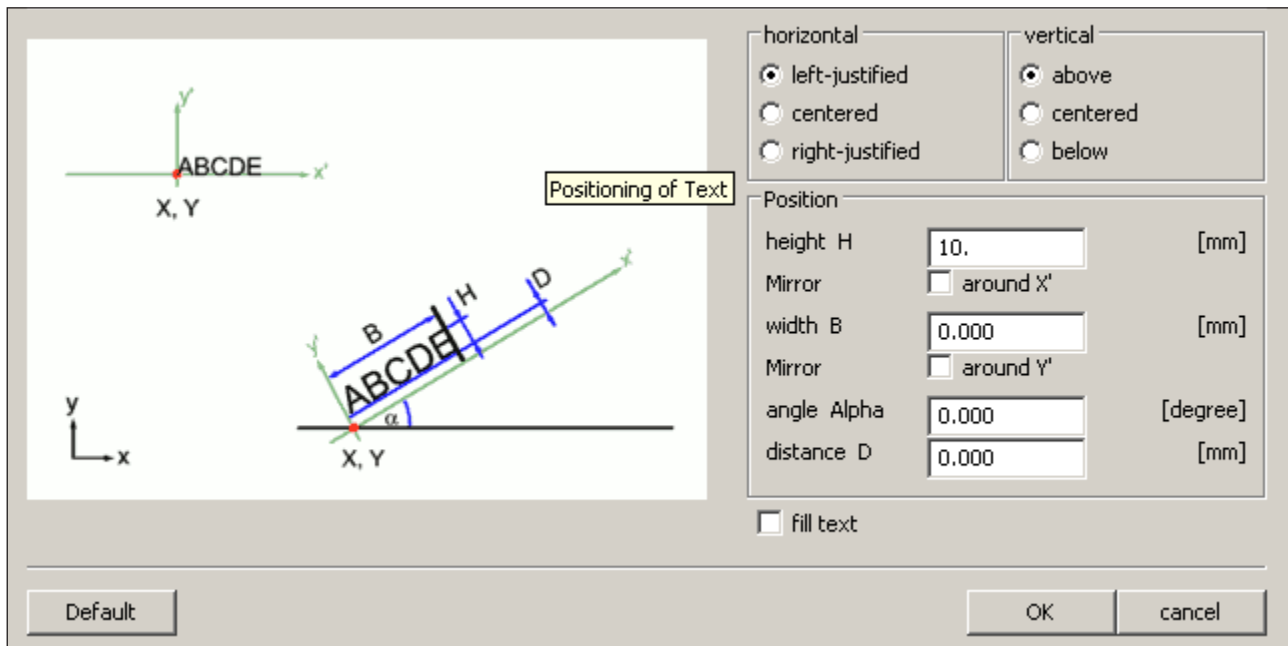

Text input window – adjusting the position of the text

- Horizontal: Here you can select the horizontal alignment of the text you wish to create (left-justified/centred/right-justified).
- Vertical: Here you can select the vertical alignment of the text you wish to create (above/centred/below).
- Fill text: Select this option to display the text filled.

- Position:

Height H / width B: The specified font is scaled to the selected height / width. The default value "0" means that no scaling is applied.

Mirror around X' / Y': When this option is selected the text is mirrored around the X' / Y' axis.

Angle Alpha: Enter an angle for the gradient of the text.

Distance D: Specify a distance D to the reference point (point, line or arc).

OK

Click on "OK" to confirm your selections. Then define the point, line or arc for text positioning.

Default

If you click on the "Default" button the settings you have selected will be discarded and the default settings restored.

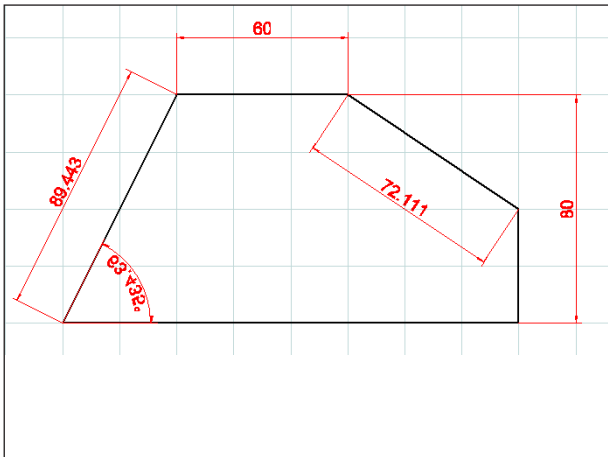
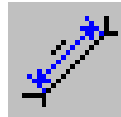

Dimensioning examples

Dimensioning menu

After having selected the symbol, 6 symbols for dimensioning will appear:



horizontal dimensioning



vertical dimensioning



free dimensioning



dimensioning of angles



dimensioning of diameter



dimensioning of radius

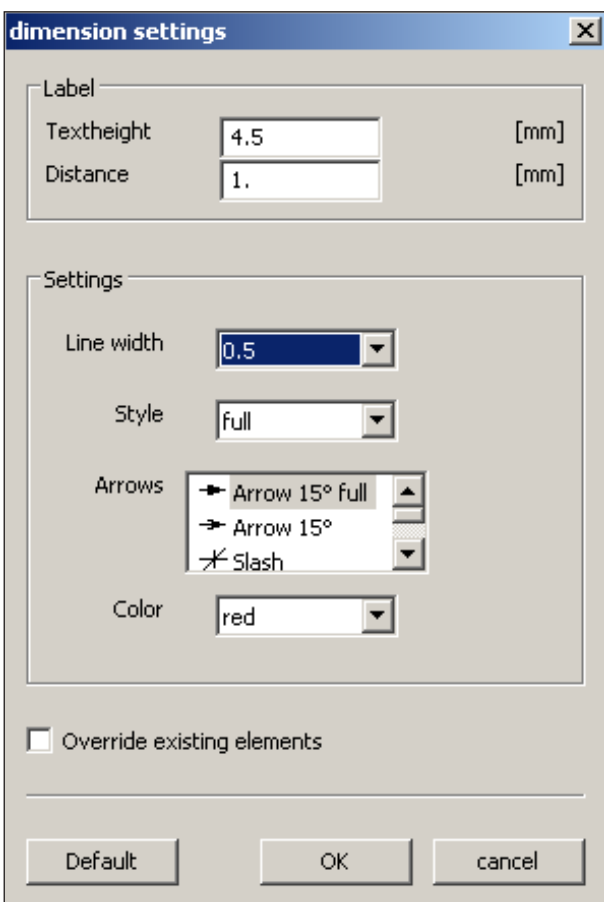

Dimension settings

After having selected the required dimensioning symbol, please define the dimensioning points. You can increase or reduce the distance of the dimensioning to the drawing element by dragging the mouse.



Dimension settings

- **Labelling**
Enter the size of the dimension text. Alternatively, you can also specify the distance between the dimension text and the dimension line.
- **Settings**
Define the line width and style. Choose the required dimension arrows and the colour for the dimension.
- **Override existing elements**
This option is used if you wish to apply the latest settings to existing dimensions.

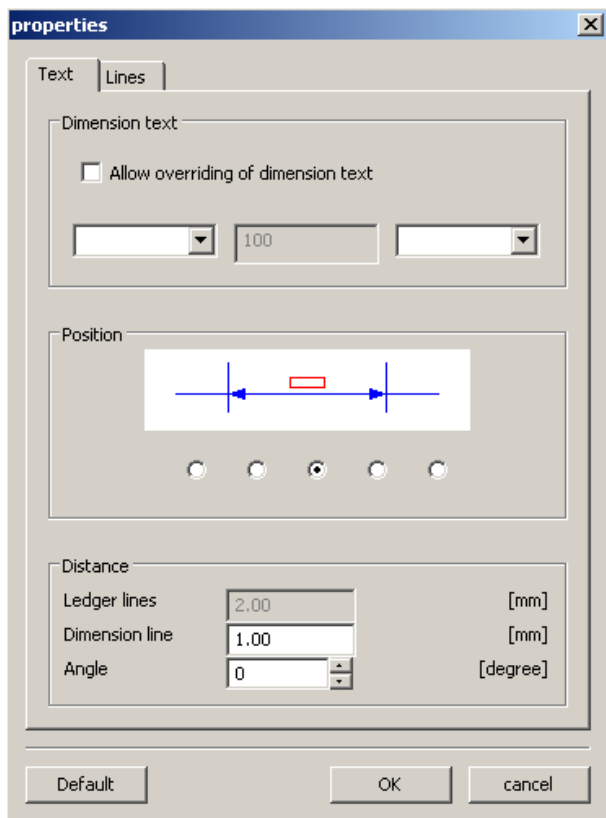

Properties window – text

Properties window – dimensioning

Note:

With the key combination CTRL + right-hand mouse button you can call up the properties window for dimensioning and retrospectively change the dimensioning properties.

In the "Text" tab you can change the following properties:

- Dimension text
You can overwrite the dimension value and specify a text which appears before or after the dimension text.
- Position
You can change the position of the dimension text.
- Distance
You can change the distance to the dimension line or ledger lines and the angle between the dimension text and the dimension line.

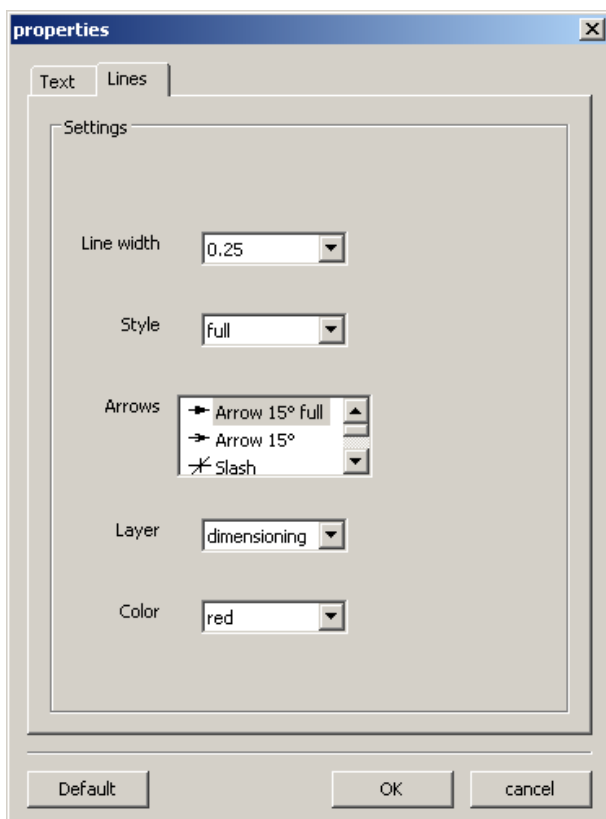

Properties window – text

In the "Lines" tab you can change the following dimension properties:

- Line width
- Line style
- Dimension arrows
- Layer
- Colour

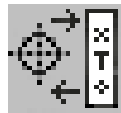

Symbol menu

After having selected the symbol, the window for symbol administration will appear. Symbols serve to reducing the drawing process of already pre-defined and stored drawing objects. These drawing objects are saved as symbols within categories.

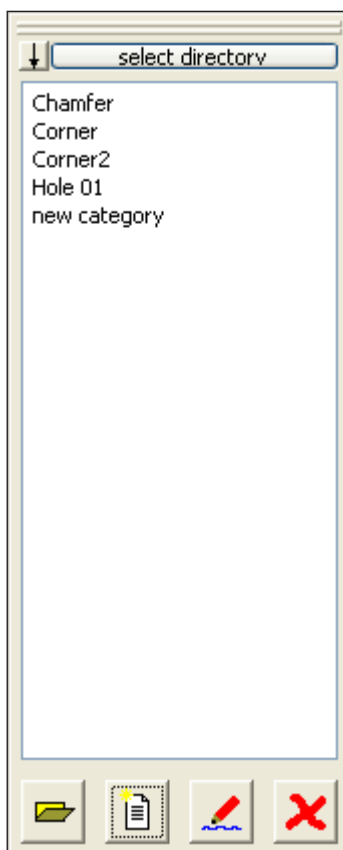

*Symbol administration
Summary of the categories
of the CAMConcept
directory*

Creating categories

Press "Select directory" in order to save new categories in a basic directory that is different from the one proposed by CAMConcept.



These icons can be used to change the sorting order.



Open category

Select the required category and open it by means of the icon or a double click with the left mouse button.



New category

Create a new category. Then rename this "New category".



Rename category

Select the required category and rename the text field by means of the icon or a mouse click.



Delete category

Select the required category and delete it by means of the the icon or the key "Delete".

Creating symbols



Select the required category and open it by means of the icon or a double click with the left mouse button. Now the window of the symbol administration displays all symbols of the respective category with graphic and name.

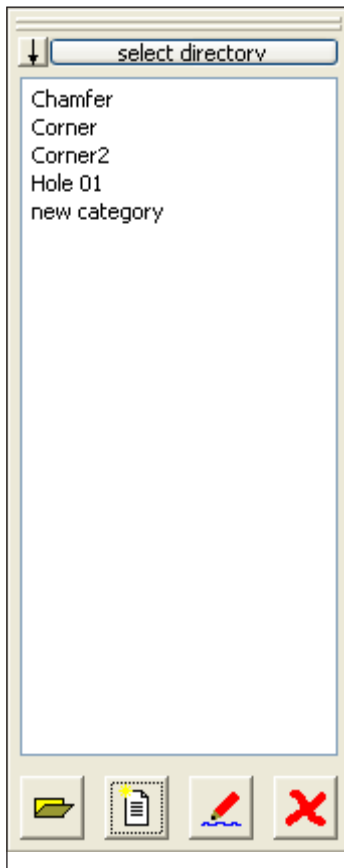

*Symbol administration:
Summary of the symbols of
a category*



These icons enable to display the inputs either with or without graphics.



Insert symbol in drawing

Select the required symbol and drag it into the drawing by means of the icon or the mouse. Move the point of contact to the desired position in the drawing and press the left mouse button.



Create new symbol

After having selected the icon, use the mouse to draw a selection rectangle around the required elements and press the left mouse button. The selected elements change their colour. Select the point of contact where the symbol is orientated when used in the CAD window.



Symbol properties

This icon enables to rename already defined symbols. Select the required symbol and rename the text field by means of the icon or the right mouse button. You can enter the symbol name and additional descriptions.



Delete selected symbol

Select the required symbol and delete it with the icon.

Change menu



Selecting an element

After selecting the icon you can choose one or more in order to subsequently change them; e.g. delete, rotate, shift.

An element can be selected by:

- clicking on the required element.
- dragging the selection rectangle over the required selection range (keep the left-hand mouse button pressed while doing this). This will only include elements which are fully within the selection rectangle.
- When selecting individual elements or dragging the mouse pointer, the element positioned closest to the mouse pointer is highlighted with a different colour in order to indicate the relevant candidate (for selection). The elements which have already been selected are highlighted with another (different) colour.

Ctrl

To make a multiple selection, press and hold the button while selecting elements or areas. You can also deselect an already selected element by selecting it again.



Cutting an element

After having selected the symbol, you have to select the element that should be cut. The selected element changes its colour. Then you have to choose the cutting point.

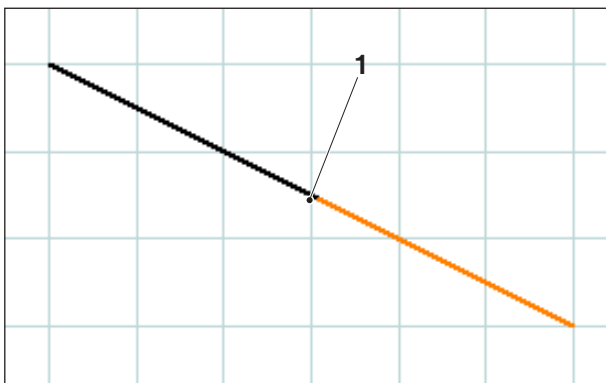

Line cut at the center of the line

Item	Description
1	Line centre



Trimming 1 element

After having selected the symbol, you have to choose the element to be trimmed. Then you have to select the second element. You can either shorten or lengthen elements.

Item	Description
1	Element which is to be trimmed
2	2. Element

Example: Shorten line by means of trimming

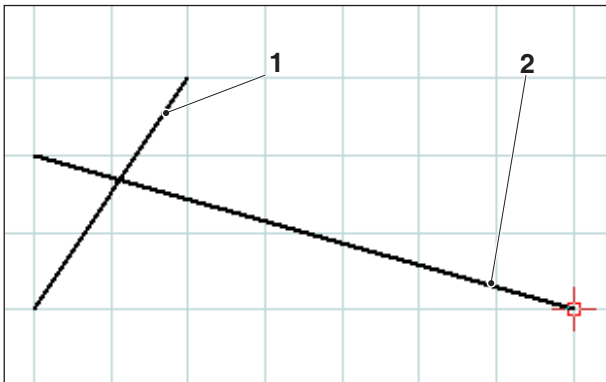

Selection of the line to be shortened

Example: Lengthen line by means of trimming

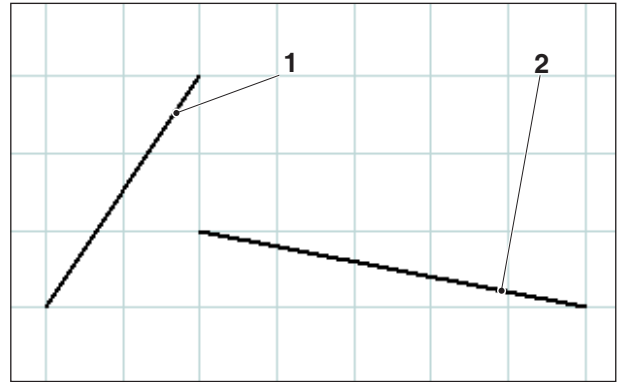

Selection of the line to be lengthened

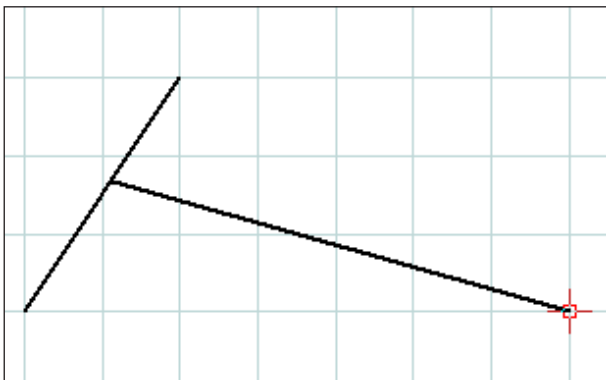

Ready trimmed line

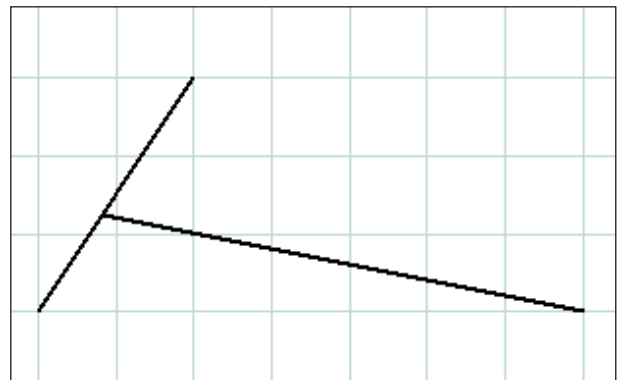

Ready trimmed line



Example: Trim line with circle

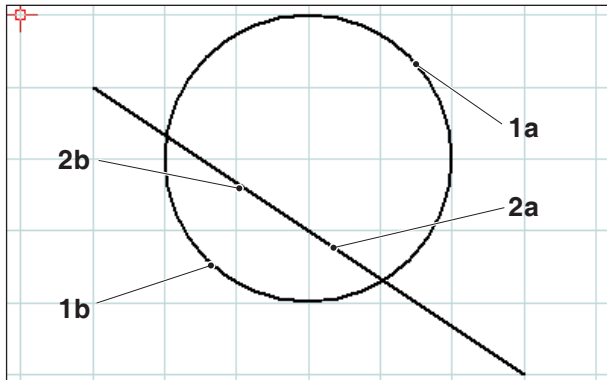

Selection of the elements to be trimmed

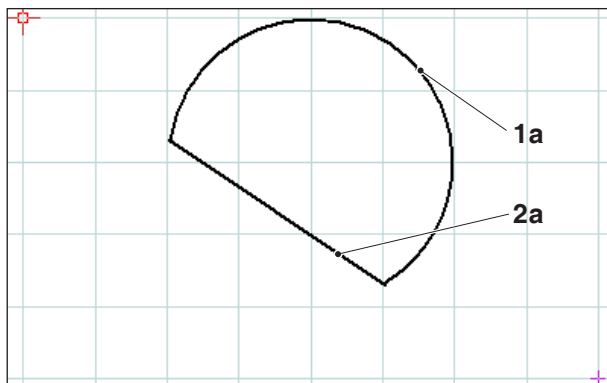

Finished trimmed elements – selection 1a and 2a

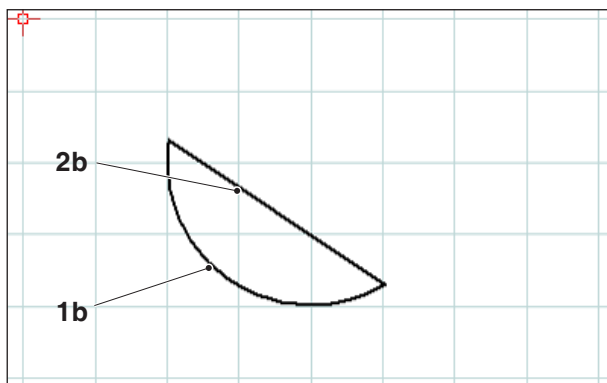

Finished trimmed elements – selection 1b and 2b

Trimming with 2 elements

After clicking on the icon, select the elements you wish to trim. Elements can be shortened or lengthened (refer to the example "Trimming 1 element").

As this function can produce several possible outcomes, such as

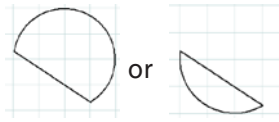

the outcome will depend on the position of the mouse when the first or second element is selected.

Item	Description
1a, 1b	Elements to be trimmed
2a, 2b	Elements to be trimmed
3	Point of intersection
4	New end point = point of intersection

Example: Trim line with line

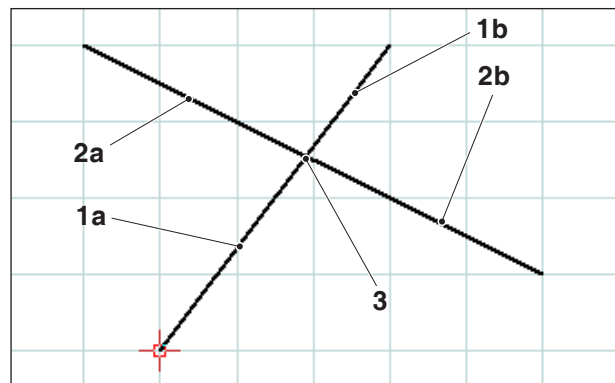

Select of the lines to be trimmed

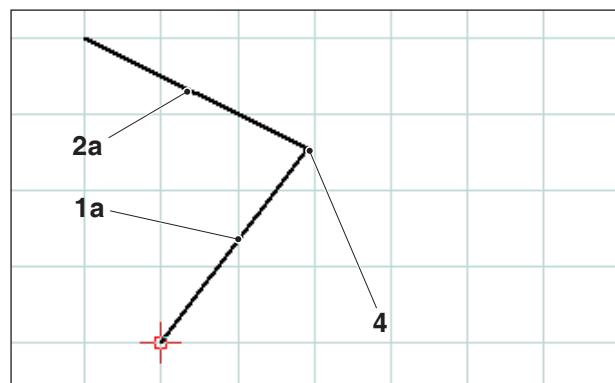

Finished trimmed lines – selection 1a and 2a



Creating hatching

After clicking on the icon, select the outline you wish to fill with hatching. Left-click on the elements to select them. As soon as the outline is closed the enclosed area is filled with hatching.

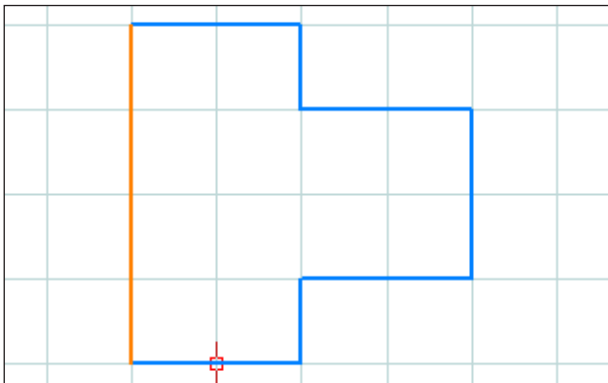

Selection of the outline

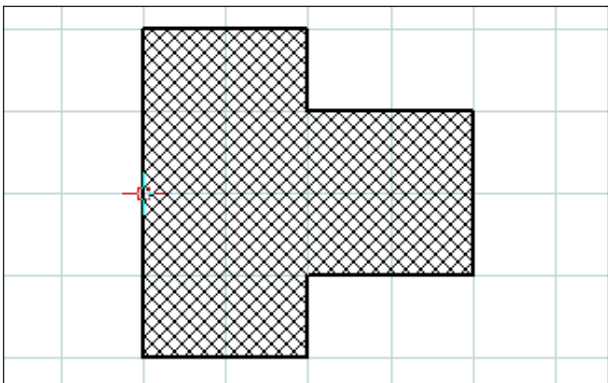

Hatching inside the selected outline

Hatching properties window

Note:

With the key combination CTRL + right-hand mouse button you can call up the properties window for dimensioning and retrospectively change the dimensioning properties.



In the "Hatching type" tab you can choose your preferred type of hatching. The "Formatting" tab allows you to change the colour of the hatching.

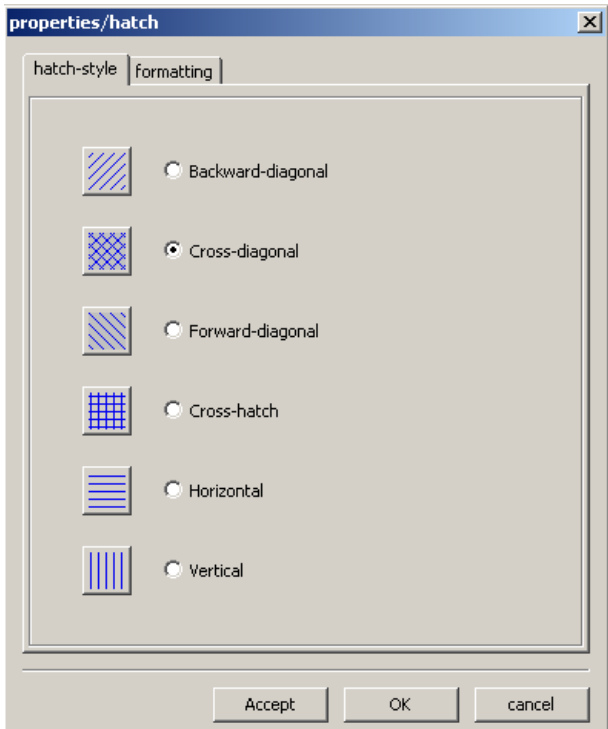

Properties window – hatching

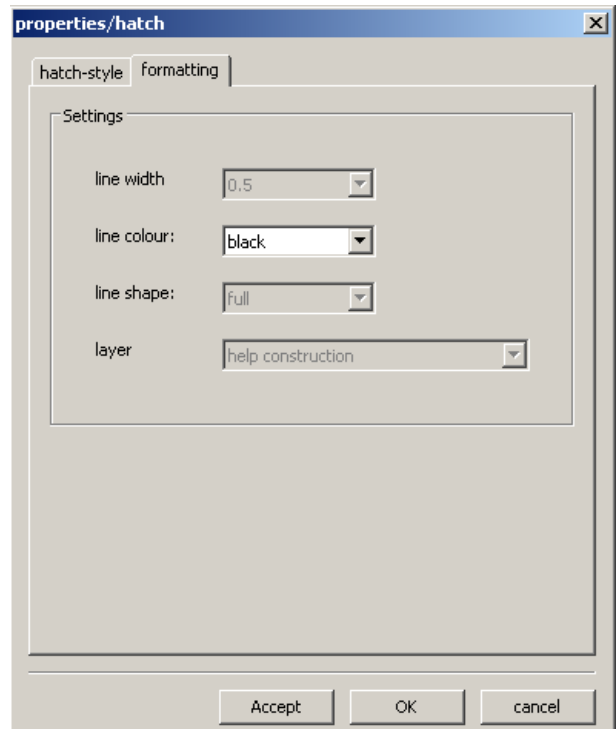

Properties window – hatching

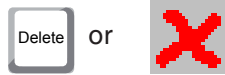

Delete

After selecting the elements you wish to delete, click on the "Delete" icon.

The selected elements are deleted when you click on the icon.



Shifting an element absolutely or incrementally

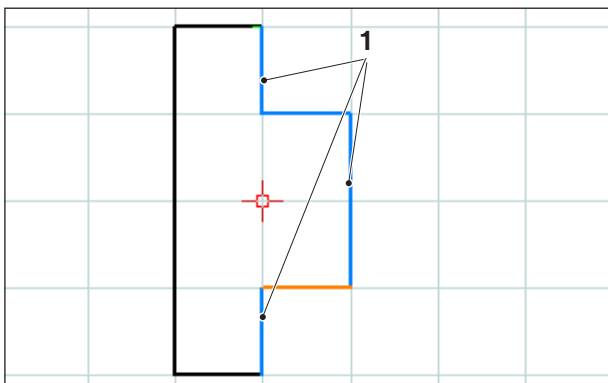

Selection of the elements

After selecting the elements you wish to shift, you can click on the icon for "Shifting an element absolutely or incrementally".

After clicking on the icon you can input the following:

- In the input field for the axes, enter the incremental shift.

or

- Using the left-hand mouse button, select a reference point and an end point for the absolute shift.

The shift relates to the position of the selected elements.

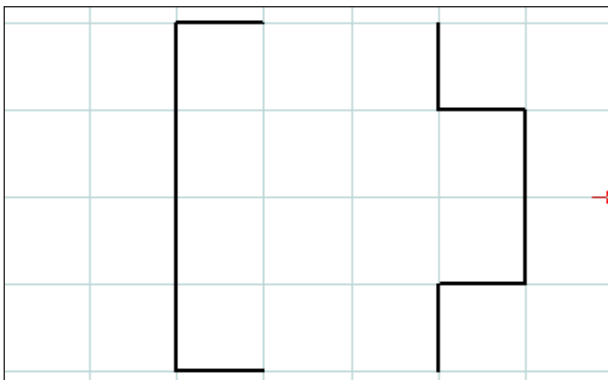

Selection of the elements

Item	Description
1	Selected elements



Shifting and copying an element absolutely or incrementally

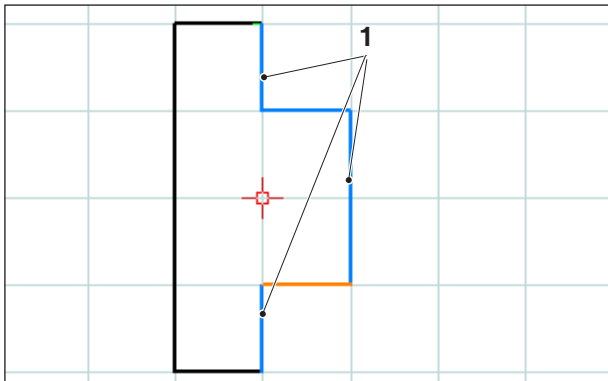

Selection of the elements

After selecting the elements you wish to shift, you can click on the icon for "Shifting and copying an element absolutely or incrementally".

After clicking on the icon you can input the following:

- Input the incremental shift in the input field for the axes.

or

- Left-click with the mouse on a reference point and select an end point for the absolute shift.

The shift relates to the position of the selected elements.

Afterwards enter the required number of copies in the input field.

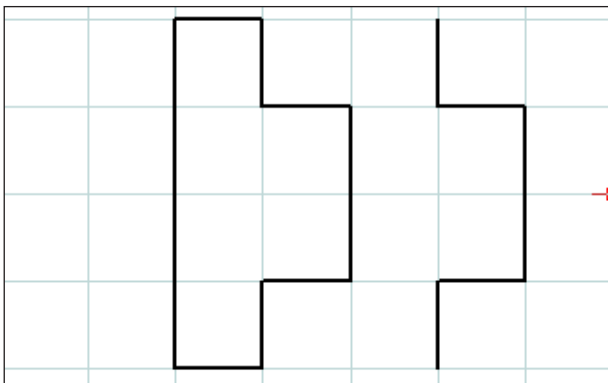

Shifted and copied elements (1 copy)

Item	Description
1	Selected elements

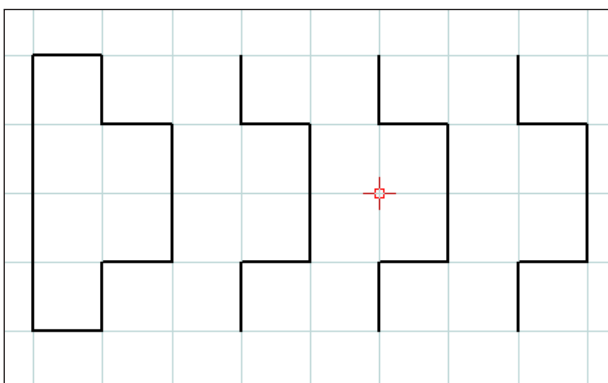

Shifted and copied elements (3 copies)



Rotate

After selecting the elements you wish to rotate you can click on the "Rotate" icon.

After clicking on the symbol, select the point of rotation by entering its coordinates in the input field or by left-clicking with the mouse. The point of rotation is the point around which the elements are rotated.

Enter the angle of rotation in the input field. A positive or negative value can be entered for the angle of rotation.

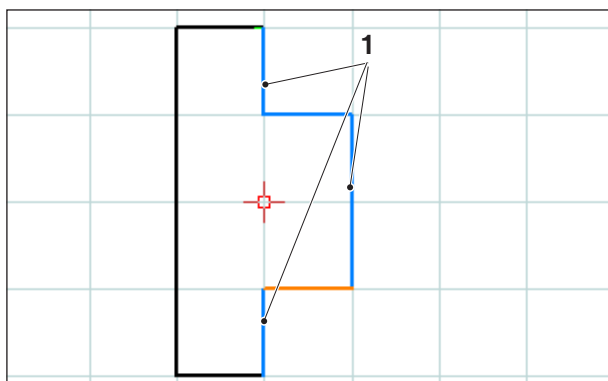

Selection of the elements

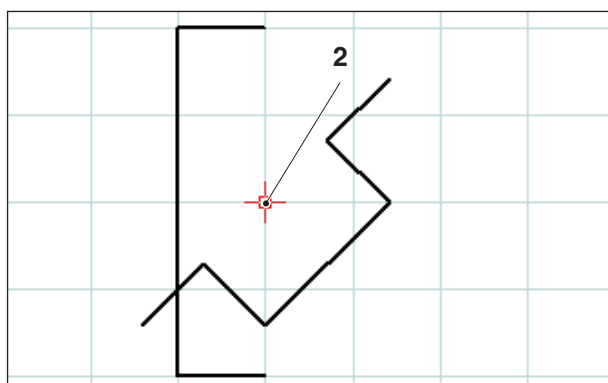

Rotated elements (-45°)

Item	Description
1	Selected elements
2	Point of rotation



Rotating and copying

After selecting the elements you wish to rotate you can click on the "Rotate and copy" icon.

After clicking on the symbol, select the point of rotation by entering its coordinates in the input field or by left-clicking with the mouse. The point of rotation is the point around which the elements are rotated.

Enter the angle of rotation in the input field. A positive or negative value can be entered for the angle of rotation. With multiple copies, the angle always relates to the position of the previous copy.

Enter the required number of copies in the input field.

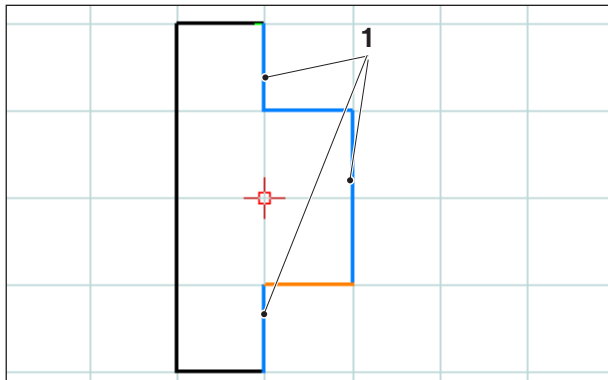

Selection of the elements

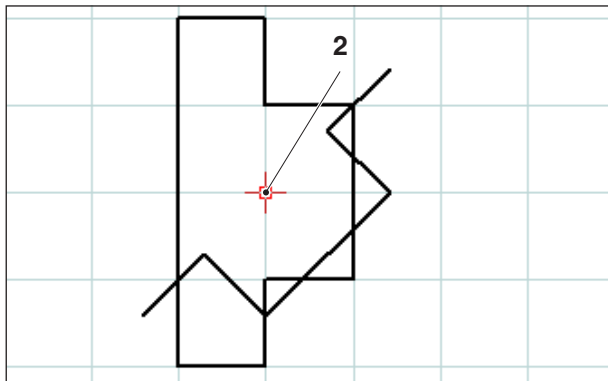

Rotated and copied elements (-45°; 1 copy)

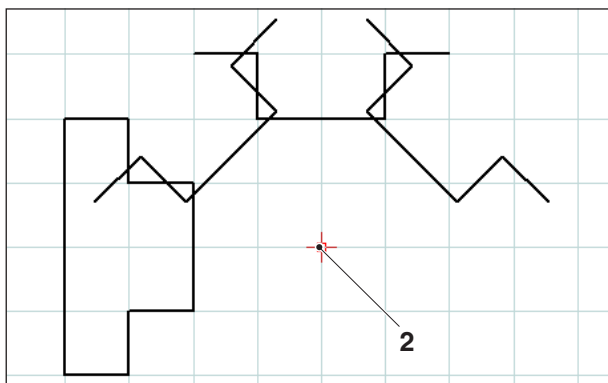

Rotated and copied elements (-45°; 3 copies)

Item	Description
1	Selected elements
2	Point of rotation



Mirroring

After selecting the elements you wish to mirror you can click on the "Mirroring" icon.

Once you have clicked on the icon you can define the mirror axis. The mirroring is defined by the first and second points entered for the mirror axis. By entering these points you can freely define mirror axes as required.

Select the first and second point of the mirror axis by entering the coordinates or by left-clicking with the mouse.

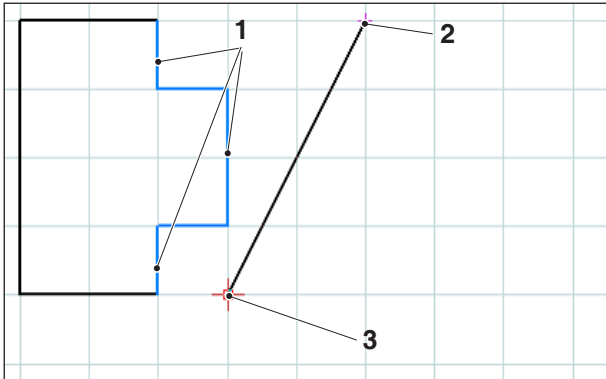

Selection of the elements; mirror axis

Item	Description
1	Selected elements
2	1. point on the mirror axis
3	2. point on the mirror axis

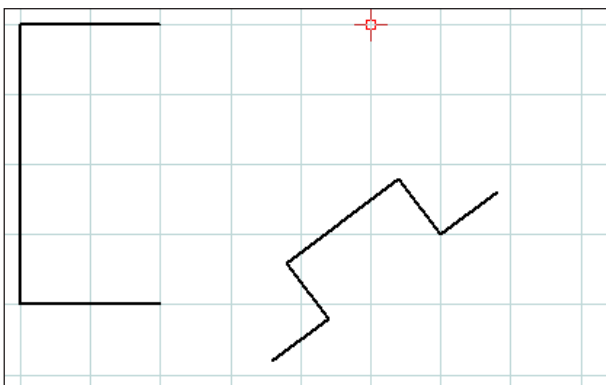

Mirrored elements



Mirroring and copying

After selecting the elements you wish to mirror you can click on the "Mirroring and copying" icon.

Once you have clicked on the icon you can define the mirror axis. The mirroring is defined by the first and second points entered for the mirror axis. By entering these points you can freely define mirror axes as required.

Select the first and second point of the mirror axis by entering the coordinates or by left-clicking with the mouse.

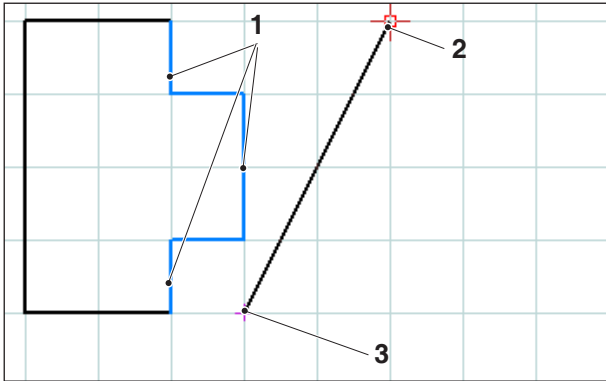

Selection of the elements; mirror axis

Item	Description
1	Selected elements
2	1. point on the mirror axis
3	2. point on the mirror axis
4	Selected elements
5	Mirrored and copied elements

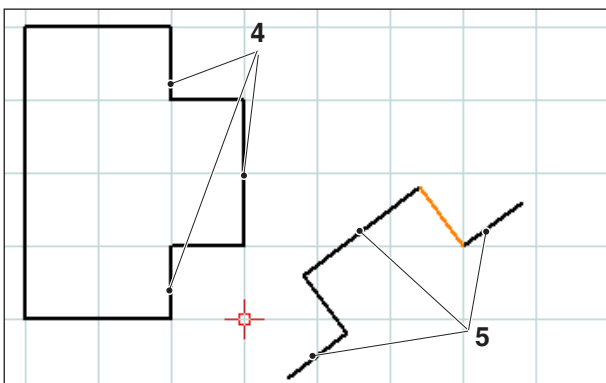

Mirrored and copied elements



Scaling

Scaling means that elements are reduced or magnified.

After selecting the elements you wish to scale you can click on the "Scaling" icon.

Scaling is defined by entering a scaling point and the scaling factor. The scaling point is the centre of the scaling.

Select the scaling point and the scaling factor in the input field.

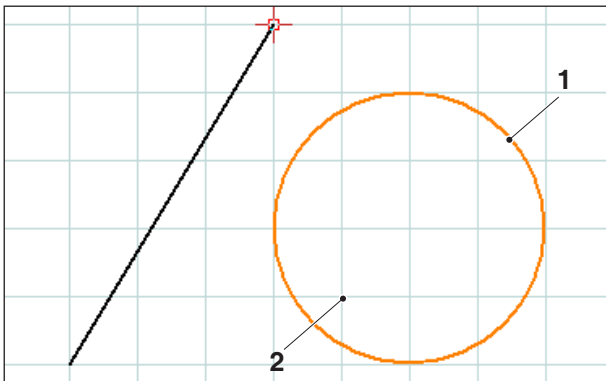

Selection of elements; scaling point

Item	Description
1	Selected element
2	Scaling point

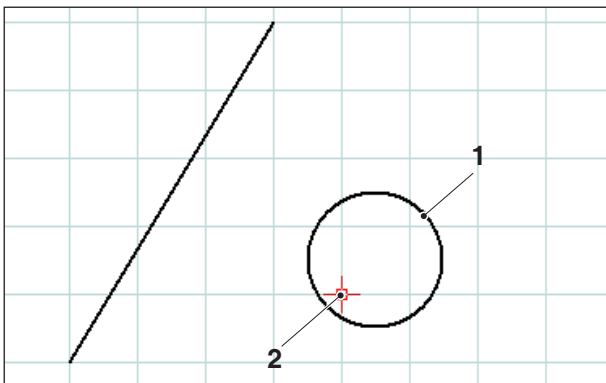

Scaled element; here: scaling factor = 0.5

E: CAM commands



CAM mode

The CAM command symbols are activated by clicking on the shift symbol "CAM". The CAM mode will remain active until it is deactivated again by means of CAD, NC or AV (operations scheduling).

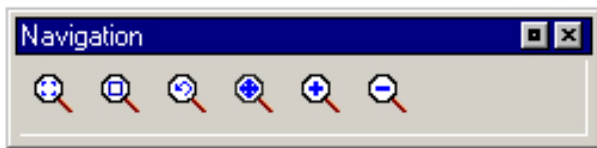

The zoom commands are explained in chapter B.



Restructuring

After pressing the F5 key the screen is restructured again.

After delete and modifying functions it may happen that lines are not completely displayed on the screen. In this case use the function "Restructure" or the zoom commands to get a new display of the screen.



Generating



Settings

The settings serve to defining the machine type. Tools can be entered from an extensive tool database into tool tables. Measurements of unmachined parts are defined by means of an input graphic.

HiNote:

Additional new tools for the tool database can be created easily and quickly by means of the "3D ToolGenerator".



Machine

After having selected the symbol, you can choose the machine type (only at programming places) and the corresponding tool tables. The tool tables are saved in the respective project file (*.ecc). The active tool table can be saved under a freely selectable name at any time, so as to be available for other projects as well.

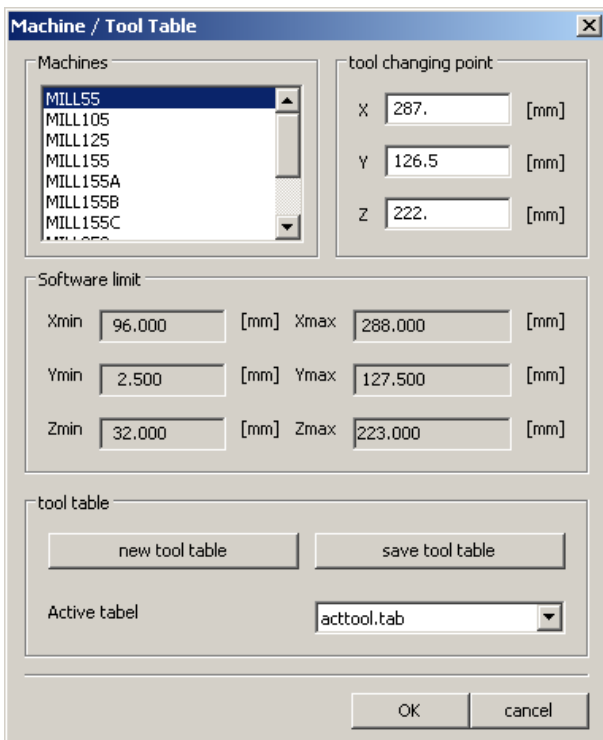



Tool table

Tool measurement

After having selected the symbol, the CAMConcept window "Tool measurement" will appear. Now you can edit the tool system of the NC machine:

tool measurement

tool name

X 286.236 F 0.00
 Y 113.000 S 0
 Z 212.150 T 0 D 1

T 1 D 1

Z 0.000

acttool.tab >>

T.D	TOOLNAME
1.1	Spiralbohrer 5mm
2.1	Scheibenfräser 35mm

[END]

tool offsets

R 2.500 L 0.000
 I 0.000 K 0.000

Insert edge F1 Reset tool F2 Change name F3 Tool database F4 Geometry F5 Technology F6 Back F8

Enter new tool place.

- Delete existing tool = tool reset.
- Rename existing tool.
- Measure tool on device.
- Enter tool or new blade in tool chart.
- Delete tool place = delete tool.

tool measurement

X -110.000 F 0.00
 Y 10.000 S 0
 Z 55.000 T 0 D 1

T D

toolmill.tab

T.D	TOOLNAME
10.1	Langlochfräser 8mm
11.1	Spiralbohrer 20mm
12.1	Langlochfräser 5mm
13.1	Langlochfräser 4mm
14.1	Langlochfräser 1mm
14.2	Langlochfräser 1mm
15.1	

[END]

Insert tool Tool database Back

Enter new tool place

- Move the cursor to [END].
- Press the softkey "Insert tool F1".
- Define all tool geometry and tool technology data.

Move cursor to [END].

tool measurement

X -110.000 F 0.00
 Y 10.000 S 0
 Z 55.000 T 0 D 1

T 2 D 2

Z 0.000

toolmill.tab >>

T.D	TOOLNAME
1.1	Langlochfräser 10mm
2.1	Spiralbohrer 8mm
2.2	Spiralbohrer 8mm
3.1	Gewindebohrer M8
4.1	Spiralbohrer 5mm
5.1	Walzenstirnfräser 40mm
6.1	Gewindefräser 8mm
7.1	Reibahle 8H7

tool offsets

R 4.000 L 55.000
 I 0.000 K 0.000

Insert edge Delete tool Change name Tool database Geometry Technology Back

Enter a new place for additional tool blade

- Move the cursor to the tool number to which an additional tool blade shall be entered.
- Press the softkey "Insert edge F1". A additional tool blade will be added to the existing tool number.

Enter additional tool blade.

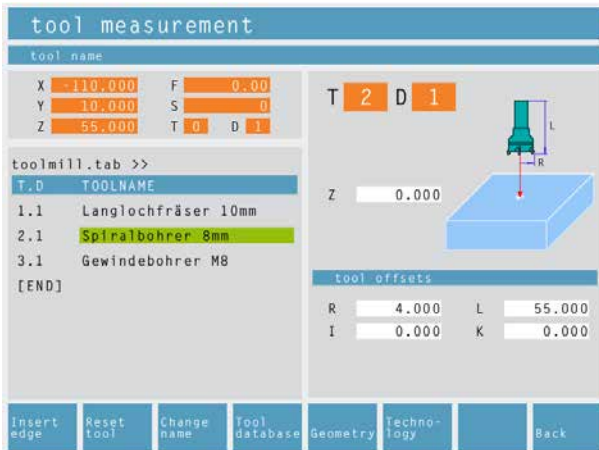

Delete existing tool.

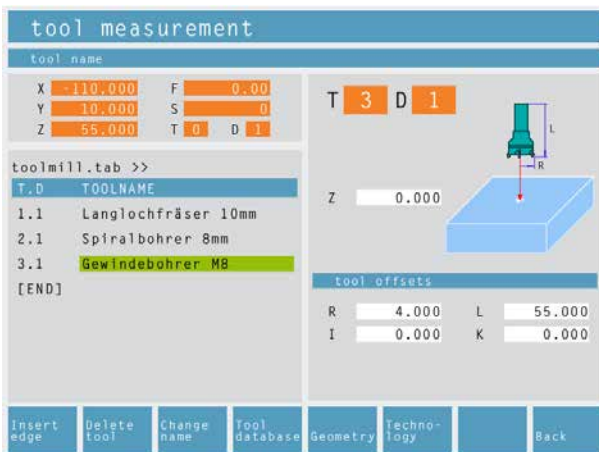

Delete tool place.

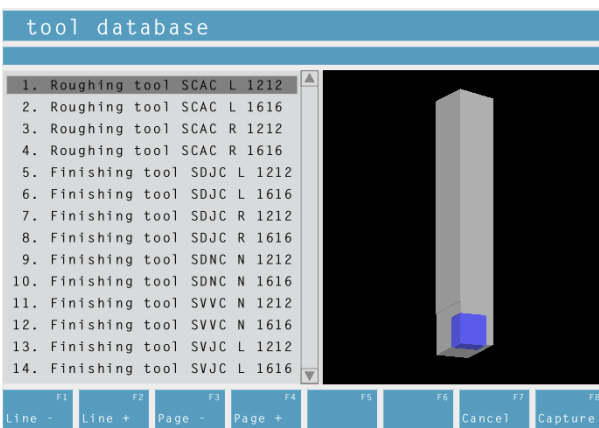

Tool database

Delete existing tool

- Move the cursor to the tool to be deleted.
- Press the softkey "Reset tool F2". The tool place will be emptied, but preserved.

Delete tool place

- Move the cursor to the tool with the highest T number (last tool on the list).
- Press the softkey "Delete tool F2". The whole tool place will be deleted.

Entering a tool from the tool database into the tool table

- Press the soft key "Tool database F4".
- Move the cursor keys to the tool you wish to capture.
- Press the soft key "Capture F8".
- The required tool will be entered into the tool table at the chosen position. A previous tool, if existing, will be replaced by the new one.

Geometry

Defining tool data

- Fasten a workpiece of known height in the toolholder.
- Press the soft key "Change tool F3".
- Define the following parameters:
 - workpiece height Z
 - R...tool radius
 - I...wear tool radius
 - L...tool length
 - K...wear tool length

Technology

The standard values of the machine for the feed and for the spindle speed can be further limited by means of the soft key "Technology F6". After selection of the tool the respective spindle speeds and feeds will be already entered in the cycles as changeable proposal.

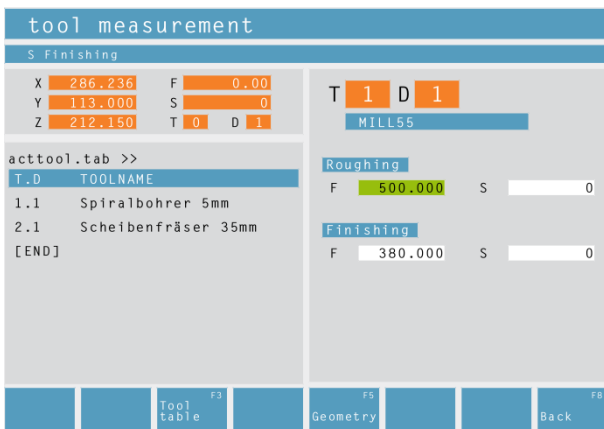

Technology data for tools

Saving the tool data

A freely chosen workpiece (reference part) is used to measure the tools. The surface of the workpiece is defined as the measuring plane. The tools which are to be measured scratch on the measuring plane one after the other. The Z-value at the time of scratching (in relation to the tool) is defined with the value Z=0.

Purpose: If a previously measured tool (tool with tool holder) runs to Z=0 after re-clamping, the tool is exactly in the measuring plane defined by the user.

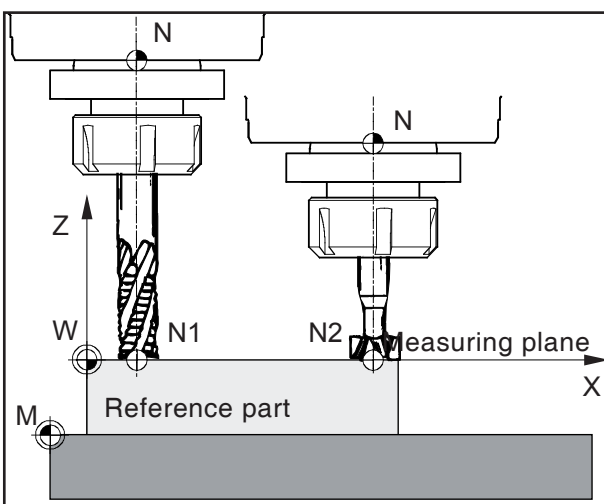

Tool insert

Name change

Geometry

tool measurement

Z coordinate of the calibration part

X	286.236	F	0.00
Y	113.000	S	0
Z	212.150	T	0
		D	1

T 1 D 1

Z 0.000

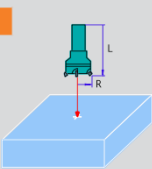

acttool.tab >>

T.D	TOOLNAME
1.1	Spiralbohrer 5mm
2.1	Scheibenfräser 35mm

[END]

tool offsets

R	2.500	L	0.000
I	0.000	K	0.000

Get L-value F2 Tool table F3 Technology F6 Back F8

Tool measurement with scratching method

- Press the softkey or retrieve from the tool database
- Enter the tool name or retrieve it from the tool database.
- Define the Z-value of the reference part as "0" (Z-coordinate in relation to the X-Y plane (measuring plane)).
- Enter the tool radius (R).
- Scratch the reference part (workpiece) in the Z-axis.

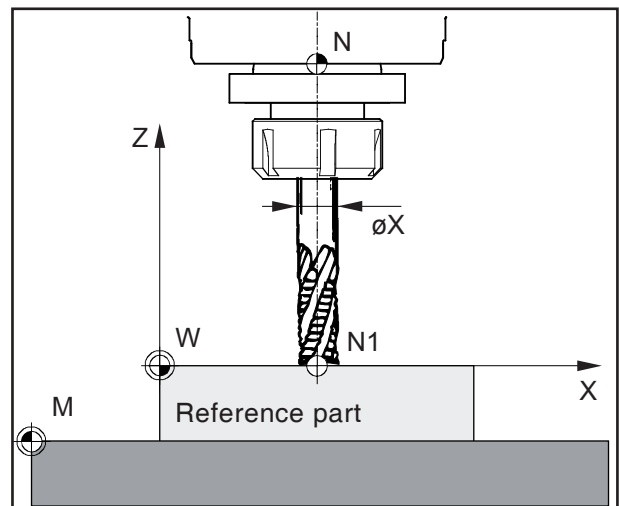

Scratching in the Z-axis

Transfer L

Note:
 The data L and R indicate the dimensions of the tool. The data I, K indicate the correction factor which has to be taken into account by the control system in order to compensate for tool wear.
 The control system adds the value of the correction factor (K) to the length (L) and the correction factor (I) to the radius (R) in order to obtain the actual tool length (L+K) and tool radius (R+I) it needs to use.

- Press the softkey. The control system will automatically calculate the tool length (L).
- Tool 1 has now been measured in longitudinal direction. The control system sets the values for I and K to 0. The values are saved in the tools table under the relevant tool number.
- Define the tool technology data as required for the relevant tool types.

Variants of the tool measurement method with scratching:

The measuring plane ($Z=0$) can also be defined at any other position in the working space.

Example 1:

The reference part (workpiece) has a precisely defined height (e.g.: 20mm).

If, when the tool is measured with the scratching method, the Z-value of the reference part is defined as "20" instead of "0", the position $Z=0$ is on the machine table.

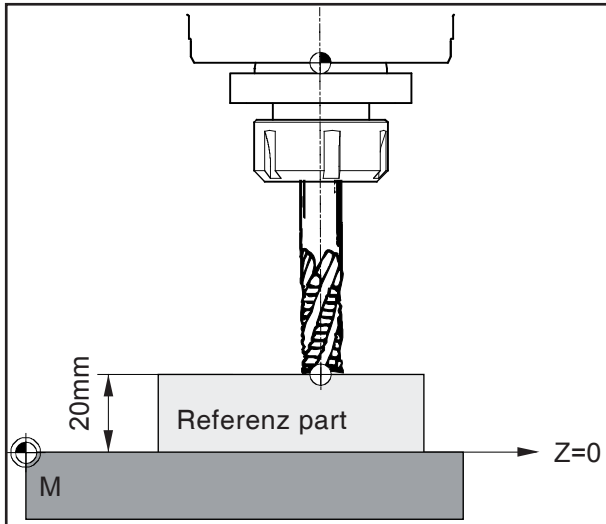

Example 2:

The reference part (workpiece) is an unmachined workpiece with an oversize of 2mm.

If, when the tool is measured with the scratching method, the Z-value of the reference part is saved as "2", the position $Z=0$ will lie on the surface of the workpiece once it has been machined and finished.

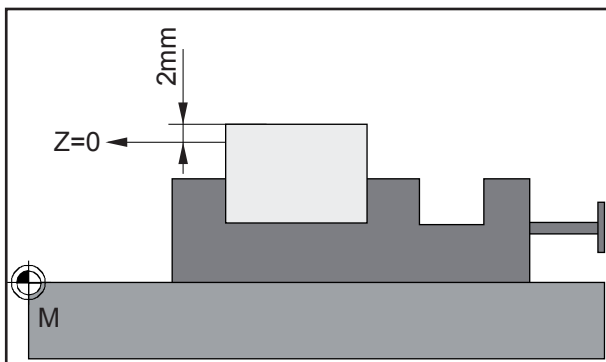

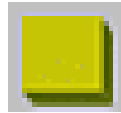

Unmachined part

After selecting the icon you can define the dimensions of the unmachined part and the position of the clamping device in the "Block" tab.

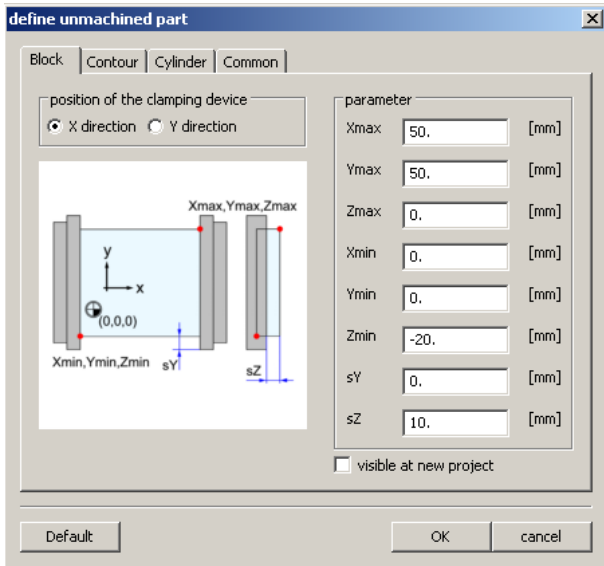

The "Contour" tab allows you to assign a predefined contour to the unmachined part.

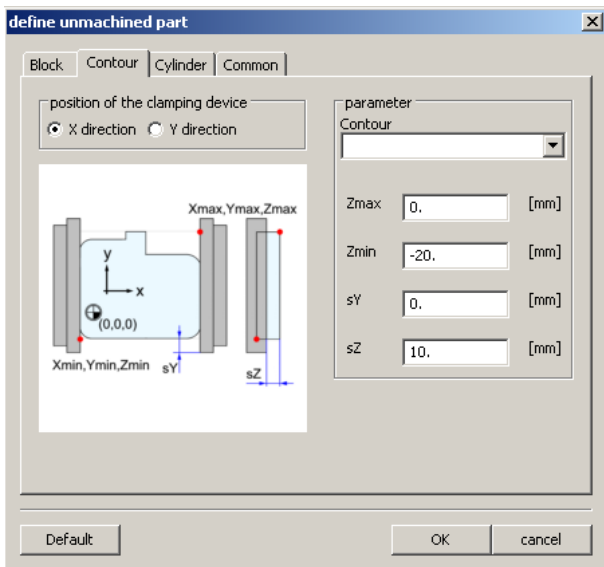

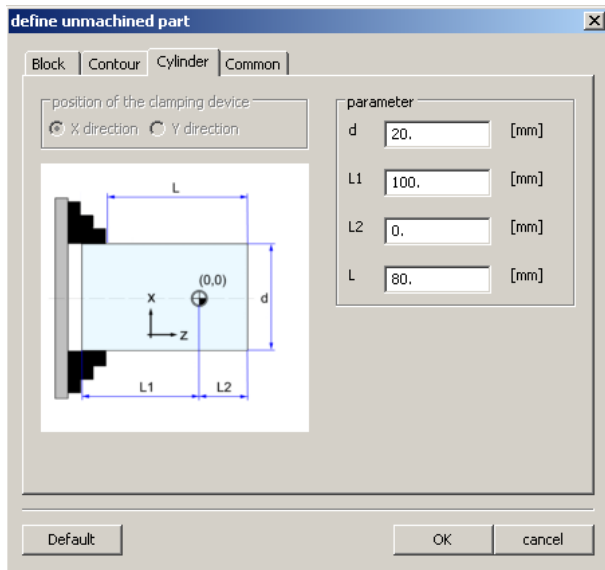

The "Cylinder" tab allows you to define an unmachined part with a cylindrical form.

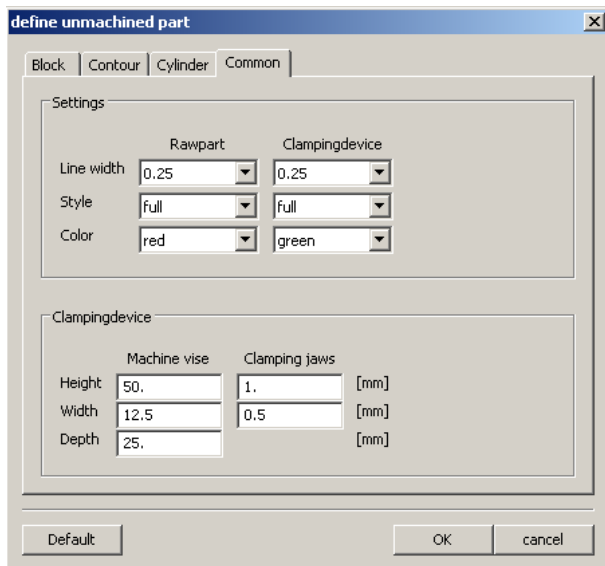

In the "General" tab you can specify the line width, line style and colour of the unmachined part.

In addition, you can also define the dimensions of the clamping device for the 2D simulation.

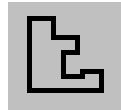

Entering a contour

When selecting working cycles, the definition of a contour to be machined is expected. A contour must be defined before.

Defined contours are filed in the window "Working steps". The saved contours can be renamed or deleted.



Contour tracking – segments

For geometries having a complex structure it may be easier to define the contour by selecting single segments of an element (e.g. many intersection points).

After having selected the symbol, you can use the mouse to define drawing elements and segments of elements as contour. In case CAMConcepts offers several possibilities (e.g. intersection points), choose the further course of the contour by mouse click.

The selected elements and segments change their colour.

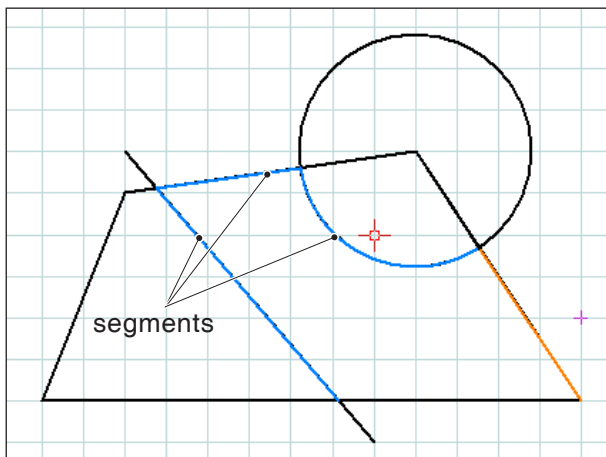

Connection of single segments



Contour tracking – elements

CAMConcept is able to recognize coherent drawing geometries (elements with the same starting or end point) and consequently a contour. This makes the contour definition very easy.

After having selected the symbol, you can define coherent drawing elements as contour by means of the mouse. CAMConcepts starts connecting elements until there are various possibilities (e.g. branches) to choose from. Select the further course of the contour by mouse click.

The selected coherent elements change their colour.

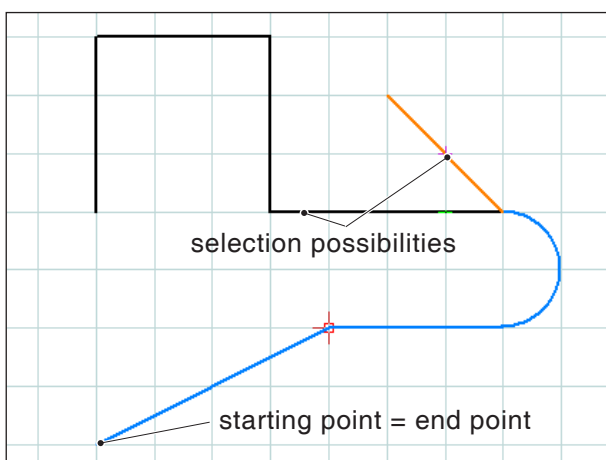

Connection of elements with the same starting or end point



Contour tracking – text

After having selected the symbol, you can use the mouse to define the characters of a text as contour. Outside and inside contours must be defined individually as contour.

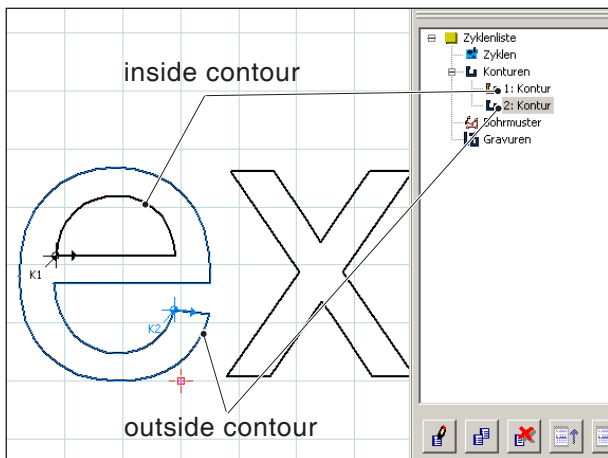

Connecting characters of a text



Save contour

CAMConcept recognizes coherent contours and automatically saves them in the window "Working steps".

After selection by means of the mouse, this symbol enables to define contours that have not been recognized automatically.



Cancel contour

With this symbol you can cancel already selected elements (elements with changed colour). The contour will not be saved.



Note:

You can cancel one element each of already selected elements (elements with changed colour) by means of the right mouse button. The contour can always be saved.



Define new starting point

You can define a new starting point of a contour only when a contour has already been defined before.

CAMConcept draws the current starting point of the contour.

After selection of the symbol you have to enter the new starting point of the contour.



Change direction

CAMConcept draws the current working direction.

After selection of the symbol the working direction can be reversed.

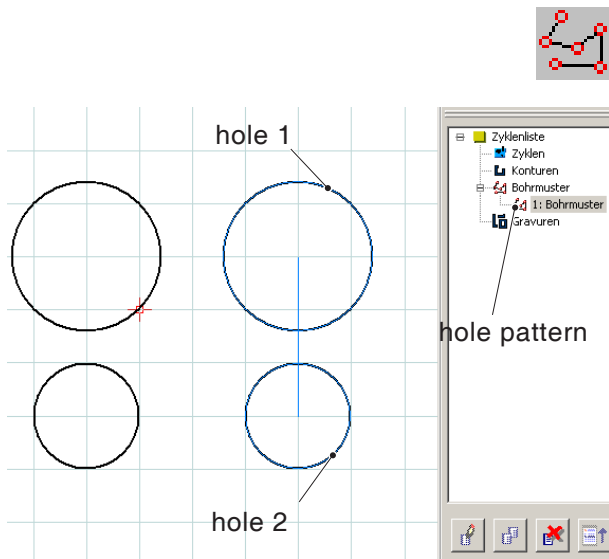

Connecting circles to hole patterns

Hole pattern

With hole patterns several drilling or threading operations with the same diameter can be machined together in one cycle.

Defined hole patterns are saved in the window "Machining steps". The saved hole patterns can be renamed or deleted.

In order to be able to define a hole pattern in the CAM mode, holes must be drawn as point or full circle in the CAD mode.



Save hole pattern

Hole patterns can be saved in the window "Machining steps".

With this symbol holes or threads can be defined as hole patterns after having been selected by means of the mouse.



Cancel hole pattern

This symbol enables to cancel an already defined selection of bores or threads (holes or threads with changed colour). The hole pattern will not be saved.

Note:

Use the right mouse button to cancel a selection of bores or threads (circles with changed colour) by one bore or one thread each. The hole pattern can always be saved.



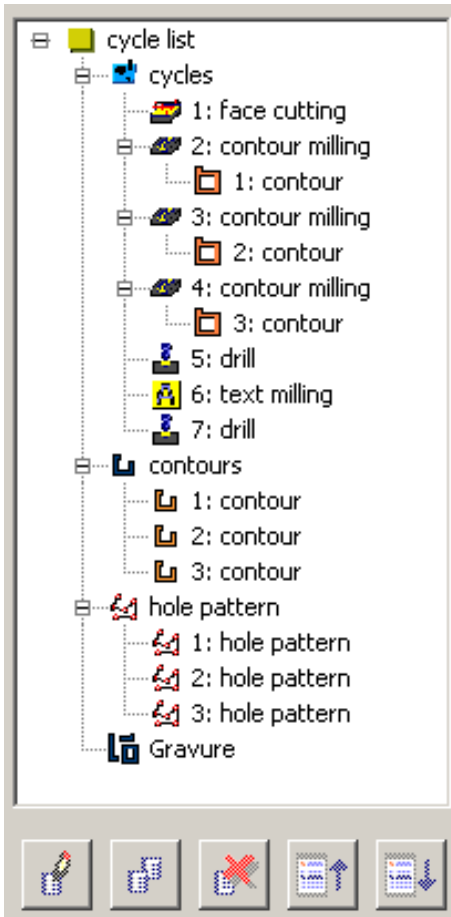

Working window for cycles, contours and hole patterns

Cycles

Defining cycles

The icon list shows the various cycle groups.

- Select cycle group.
- Select cycle.
- Enter all required parameters.
- Terminate the input with the soft key "Capture F8".

After having defined the machining cycles, they will be saved one after the other in the right-hand window "Machining steps".

Contours and hole patterns that have already been defined are saved in this window as well (see chapter ("Enter contour" or "Hole pattern"))



Edit selected cycle

This symbol enables to edit a cycle again that has been defined and stored before. CAMConcept switches to the cycle window.

Press the Soft key "Capture F8" to end the editing process. CAMConcept will return to the initial display mode.



Copy selected entry

This symbol enables to copy a stored cycle, a contour or a hole pattern. The copy will be put at the end of the cycle list or contour list.

A cycle having been deleted by mistake can be restored by means of the symbol "Undo".



Delete selected entry

This symbol enables to delete a stored cycle, a contour or a hole pattern. You can only delete contours that are or not linked in machining cycles.

Cycles and contours that have been deleted by mistake can be restored by means of the symbol "Undo".



Shift cycle

These symbols enable to alter the machining sequence of the stored cycles.

2D-Simulation



Turning the 2D simulation on and off

You can check the programmed machining cycles in a 2D simulation at any time. CAMConcept draws all 2D traversing movements of the tools.

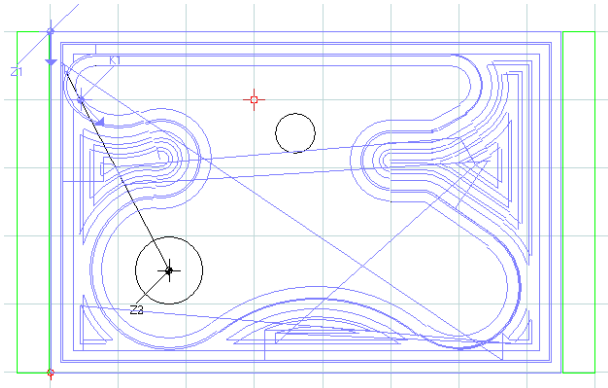

Tool traversing motions – 2D-simulation

2D-simulation of a cycle

If the cycle has been selected in the list, it can be run in the 2D simulation via NC-Start (with display of one tool).



Alarms of the 2D simulation

This symbol signals that CAMConcept has found one or more errors in the 2D simulation. Press the symbol to open the alarm window. The alarm messages are listed in the alarm window. With "Delete" the alarms are acknowledged and deleted. With "OK" the alarms are confirmed and remain in the alarm list.

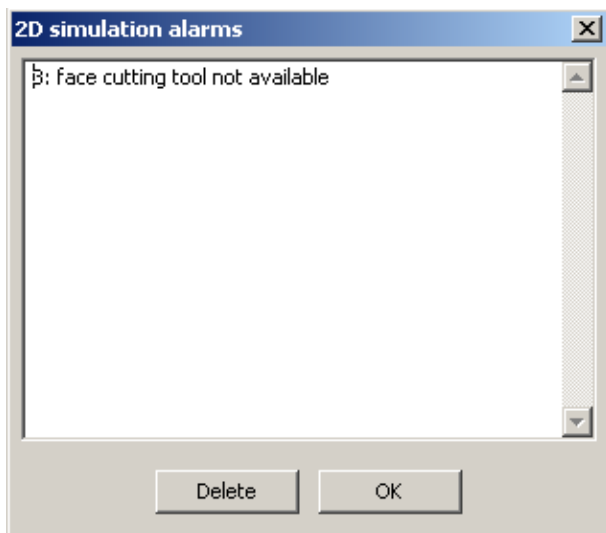

**Start of the 2D simulation**

The dynamic simulation is started with this symbol. Tool movements are shown.

A CAMConcept project must be open in order to be able to start the simulation. The file name of the CAMConcept project being open at the moment is displayed in the upper center of the simulation window (e.g. flange9.ecc).

**2D simulation reset**

With this symbol the simulation and the CNC program are aborted and they return to their initial state.

**2D simulation stop**

With this symbol the simulation and the CNC program are stopped. The simulation can be continued by means of the symbol "NC start".

**2D simulation single block on/off**

This symbol enables to stop the simulation after every block.

The simulation can be continued by means of the symbol "NC start".

**ZX view on/off**

With this symbol the simulation window can be splitted. No the lower window additionally displays the elevation.

The window layout can be shifted by the mouse as required.

Geom-etry

Input of geometry data

Current actual values

Input box for geometry data: Use the mouse or the cursor keys to select the boxes.

Select boxes: can be selected by means of the mouse or the cursor keys and can be shifted by pressing the left mouse button or the key combination "Strg + F".

Soft key for input of technology data.

Input of geometry data

The symbols display the cycles that are additionally available in the respective cycle group.

Softkey for return to the drawing for selection of a point and its transmission to the marked enter field.

Softkey for return to the drawing for selection of a whole element and its transmission to marked enter fields.



Note:

Use the mouse or the soft keys "Prior variant F1" or "Next variant F2" to select further cycles in the cycle group.

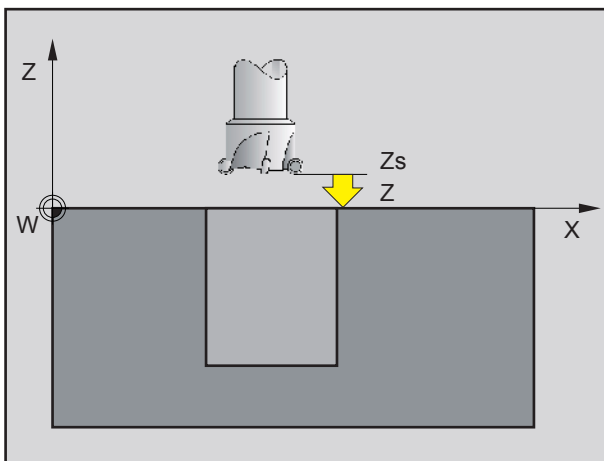

Safety plane

You can define an approaching height ("safety axis position") that will be traversed prior to the cycle starting point, so as to avoid collisions with the workpiece during cycles.

The safety plane Zs defines the approaching height in relation to the cycle starting point.

Get position

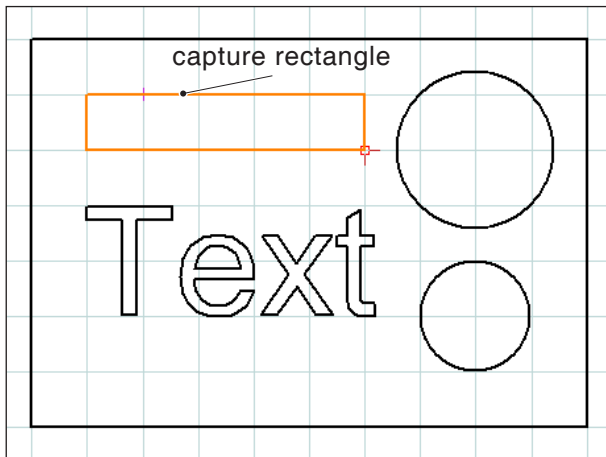

Selection of the elements to be captured here: select rectangle and capture it

Taking coordinates of elements from the CAD drawing

After having selected the soft key "Insert elements F3", CAMConcept switches into the CAD mode. Depending on the cycle selected, the geometry values of rectangles, circles or text can be directly inserted into the cycle input mask. Use the left mouse button to select the element in the CAD drawing you wish to take. CAMConcept switches into the CAM mode again and transfers the geometry values.

The transfered values change their colour. A changed colour indicates that the values have been inserted from a CAD drawing. When inserted values are altered by keyboard entry, they lose their colour marking again.

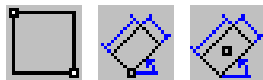

Note:

When rectangles are inserted, only those will be inserted that have been drawn with the CAD drawing function "Rectangle" or "Rotated rectangle".

Save elements

With this symbol elements that have been selected before are taken into the cycle.

Cancel elements

Use this symbol to cancel already selected elements (elements with changed colour). The geometry data will not be imported into the cycle.

Note:

Use the right mouse button to cancel already selected elements (elements with changed colour) by one element each.



Taking coordinates of points from the CAD drawing

After selection of the soft key "Insert points F4" CAMConcept switches into the CAD mode. Use the left mouse button to select the points in the CAD drawing you wish to take. CAMConcept changes into the CAM mode again and transfers the coordinate values. The imported values change their colour.



Save points

With this symbol points that have been selected before are taken into the cycle.



Cancel points

Use this symbol to cancel already selected points. The geometry data will not be imported into the cycle.

**Note:**

Use the right mouse button to cancel already selected points (points with changed colour) by one point each.

Techno-
logy F6

Input of technology data

Current actual value

Input box for technology data: Selection of the boxes by means of the mouse or the cursor keys.

Select boxes: can be selected with the mouse or with the cursor keys. They can be activated or deactivated by pressing the left mouse button or the key combination "Strg + F".

Coolant on / off

Shortcut to the tool data.

Softkey for entering geometry data.

The symbols display the additionally available cycles of the corresponding cycle group.

Spindle speed [rpm]

The spindle speed is entered under the parameter S. You can program different spindle speeds for the roughing and the finishing pass.

Direction of rotation

clockwise / counter-clockwise

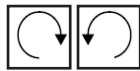

Feed rate [mm/min]

The feed rate is entered under the parameter F. You can program different feed rates for the roughing and the finishing pass.

Tool

Enter the respective tool and the tool correction under T and D (several correction values are possible per tool). For the roughing and finishing pass of working-off cycles (e.g. milling) you can program different tools (see chapter E tool programming).

Complete machining

Define a tool for roughing and finishing. Both cycles will be carried out one after the other with the respective settings and tools.

You can select different feed rates, spindle speeds and tools for both roughing and finishing. For already defined tools, after being selected, the corresponding spindle speeds and feed rates will be entered as changeable suggestion. When different tools have been defined for roughing and finishing, the toolholder will automatically traverse a tool changing point.

Roughing

Select the tool T0 as finishing tool. Then the finishing cycle will not be carried out. A defined finishing clearance will be considered during roughing.

Finishing

Select the tool T0 as roughing tool. Then the roughing cycle will not be carried out.

Coolant

turning the coolant on / off



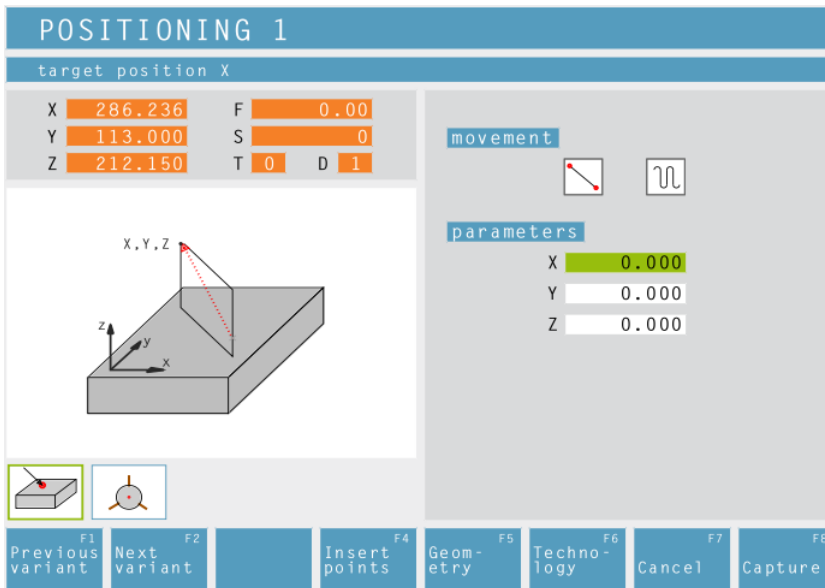

Positioning

You can traverse or position the tool in a straight way.

Use:

- to position the tool prior to the machining itself
- to traverse the tool between two cycles

Geometry



The tool traverses from its current position to its target position in a straight line.



The tool traverses from its current position first in Z and then in XY to its target position.



The tool traverses from its current position first in XY and then in Z to its target position.



The tool moves at rapid traverse.



The tool moves at the programmed feed rate F.

Coordinates

The target position is defined by X, Y and Z.

Technology

Then, please enter all necessary technological data (tool number, direction of rotation, feed rate, spindle speed).

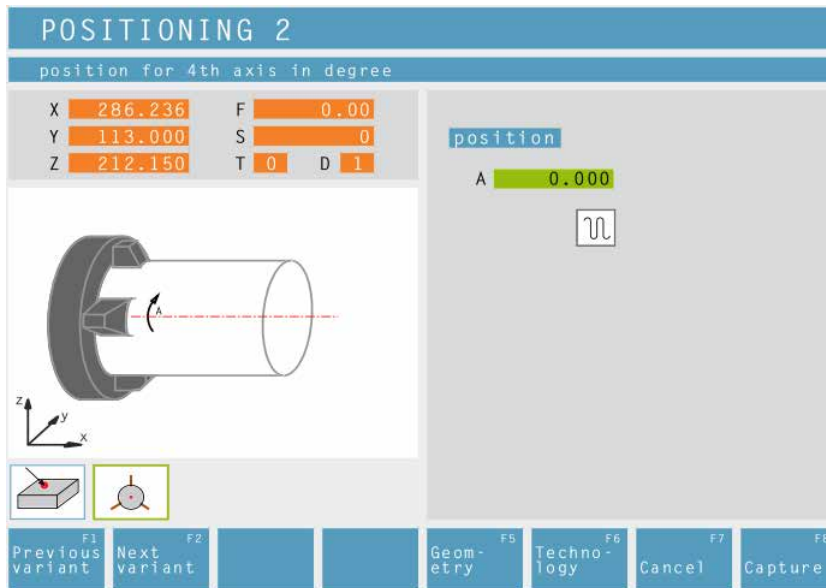

Positioning 2

Selection of the cycle from the cycle group with the softkeys "Previous variant F1" and "Next variant F2".

You can freely position the A-axis by entering an angle.

Geom-
etry

Axis position (A)

Position of the 4th axis in degrees



Traversing with a programmed feed rate

Input of the diameter for the feed calculation

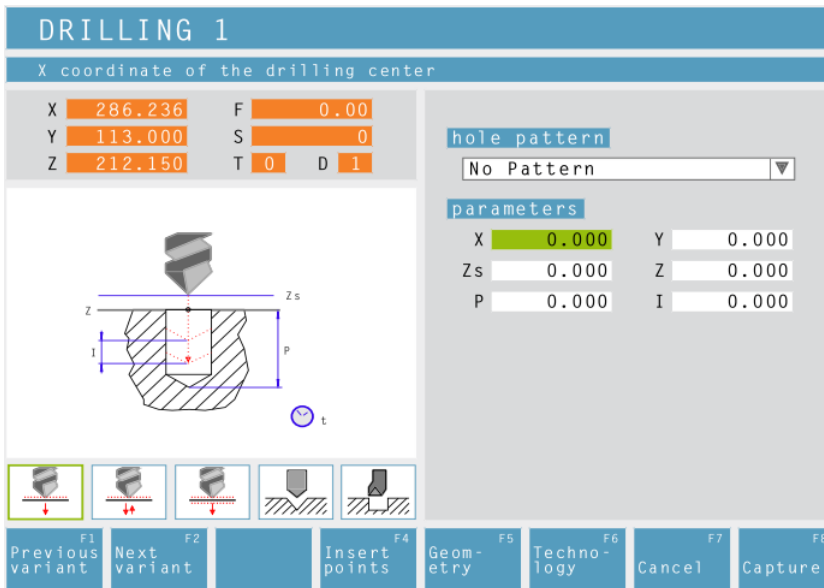

Drilling 1



Choice of cycle from the cycle group using the soft-keys "Previous option" and "Next option"

Geom-
etry

Hole patterns

Select a defined hole pattern from the selection list.

Coordinates (X, Y)

Coordinates of the drilling centre point

Safety axis position in Z (Zs)

Coordinate value of the workpiece in Z (Z)

Depth (P)

Drilling steps (I)

The infeed drilled per pass.



Continue by entering all the required technology data (tool number, direction of rotation, feed, spindle rotation speed).

DRILLING 1

number of the tool to be used

X	286.236	F	0.00
Y	113.000	S	0
Z	212.150	T	0
		D	1

machining

T	0	D	0	
F	0.000	S	0	
t	0.000			

general

F1
Previous
variant

F2
Next
variant

F4
Tool
table

F5
Geom-
etry

F6
Techno-
logy

F7
Cancel

F8
Capture

Time spent on the ground in seconds (t)

Cycle description

- 1 The control positions the tool in the spindle axis at high speed on the safety level (Zs) above the workpiece surface.
- 2 The tool drills with the programmed feed rate (F) to the defined depth (first defined depth= Z-l; second defined depth=Z- 2*l).
- 3 The control moves the tool at high speed back to the safety level and travels to position=set depth+Zs-Z
- 4 Then the tool drills with the entered feed rate to the next defined depth.
- 5 The control repeats this process (2 to 4), until the entered drilling depth has been achieved and stays there – if entered.
- 6 From the drilling area the tool travels back at high speed to the safety level (Zs).

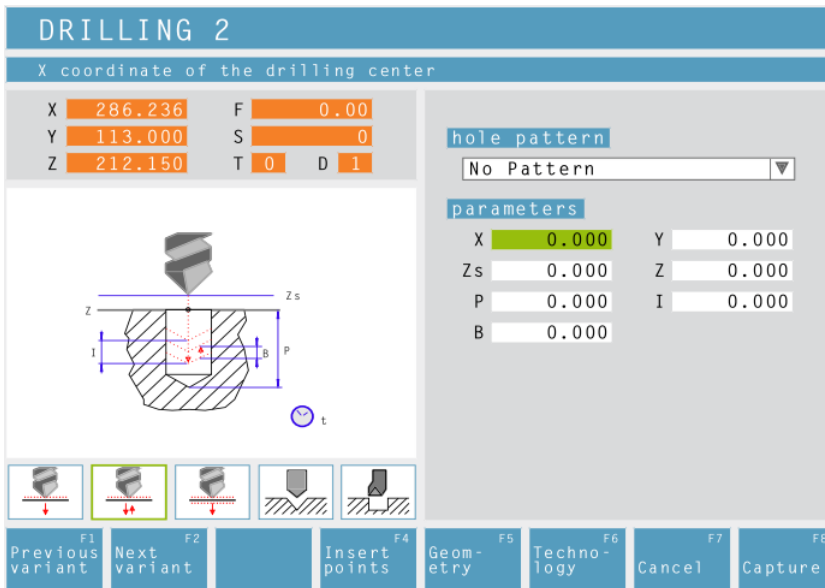

Drilling 2



Choice of cycle from the cycle group using the soft-keys "Previous option" and "Next option"



Drill pattern

Select a previously defined drill pattern from the list, or use the soft-key to create a new drill pattern (See Chapter C – "Drill Pattern Maintenance").

Co-ordinates (X, Y)

Co-ordinates of the drill mid-point

Safety axial position in Z (Zs)

Co-ordinate values of the workpiece in Z (Z)

Depth (P)

Drill steps (I)

Defined depth to be drilled in one pass.

Pull back distance (B)

Distance the tool travels back to the peck drill.



Continue by entering all the required technology data (tool number, direction of rotation, feed, spindle rotation speed).

Time spent on the ground in seconds (t)

Cycle description

- 1** The control positions the tool in the spindle axis at high speed on the safety level (Zs) above the workpiece surface.
- 2** The tool drills with the programmed feed rate (F) to the defined depth (first defined depth= Z-I).
- 3** The control moves the tool back at high speed as far as the withdrawal distance (B).
- 4** Then the tool drills with the entered feed rate to the next defined depth.
- 5** The control repeats this process (2 to 4), until the entered drilling depth has been achieved and stays there - if entered.
- 6** From the drilling area the tool travels back at high speed to the safety level (Zs).

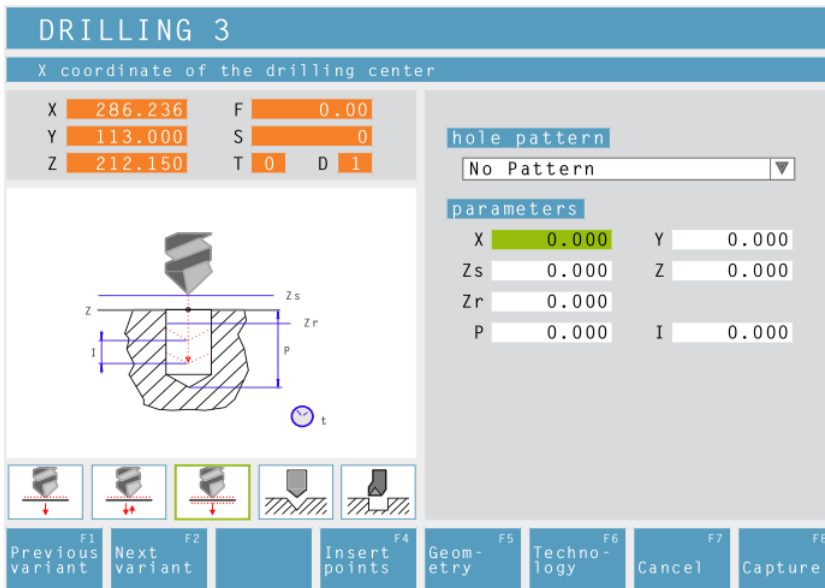

Drilling 3



Choice of cycle from the cycle group using the soft-keys "Previous option" and "Next option"



Drill pattern

Select a previously defined drill pattern from the list, or use the soft-key to create a new drill pattern (See Chapter C – "Drill Pattern Maintenance").

Co-ordinates (X, Y)

Co-ordinates of the drill mid-point

Safety axial position in Z (Zs)

Co-ordinate values of the workpiece in Z (Z)

Co-ordinate values of the withdrawal (Zr)

Depth (P)

Drill steps (I)

Defined depth to be drilled in one pass.



Continue by entering all the required technology data (tool number, direction of rotation, feed, spindle rotation speed).

Time spent on the ground in seconds (t)

Cycle description

- 1** The control positions the tool in the spindle axis at high speed on the safety level (Zs) above the workpiece surface.
- 2** The tool drills with the programmed feed rate (F) to the defined depth (first defined depth=Z-1; second defined depth=Z- 2*1).
- 3** The control moves the tool at high speed back to the withdrawal level and travels to position=defined depth+Zs-Z.
- 4** Then the tool drills with the entered feed rate to the next defined depth.
- 5** The control repeats this process (2 to 4), until the entered drilling depth has been achieved and stays there – if entered.
- 6** From the drilling area the tool travels back at high speed to the safety level (Zs).

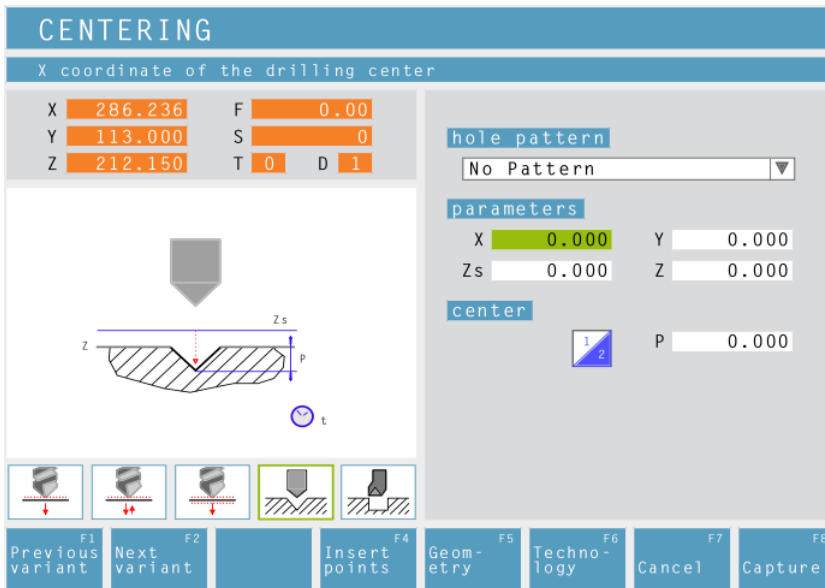

Centering



Choice of cycle from the cycle group using the soft-keys "Previous option" and "Next option"



Drill pattern

Select a previously defined drill pattern from the list, or use the soft-key to create a new drill pattern (See Chapter C – "Drill Pattern Maintenance").

Co-ordinates (X, Y)

Co-ordinates of the drill mid-point

Safety axial position in Z (Zs)

Co-ordinate values of the workpiece in Z (Z)

Type of punching:

Definition by processing depth (P)

Definition by punching angle (α) and punching diameter (\emptyset)



Continue by entering all the required technology data (tool number, direction of rotation, feed, spindle rotation speed).

Time spent on the ground in seconds (t)

Cycle description

- 1** The control positions the tool in the spindle axis at high speed on the safety level (Zs) above the workpiece surface.
- 2** The tool centres with the programmed feed rate (F) until the depth (P) or punch diameter (\emptyset) is reached and stays there – if entered.
- 3** From the centering base the tool travels back at high speed to the safety level (Zs).

BORING

X coordinate of the drilling center

X	286.236	F	0.00
Y	113.000	S	0
Z	212.150	T	0
		D	1

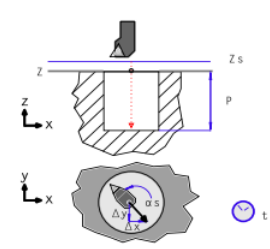

parameters	
X	0.000
Zs	0.000
P	0.000
Dx	0.000
Y	0.000
Z	0.000
αs	0.000
Dy	0.000

F1 Previous variant
F2 Next variant
F4 Insert points
F5 Geometry
F6 Technology
F7 Cancel
F8 Capture

Boring

F1
Previous
variant

F2
Next
variant

Selection of the cycle from the cycle group using the softkeys "Previous variant F1" and "Next variant F2".

Cycle not possible on CM/CT 55/105 machines.

Geom-
etry

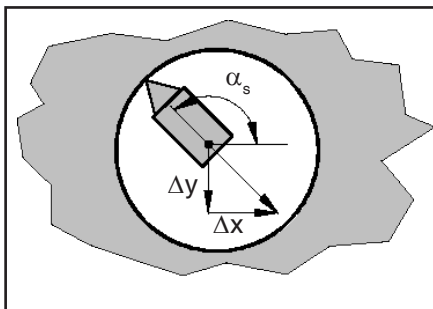

F6
Techno-
logy

Coordinates (X, Y)

Coordinates of the drilling centre point

Safety axis position in Z (Zs)

Coordinate value of the workpiece in Z (Z)

Depth of the bore (P)

Position of the spindle during return motion (α_s)

Return position of the tool in X (Δx)

Return position of the tool in Y (Δy)

Also enter all other required technology data (tool number, direction of rotation, feed, spindle speed).

Dwell time at the bottom in seconds (t)

Coolant

Switch ON / OFF

Note:

The bore wall will be damaged if a stationary tool is moved out to the safety axis position. When using drilling tools with a smaller diameter than the required bore diameter, damage can be avoided by positioning the tool towards the centre of the bore before moving it out.

This positioning is enabled through an angle α_s in relation to the X-axis and the incremental traverse values Δx and Δy .

In the case of the incremental traverse values Δx and Δy , care must be taken to use the correct sign. A negative sign means a traversing motion in the direction of the negative coordinate axis.

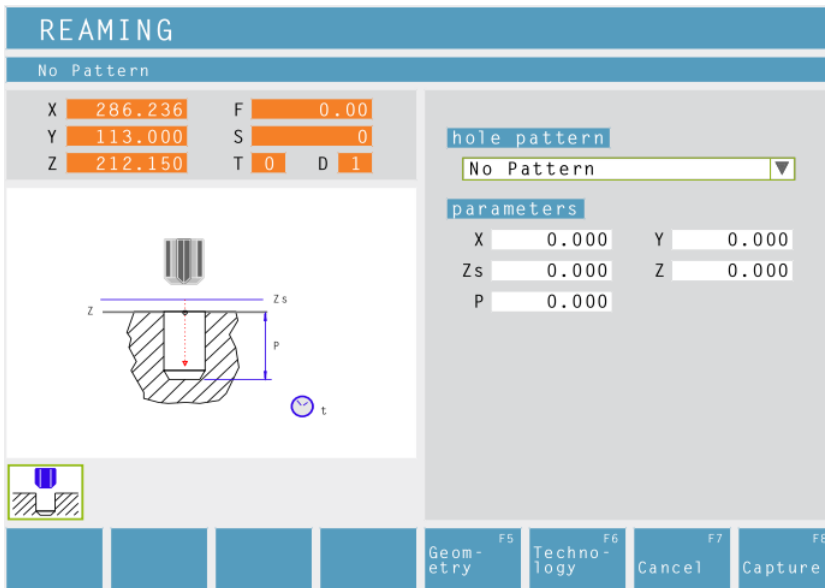

Rasping

Geom-
etry

Drill pattern

Select a previously defined drill pattern from the list, or use the soft-key to create a new drill pattern (See Chapter C – "Drill Pattern Maintenance").

Co-ordinates (X, Y)

Co-ordinates of the drill mid-point

Safety axial position in Z (Zs)

Starting height Z (Z)

Depth (P)

Techno-
logy

Continue by entering all the required technology data (tool number, direction of rotation, feed, spindle rotation speed).

Time spent on the ground in seconds (t)

Cycle description

- 1** The control positions the tool in the spindle axis at high speed on the safety level (Zs) above the workpiece surface.
- 2** The tool rasps with the programmed feed rate (F) to depth (P) and stays there – if entered.
- 3** From the rasping area the tool travels back with the programmed feed rate (F) to the safety level (Zs).

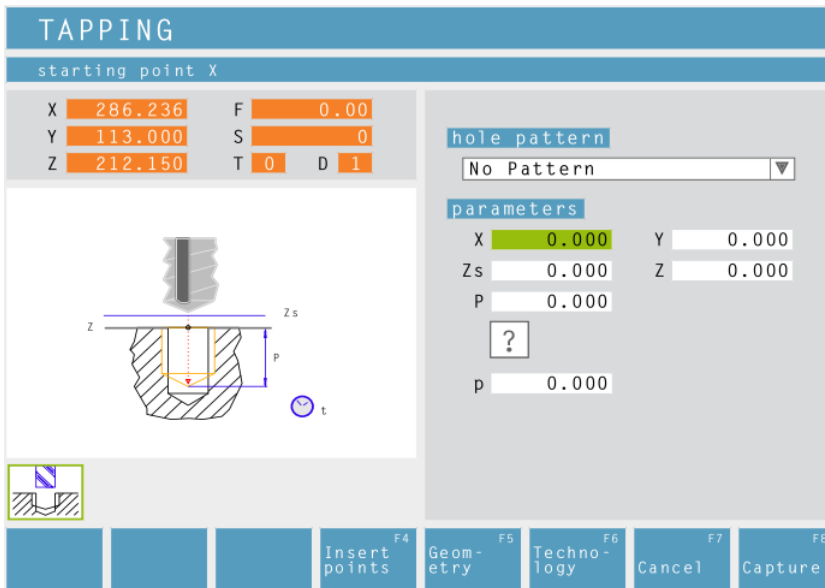

Tapping Cycle

Geom-
etry

Drill pattern

Select a previously defined drill pattern from the list, or use the soft-key to create a new drill pattern (See Chapter C – "Drill Pattern Maintenance").

Co-ordinates (X, Y)

Co-ordinates of the drill mid-point

Safety axial position in Z (Zs)

Starting height Z (Z)

Depth (P)

Thread type

The following standard thread types are available:

- ? Freely defined thread
- 60 MM M (S.I.F) Metric Fine Thread
- 60 MM M (S.I.F) Metric Fine Thread
- 55 INCH B.S.W. British Standard Whitworth Thread (normal width)
- 55 INCH B.S.F British Standard Fine thread
- 60 INCH U.N.C. Unified Coarse Thread
- 60 INCH U.N.F. Unified Fine Thread

Note:

Using the thread type "Freely defined thread" the thread pitch p can be freely defined.

For all other thread types once you have entered the thread diameter \varnothing the thread pitch p will be automatically pre-set using standard values.

If a non-standard thread diameter is entered, EASY CYCLE will automatically replace it with the next largest standard diameter.

Thread diameter (\varnothing)

Thread pitch (p)



Continue by entering all the required technology data (tool number, direction of rotation, spindle rotation speed).

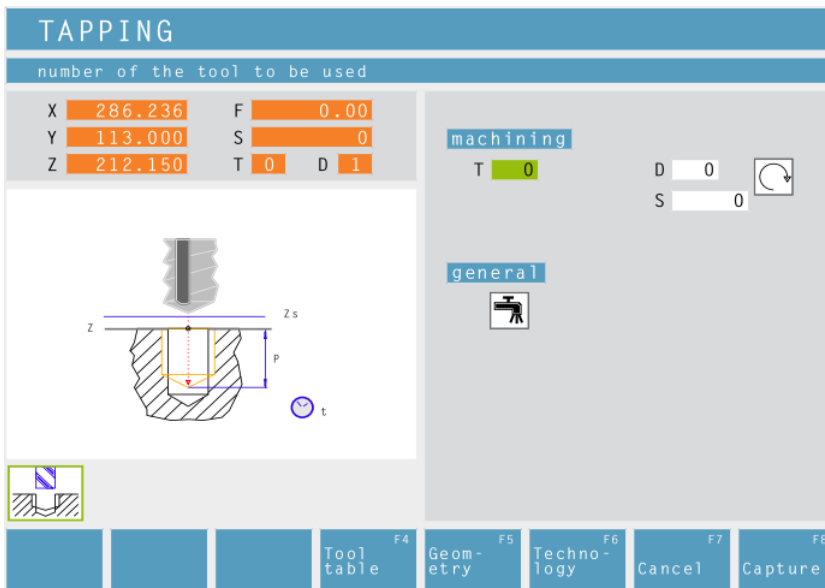

Calculate feed rate: $F = S \times p$

F: Feed rate [mm/min]

S: Revolutions [R/min]

p: Thread pitch (p)

Cycle description

- 1 The control positions the tool in the spindle axis at high speed on the safety level (Zs) above the workpiece surface.
- 2 The tool moves in one pass to the thread depth (P). The control calculates the feed rate (F) as a function of the revolutions (S). If you use the knob to over-ride the revolutions while drilling the thread, then the feed rate is automatically adjusted to match.
- 3 Then the spindle direction is reversed and the tool is moved back to the starting position.
- 4 On the safety level (Zs) the spindle direction is reversed again.

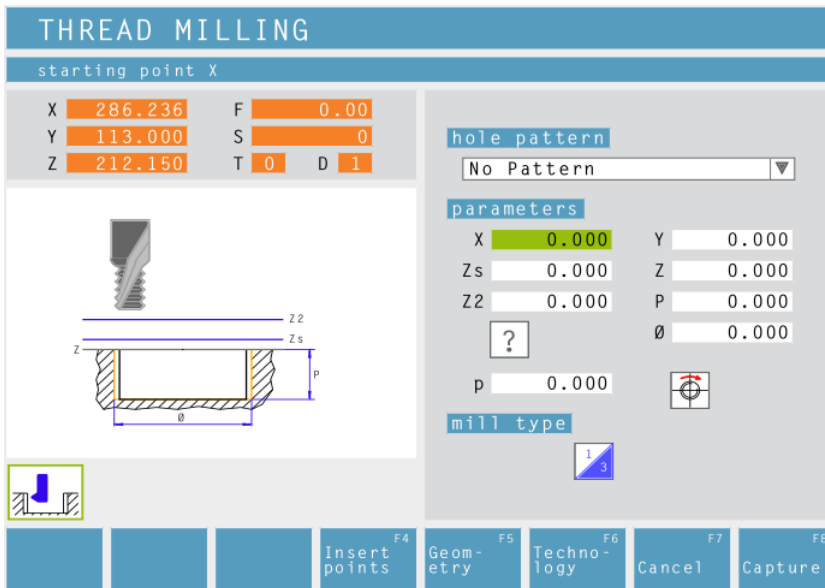

Thread milling

Geom-etry

Drill pattern

Select a previously defined drill pattern from the list, or use the soft-key to create a new drill pattern (See Chapter C – "Drill Pattern Maintenance")

Co-ordinates (X, Y)

Co-ordinates of the start position

Safety axial position in Z (Zs)

Starting height Z (Z)

Safety axial position in Z (Collision protected) (Z2)

Depth (P)

Thread type

The following standard thread types are available:

- ? Freely defined thread
- 60 MM M (S.I.F) Metric Fine Thread
- 60  M (S.I.F) Metric Fine Thread
- 55 INCH B.S.W. British Standard Whitworth Thread (normal width)
- 55  INCH B.S.F British Standard Fine thread
- 60 INCH U.N.C. Unified Coarse Thread
- 60  INCH U.N.F. Unified Fine Thread

Note:

Using the thread type "Freely defined thread" the thread pitch p can be freely defined. For all other thread types once you have entered the thread diameter \varnothing the thread pitch p will be automatically pre-set using standard values. If a non-standard thread diameter is entered, EASY CYCLE will automatically replace it with the next largest standard diameter.



Thread diameter (\varnothing)

Thread pitch (p)



Mill type:
a 360° screw line to the thread depth



continuous screw line along the full length of the thread



several helical tracks with start and finish
Number of thread turns by which the tool is moved (N)



Continue by entering all the required technology data (tool number, direction of rotation, feed, spindle rotation speed).

THREAD MILLING

number of the tool to be used

X	286.236	F	0.00
Y	113.000	S	0
Z	212.150	T	0
		D	1

machining

T D

F S

f

general

Tool table F4
Geom-etry F5
Techno-logy F6
Cancel F7
Capture F8

Processing speed in the workpiece (pre-positioning feed rate) (f)



Coolant
turning the coolant on / off

FACE MILLING
P 2
rechtecktasche

starting point X

X	-110.000	F	0.00		
Y	10.000	S	0		
Z	55.000	T	0	D	1

movement

parameters

X	0.000	Y	0.000
L	0.000	H	0.000
E	0.000	α	0.000
Zs	0.000	Z	0.000
P	0.000	I	0.000

Previous variant
Next variant
Get position
Geometry
Technology
Cancel
Capture

Face milling



Choice of cycle from the cycle group using the soft-keys "Previous option" and "Next option"

Geometry

Direction of travel

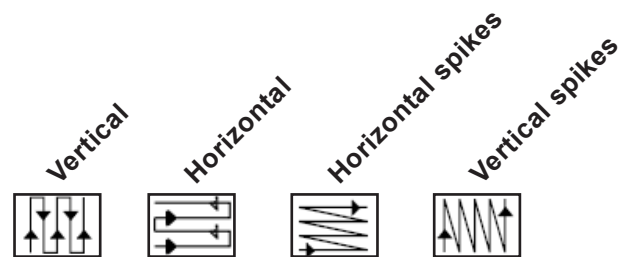

Starting position:

Vertex at which the mill starts to work.

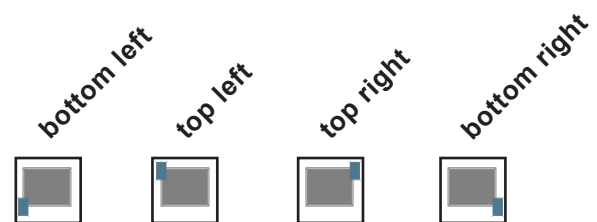

Co-ordinates (X, Y)

Co-ordinates of the start position

Length of the face milling area in X (L)

Length of the face milling area in Y (L)

Excess (E)

Angle relative to the X-Axis (α)

Safety axial position in Z (Zs)

Co-ordinate values of the workpiece in Z (Z)

Depth (P)

Setting in Z (I)

Note:
The excess E must be at least as large as the tool radius R.



Continue by entering all the required technology data (tool number, direction of rotation, feed, spindle rotation speed).

FACE MILLING
P 2
rechtecktasche

number of the tool to be used

X	-110.000	F	0.00
Y	10.000	S	0
Z	55.000	T	0
		D	1

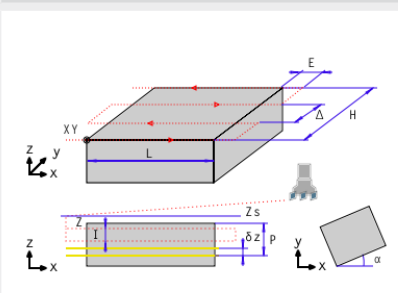

roughing

T D

F S

Δ

finishing

T D

F S

Δ

δz

general

Fz



Previous variant
Next variant
Tool table
Geometry
Technology
Cancel
Capture

Roughing setting (Δ)

Sideways distance the tool is moved when roughing

Finishing setting (Δ)

Sideways distance the tool is moved when finishing

Finishing setting in Z (δz)

Height to be left when roughing

Feed rate in Z (Fz)

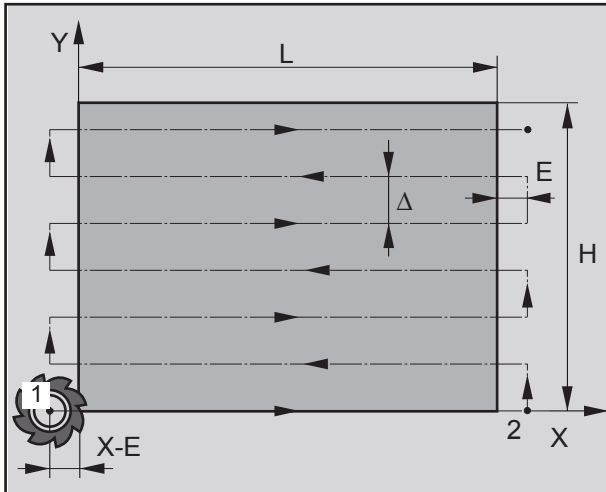

Direction of movement "horizontal"

Cycle description

(Description for movement in "horizontal" direction)

roughing

- 1 The tool travels in the spindle axis to the safety level (Z_s) and to start point 1. Start point 1 = $(X-E, Y)$. The tool is moved by the tool radius to the left and upwards.
- 2 Then the tool moves with feed rate (F_z) to the first defined depth (l) and rough mills with the programmed feed rate up to end point 2 in that level. The tool is moved each time by the roughing setting (Δ) diagonally to the start point of the next row. The end point is calculated from the programmed start point, the programmed length and the excess (E).
- 3 After which the tool travels away from the shape back to the starting point in the working plane and the set level (l).
- 4 This process (2 to 3) is repeated until the programmed roughing depth ($P-\delta z$) is reached.

finishing

- 5 The tool travels in the spindle axis to the safety level (Z_s) and to start point 1. Start point 1 = $(X-E, Y)$. The tool is moved by the tool radius to the left and upwards.
- 6 Then the tool travels using the feed rate (F_z) to depth (P) and finishes using the programmed finishing feed rate up to end point 2. The tool is moved by the finishing setting (Δ) vertically to the start point of the next row. The end point is calculated from the programmed start point, the programmed length and the excess (E).
- 7 Finally the tool is moved back at high speed to the safety level (Z_s).

SLOT MILLING

starting point X

X	286.236	F	0.00		
Y	113.000	S	0		
Z	212.150	T	0	D	1

direction

parameters

X	0.000	Y	0.000
L	0.000	H	0.000
E	0.000	alpha	0.000
Zs	0.000	Z	0.000
P	0.000	I	0.000

F1
Previous variant

F2
Next variant

F4
Insert points

F5
Geom-etry

F6
Techno-logy

F7
Cancel

F8
Capture

Slot milling



Choice of cycle from the cycle group using the soft-keys "Previous option" and "Next option"

Geom-etry

Slot direction:

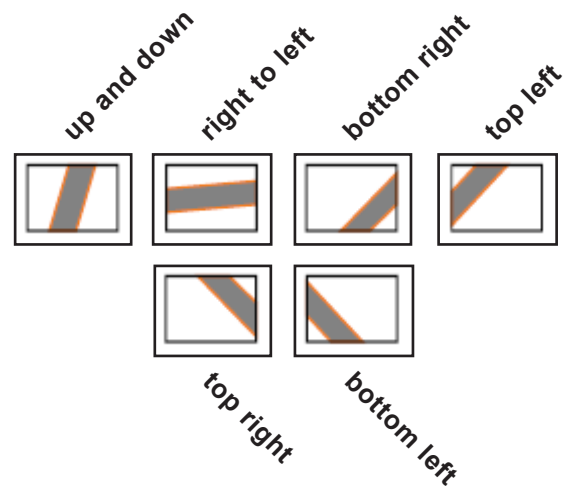

Co-ordinates (X, Y)

Co-ordinates of the start position

Slot length (L)

Slot width (H)

Excess (E)

Angle relative to the X-Axis (α)

Safety axial position in Z (Zs)

Co-ordinate values of the workpiece in Z (Z)

Depth (P)

Setting in Z (I)

Note:
The excess E must be at least as large as the tool radius R.





Continue by entering all the required technology data (tool number, direction of rotation, feed, spindle rotation speed).

SLOT MILLING

number of the tool to be used

X	286.236	F	0.00
Y	113.000	S	0
Z	212.150	T	0
		D	1

roughing

T D

F S

Δ

finishing

T D

F S

δ N

δz

general

Fz

F1

Previous variant

F2

Next variant

F4

Tool table

F5

Geometry

F6

Technology

F7

Cancel

F8

Capture

Roughing setting (Δ)

Sideways distance the tool is moved when roughing

Finishing setting (δ)

Side thickness to be left when roughing

Finishing setting in Z (δz)

Height to be left when roughing

Direction of working

Forwards direction milling
Reverse direction milling

Feed rate in Z (Fz)



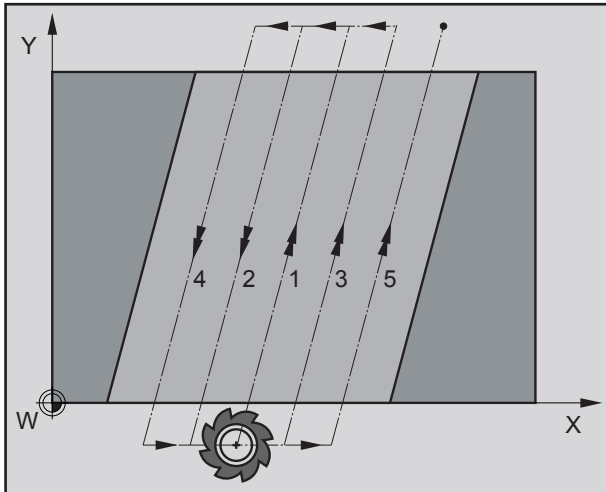

(Tool movement for slot direction "up and down")

Cycle description

(Description for slot direction "up and down")

roughing

- 1 The tool travels in the spindle axis to the safety level (Z_s) and to the middle of the slot. The tool is positioned, offset by the excess (E).
- 2 Then the tool moves using feed rate (F_z) to the first defined depth (l) and mills using the programmed rough feed rate in that plane. The tool is moved by the roughing setting (Δ) diagonally to the start point of the next row until the finishing setting (δ) stops on both sides of the slot.
- 3 After which the tool travels away from the shape back to the starting point in the working plane and the set level (l).
- 4 This process (2 to 3) is repeated until the programmed roughing depth ($P-\delta z$) is reached.

finishing

- 5 The tool travels in the spindle axis to the safety level (Z_s) and to the middle of the slot. The tool is positioned, offset by the excess (E).
- 6 Then the tool travels at feed rate (F_z) to depth (P) and finishes the slot using the programmed feed rate for finishing. The tool is moved each time by the roughing setting (Δ) diagonally to the start point of the next row.
- 7 Finally the tool is moved back at high speed to the safety level (Z_s).

SIMPLE POCKET
P 91
Flansch

starting point X

X	-110.000	F	0.00
Y	10.000	S	0
Z	55.000	T	0
		D	1

parameters

X	0.000	Y	0.000
L	0.000	H	0.000
Zs	0.000	Z	0.000
P	0.000	I	0.000

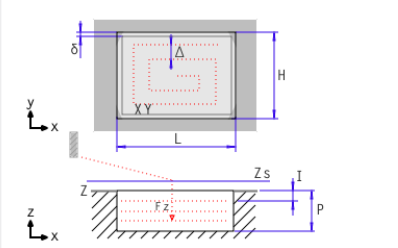

Previous variant
Next variant
Get position
Geometry
Technology
Cancel
Capture

Simple pocket



Choice of cycle from the cycle group using the soft-keys "Previous option" and "Next option"

Geom-etry

Co-ordinates (X, Y)

Co-ordinates of the start position

Pocket length in X (L)

Pocket length in Y (H)

Safety axial position in Z (Zs)

Co-ordinate values of the workpiece in Z (Z)

Depth of the pocket (P)

Setting in Z (I)



Continue by entering all the required technology data (tool number, direction of rotation, feed, spindle rotation speed).

SIMPLE POCKET
P 91
Flansch

number of the tool to be used

X	-396.236	F	0.00
Y	-103.000	S	0
Z	-157.150	T	0
		D	0

machining

T	0	D	0	
F	0.000	S	0	
Δ	0.000			
δ	0.000			
Fz	0.000			

general

Roughing setting (Δ)

For roughing the sideways rough setting is entered under Δ



Direction of working

Forwards direction milling
Reverse direction milling

Finishing setting (δ)

For finishing work enter under δ the side finishing setting which is to be left on roughing.

Feed rate in Z (Fz)

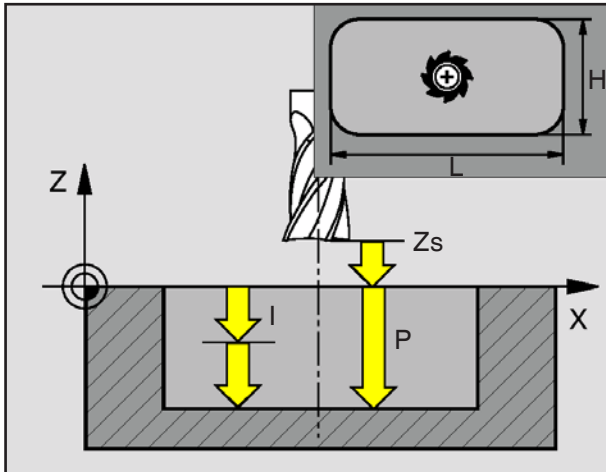
**Note:**

Roughing and finishing will be carried out using the same tool for this cycle.

**Cycle description****roughing**

- 1 The tool travels in the spindle axis to the safety level (Z_s) and to the middle of the pocket.
- 2 Then the tool travels with feed rate (F_z) to the first defined depth (I) and first in the positive direction of the longer side – for square pockets in the positive Y-direction – and cuts out the pocket from inside to out in forwards/backwards movement using the programmed feed rate for that level. The tool moves each time by the roughing setting (Δ) until the finishing setting (δ) remains at the pocket edges.
- 3 After which the tool travels away from the shape back to the starting point in the working plane and the set level (I).
- 4 This process (2 to 3) is repeated, until the depth (P) is reached.

finishing

- 5 The tool travels in the spindle axis to the safety level (Z_s) and to the middle of the pocket.
- 6 Then the tool travels at feed rate (F_z) to depth (P) and finishes the pocket using the programmed feed rate for finishing.
- 7 Finally the tool is moved back at high speed to the safety level (Z_s).

RECTANGULAR POCKET MILLING

starting point X

X	286.236	F	0.00
Y	113.000	S	0
Z	212.150	T	0
		D	1

parameters

X	0.000	Y	0.000
L	0.000	H	0.000
Zs	0.000	Z	0.000
P	0.000	I	0.000
α	0.000		

corner rounding

Previous variant F1

Next variant F2

Choice of cycle from the cycle group using the soft-keys "Previous option" and "Next option"

Previous variant F1

Next variant F2

Insert elements F3

Insert points F4

Geom-etry F5

Techno-logy F6

Cancel F7

Capture F8

Geom-etry

Co-ordinates (X, Y)

Co-ordinates of the start position

Pocket length in X (L)

Pocket length in Y (H)

Safety axial position in Z (Zs)

Co-ordinate values of the workpiece in Z (Z)

Depth (P)

Setting in Z (I)

Angle of the pocket relative to the X-Axis (α)

Corner shaping:

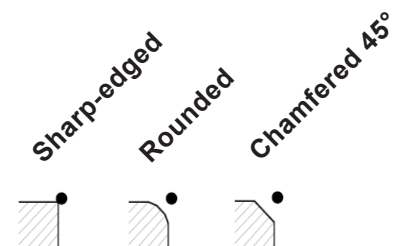

Technology

Continue by entering all the required technology data (tool number, direction of rotation, feed, spindle rotation speed).

RECTANGULAR POCKET MILLING

number of the tool to be used

X	286.236	F	0.00
Y	113.000	S	0
Z	212.150	T	0
		D	1

roughing

T	0	D	0
F	0.000	S	0
β	90.000		
Δ	0.000		

finishing

T	0	D	0
F	0.000	S	0
Θ	90.000	N	0
δ	0.000	δz	0.000

general

Fz	0.000
----	-------

Previous variant (F1) Next variant (F2) Insert elements (F3) Tool table (F4) Geometry (F5) Technology (F6) Cancel (F7) Capture (F8)

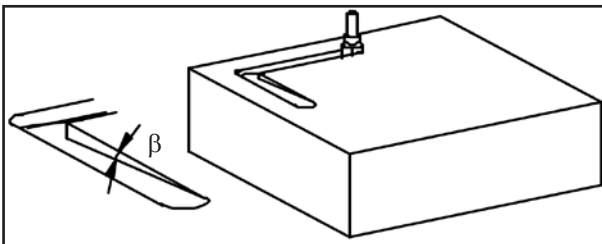

Angle of dip when roughing (β)

Angle of dip (β)

Angle of dip which the roughing tool sets when dipping to setting (I).

roughing setting (Δ)

Sideways distance the tool is moved when roughing

Angle of dip (Θ)

Angle of dip which the roughing tool sets when dipping to depth (P).

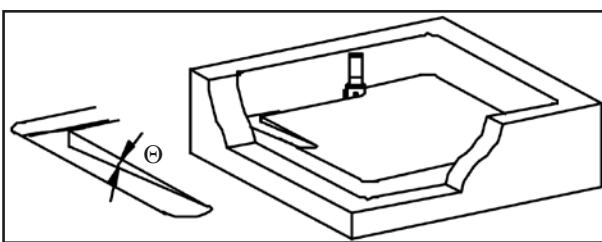

Angle of dip when finishing (Θ)

Number of finishing passes in Z (N)

Finishing setting (δ)

Side thickness to be left when roughing

Finishing setting in Z (δz)

Height to be left when roughing

Direction of working

Forwards direction milling
Reverse direction milling

Feed rate in Z (Fz)



Note:

The angles of dip β and Θ allow milling a pocket using milling tools which do not cut more than half way. Pre-boring is therefore not necessary. If the angles β and Θ are not defined, there is a possibility of the tool being damaged.



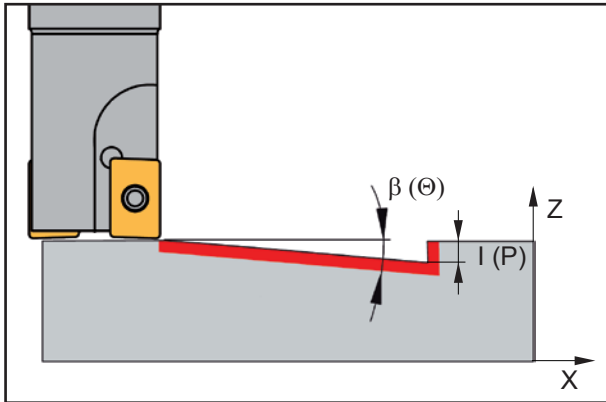

Cycle description roughing

- 1 The tool travels in the spindle axis to the safety level (Zs) and to the start position of the inside track.
- 2 Then the tool travels with feed rate (Fz) to the first defined depth (I) and first in the positive direction of the longer side – for square pockets in the positive Y-direction – and cuts out the pocket from inside to out in forwards/backwards movement using the programmed feed rate for that level. The tool moves each time by the roughing setting (Δ) until the finishing setting (δ) remains at the pocket edges.
The setting (I) is applied moving back and forwards along a sloping track using the angle of dip for roughing (β).
- 3 After which the tool travels away from the shape back to the starting point in the working plane and the set level (I).
- 4 This process (2 to 3) is repeated until the programmed roughing depth ($P-\delta z$) is reached.

Finishing depth

- 5 The tool travels in the spindle axis to the safety level (Zs) and to the start position of the inside track.
- 6 The tool then travels at high speed to position ($P-2*\delta z$). The tool travels back and forwards while using the angle of dip for finishing (Θ) to depth (P). The tool travels first in the positive Y-direction - and cuts out the pocket from the inside out moving backwards and forwards with the programmed feed rate for this plane. The tool moves each time by the roughing setting (Δ) until the finishing setting (δ) remains at the pocket edges.
- 7 The tool moves in the spindle axis to the safety level (Zs).

Finishing sidea

- 8 The tool travels to the middle of the pocket.
- 9 Then the tool travels at feed rate (Fz) to depth (P) and finishes the pocket using the programmed feed rate for finishing.
- 10 Finally the tool is moved back at high speed to the safety level (Zs).

CIRCULAR POCKET 1

X coordinate of the center

X	286.236	F	0.00		
Y	113.000	S	0		
Z	212.150	T	0	D	1

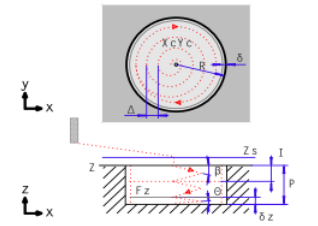

parameters

Xc	0.000	Yc	0.000
R	0.000	Z	0.000
Zs	0.000	I	0.000
P	0.000		

F1
Previous
variant

F2
Next
variant

F3
Insert
elements

F4
Insert
points

F5
Geom-
etry

F6
Techno-
logy

F7
Cancel

F8
Capture

Circular pocket 1



Selection of the cycle from the cycle group using the softkeys "Previous variant F1" and "Next variant F2".



Coordinates (Xc, Yc)
Coordinates of the centre point

Radius of the pocket (R)

Safety axis position in Z (Zs)

Coordinate value of the workpiece in Z (Z)

Depth (P)

Infeed in Z (I)



Also enter all other required technology data (tool number, direction of rotation, feed, spindle speed).

CIRCULAR POCKET 1

number of the tool to be used

X	286.236	F	0.00
Y	113.000	S	0
Z	212.150	T	0
		D	1

roughing

T 0 D 0

F 0.000 S 0

β 90.000

Δ 0.000

finishing

T 0 D 0

F 0.000 S 0

Θ 90.000 N 0

δ 0.000 δz 0.000

general

Fz 0.000

F1 Previous variant
F2 Next variant
F3 Insert elements
F4 Tool table
F5 Geometry
F6 Technology
F7 Cancel
F8 Capture

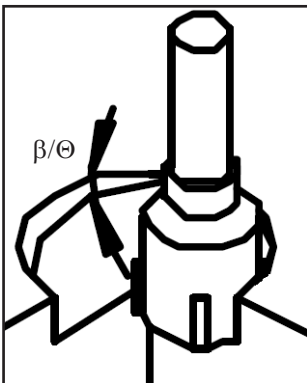

Plunge angle during roughing (β) / plunge angle during finish-machining (Θ)

Plunge angle (β)

Plunge angle at which the roughing tool is positioned during plunging in relation to the infeed (I).

Roughing infeed (Δ)

Lateral distance by which the tool is offset during roughing.

Plunge angle (Θ)

Plunge angle at which the finish-machining tool is positioned during plunging in relation to the depth (P).

Number of finish-machining passes in Z (N)

Finish-machining infeed (δ)

Lateral distance which is to remain during roughing.



Finish-machining infeed in Z (δz)

The height which is to remain during roughing.



Machining direction

Synchronous milling
Upcut milling



Feed in Z (Fz)

Coolant

Switch ON / OFF

Note:

The plunge angles β and Θ allow a pocket to be milled with milling tools which do not cut over the middle. Consequently, no pre-drilling is required. Without a definition of the angles β and Θ there is a risk that the tool could be damaged.



CIRCULAR POCKET 2

X coordinate of the center

X	286.236	F	0.00		
Y	113.000	S	0		
Z	212.150	T	0	D	1

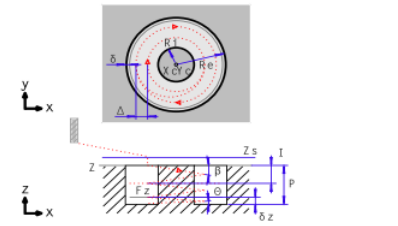

parameters

Xc	0.000	Yc	0.000
Re	0.000	Ri	0.000
Zs	0.000	Z	0.000
P	0.000	I	0.000

F1 Previous variant
F2 Next variant
F3 Insert elements
F4 Insert points

F5 Geometry
F6 Technology
F7 Cancel
F8 Capture

Circular pocket 2



Choice of cycle from the cycle group using the soft-keys "Previous option" and "Next option"



Co-ordinates (Xc, Yc)

Co-ordinates of the mid-point

Outside radius (Re)

Inside radius (Ri)

Safety axial position in Z (Zs)

Co-ordinate values of the workpiece in Z (Z)

Depth (P)

Setting in Z (I)



Continue by entering all the required technology data (tool number, direction of rotation, feed, spindle rotation speed).

CIRCULAR POCKET 2

number of the tool to be used

X	286.236	F	0.00
Y	113.000	S	0
Z	212.150	T	0
		D	1

roughing

T 0 D 0

F 0.000 S 0

β 90.000

Δ 0.000

finishing

T 0 D 0

F 0.000 S 0

Θ 90.000 N 0

δ 0.000 δz 0.000

general

Fz 0.000

F1 Previous variant
F2 Next variant
F3 Insert elements
F4 Tool table
F5 Geometry
F6 Technology
F7 Cancel
F8 Capture

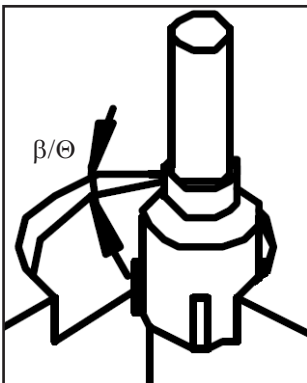

Angle of dip roughing (β) / Angle of dip finishing (Θ)

Angle of dip (β)

Angle of dip which the roughing tool sets when dipping to setting (I).

roughing setting (Δ)

Sideways distance the tool is moved when roughing

Angle of dip (Θ)

Angle of dip which the roughing tool sets when dipping to depth (P).

Number of finishing passes in Z (N)

Finishing setting (δ)

Side thickness to be left when roughing

Finishing setting in Z (δz)

Height to be left when roughing

Direction of working



Forwards direction milling



Reverse direction milling

Feed rate in Z (Fz)

Note:

The angles of dip β and Θ allow milling a pocket using milling tools which do not cut more than half way. Pre-boring is therefore not necessary. If the angles β and Θ are not defined, there is a possibility of the tool being damaged.



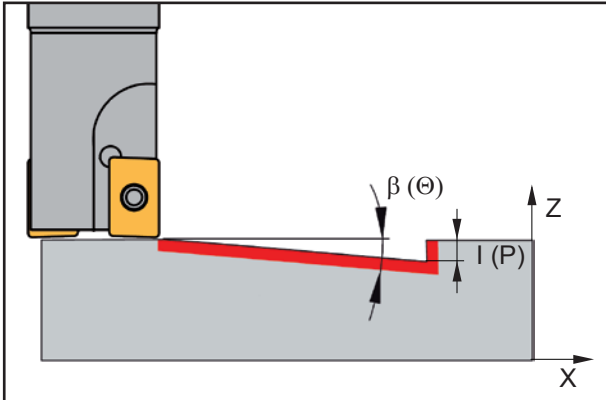

Cycle description roughing

- 1 The tool travels in the spindle axis to the safety level (Z_s) and to the position ($X_c + R_i + R + \delta$) and (Y_c).
- 2 Then the tool moves at feed rate (F_z) to the first defined depth (I) and cuts a spiral track around the island with backward/forward movements using the programmed feed rate. The tool moves each time by the roughing setting (Δ) until the finishing setting (δ) remains at the pocket and island edges. The setting (I) is applied moving back and forwards along a helical track using the angle of dip for roughing (β).
- 3 After which the tool travels away from the shape back to the starting point in the working plane and the set level (I).
- 4 This process (2 to 3) is repeated until the programmed roughing depth ($P - \delta z$) is reached.

Finishing depth

- 5 The tool travels in the spindle axis to the safety level (Z_s) and to the position ($X_c + R_i + R + \delta$) and (Y_c).
- 6 Then the tool moves at feed rate (F_z) to the first defined depth (I) and cuts a spiral track around the island with backward/forward movements using the programmed feed rate. The tool moves each time by the roughing setting (Δ) until the finishing setting (δ) remains at the pocket and island edges. The setting (I) is applied moving back and forwards along a helical track using the angle of dip for finishing (Θ).
- 7 The tool travels to the start position for finishing depth.

Finishing sidea

- 8 The tool travels in the spindle axis to the safety level (Z_s) and to the position ($X_c + (R_i + R)/2$) and (Y_c).
- 9 Then the tool travels at feed rate (F_z) to depth (P) and finishes first the pocket wall and then the island wall using the programmed feed rate.
- 10 The tool travels to the starting position for finishing sides and in high speed to the safety level (Z_s).

RECTANGULAR STUD

starting point X

X	286.236	F	0.00		
Y	113.000	S	0		
Z	212.150	T	0	D	1

parameters	
X	0.000
alpha	0.000
L	0.000
Zs	0.000
P	0.000
Y	0.000
Q	0.000
H	0.000
Z	0.000
I	0.000

corner rounding	
	<input type="checkbox"/>

F1 Previous variant
F2 Next variant
F3 Insert elements
F4 Insert points
F5 Geometry
F6 Technology
F7 Cancel
F8 Capture

Rectangular stud

F1
Previous
variant

F2
Next
variant

Choice of cycle from the cycle group using the soft-keys "Previous option" and "Next option"

Geom-etry

Co-ordinates (X, Y)

Co-ordinates of the start position

Angle of the rectangular stud relative to the X-Axis (α)

Material quantity (Q)

Length of the rectangular stud in X (L)

Length of the rectangular stud in Y (L)

Safety axial position in Z (Zs)

Co-ordinate values of the workpiece in Z (Z)

Depth (P)

Setting in Z (I)

Corner shaping:

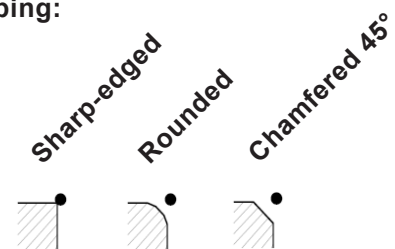



Continue by entering all the required technology data (tool number, direction of rotation, feed, spindle rotation speed).

RECTANGULAR STUD

number of the tool to be used

X	286.236	F	0.00
Y	113.000	S	0
Z	212.150	T	0
		D	1

roughing

T	0	D	0	
F	0.000	S	0	
Δ	0.000			

finishing

T	0	D	0	
F	0.000	S	0	
δ	0.000	N	0	
δz	0.000			

general

Fz	0.000	
----	-------	--

F1 Previous variant
F2 Next variant
F3 Insert elements
F4 Tool table
F5 Geometry
F6 Technology
F7 Cancel
F8 Capture

roughing setting (Δ)

Sideways distance the tool is moved when roughing

Number of finishing passes in Z (N)

Finishing setting (δ)

Side thickness to be left when roughing

Finishing setting in Z (δz)

Height to be left when roughing

Direction of working

Forwards direction milling

Reverse direction milling

Feed rate in Z (Fz)



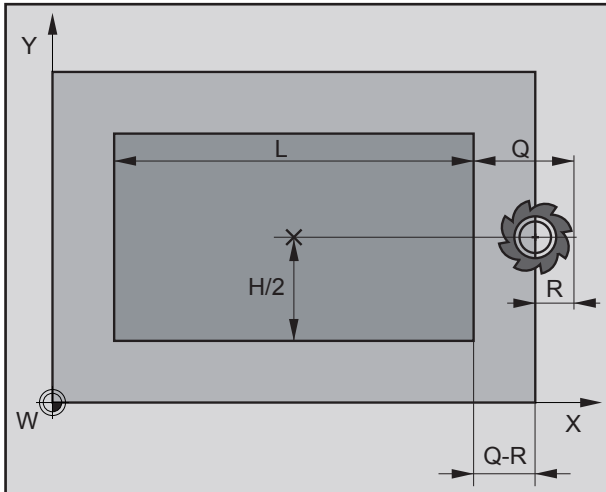

Starting position of the mill before roughing

R...Tool radius

Cycle description

Roughing

- 1 The tool travels in the spindle axis to the safety level (Z_s) and to the position $(X+L+Q-R)$ and $(Y+H/2)$ (see illustration).
- 2 Then the tool travels, using the feed rate (F_z), to the first defined depth(l) and mills forwards and backwards in one pass.
- 3 Before the next pass it is adjusted by the rough setting (Δ). The passes are repeated until the stud-measurement ($\delta + R$) is reached.
- 4 After which the tool travels away from the shape back to the starting point in the working plane and the set level (l).
- 5 This process (3 to 4) is repeated until the programmed roughing depth ($P-\delta z$) is reached.

Finishing depth

- 6 The tool travels in the spindle axis to the safety level (Z_s) and to the position $(X+L+Q-R)$ and $(Y+H/2)$ (see illustration).
- 7 Then the tool travels, allowing for the feed (F_z), to the first defined depth(l) and chamfers forwards and backwards in one pass.
- 8 Before the next pass it is adjusted by the rough setting (Δ). The passes are repeated until the stud-measurement ($\delta + R$) is reached.
- 9 Then the tool travels away from the shape.

Finishing sidea

- 10 The tool travels in the spindle axis to the safety level (Z_s) and to the position $(X+L+Q-R)$ and $(Y+H/2)$ (see illustration).
- 11 Then the tool travels to the blank shape and to depth (P) and finishes the stud travelling forwards and backwards.
- 12 At the end of the cycle the tool moves at high speed to the safety level (Z_s) and then to the centre of the stud.

CIRCULAR STUD

X coordinate of the center

X	286.236	F	0.00
Y	113.000	S	0
Z	212.150	T	0
		D	1

parameters	
Xc	0.000
Yc	0.000
R	0.000
Q	0.000
Zs	0.000
Z	0.000
P	0.000
I	0.000

--	--

F1 Previous variant	F2 Next variant
---------------------------	-----------------------

F1
Previous
variant

F2
Next
variant

F3
Insert
elements

F4
Insert
points

F5
Geom-
etry

F6
Techno-
logy

F7
Cancel

F8
Capture

Circular stud



Choice of cycle from the cycle group using the soft-keys "Previous option" and "Next option"



Co-ordinates (Xc, Yc)

Co-ordinates of the mid-point

Radius (R)

Material quantity (Q)

Safety axial position in Z (Zs)

Co-ordinate values of the workpiece in Z (Z)

Depth (P)

Setting in Z (I)



Continue by entering all the required technology data (tool number, direction of rotation, feed, spindle rotation speed).

CIRCULAR STUD

number of the tool to be used

X	286.236	F	0.00
Y	113.000	S	0
Z	212.150	T	0
		D	1

roughing		
T	0	D 0
F	0.000	S 0
Δ	0.000	
finishing		
T	0	D 0
F	0.000	S 0
δ	0.000	N 0
δz	0.000	
general		
Fz	0.000	

F1 Previous variant
F2 Next variant
F3 Insert elements
F4 Tool table
F5 Geometry
F6 Technology
F7 Cancel
F8 Capture

Roughing setting (Δ)

Sideways distance the tool is moved when roughing

Number of finishing passes in Z (N)

Finishing setting (δ)

Side thickness to be left when roughing

Finishing setting in Z (δz)

Height to be left when roughing

Direction of working

Forwards direction milling

Reverse direction milling

Feed rate in Z (Fz)



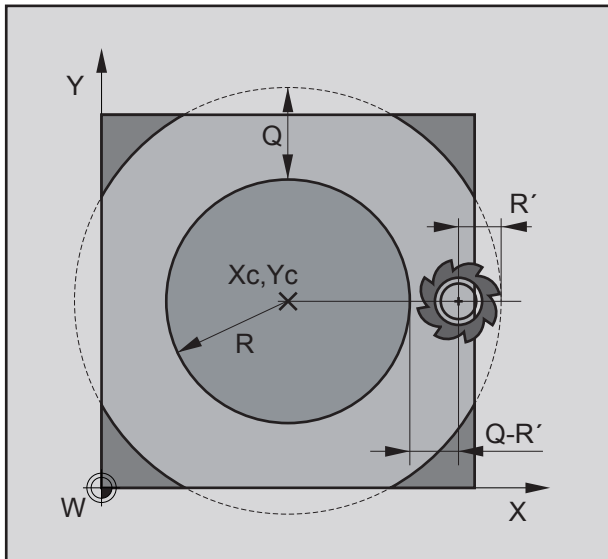

Starting position of the mill before roughing

R...Circular stud radius
R'...Tool radius

Cycle description

Roughing

- 1 The tool travels in the spindle axis to the safety level (Z_s) and to the position $(X+R+Q-R)$ and (Y_c) (see illustration).
- 2 Then the tool travels, using the feed rate (F_z), to the first defined depth(l) and mills forwards and backwards in one pass.
- 3 Before the next pass it is adjusted by the rough setting (Δ) . The passes are repeated until the stud-measurement ($\delta + R'$) is reached .
- 4 After which the tool travels away from the shape back to the starting point in the working plane and the set level (l).
- 5 This process (3 to 4) is repeated until the programmed roughing depth ($P-\delta z$) is reached.

Finishing depth

- 6 The tool travels in the spindle axis to the safety level (Z_s) and to the position $(X_c+R+Q-R')$ and (Y_c) .
- 7 Then the tool travels, allowing for the feed (F_z), to the first defined depth(l) and chamfers forwards and backwards in one pass.
- 8 Before the next pass it is adjusted by the rough setting (Δ) . The passes are repeated until the stud-measurement ($\delta + R'$) is reached .
- 9 Then the tool travels away from the shape.

Finishing sidea

- 10 The tool travels in the spindle axis to the safety level (Z_s) and to the position $(X_c+R+2*R')$ and (Y_c) .
- 11 Then the tool travels to the blank shape and to depth (P) and finishes the stud travelling forwards and backwards.
- 12 At the end of the cycle the tool moves at high speed to the safety level (Z_s) and then to the centre of the stud.

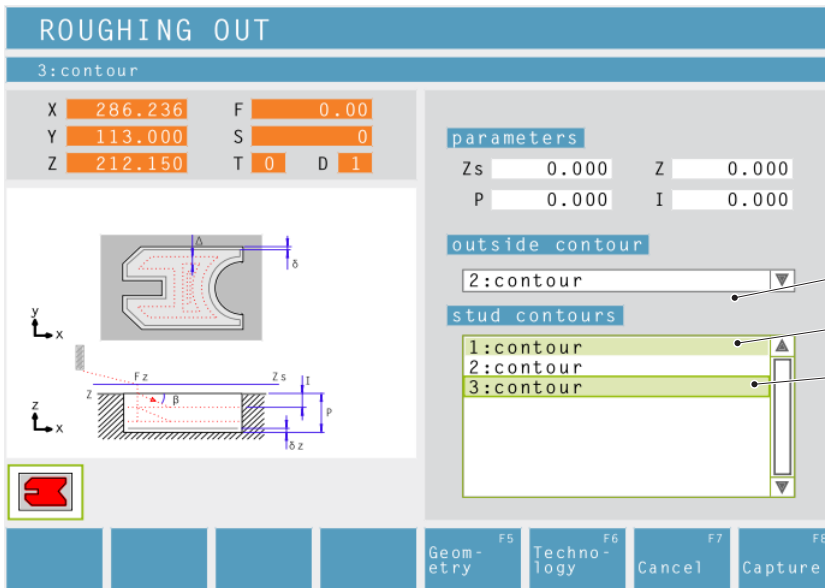

Roughing out

selected rim

selected island shapes

Geom-
etry

Safety axial position in Z (Zs)

Co-ordinate values of the workpiece in Z (Z)

Depth (P)

Setting in Z (I)

Rim

Select a previously defined shape from the list, or use the soft-key to create a new shape (See Chapter C – "Shapes Maintenance")

Island shape

3 possibilities

- Do not select an island shape
- Select an island shape
- Select several island shapes

Selected island shapes are displayed with a green bar.



Continue by entering all the required technology data (tool number, direction of rotation, feed, spindle rotation speed).

ROUGHING OUT

number of the tool to be used

X	286.236	F	0.00
Y	113.000	S	0
Z	212.150	T	0
		D	1

roughing	
T	0
F	0.000
β	90.000
D	0
S	0
Δ	0.000
finishing	
T	0
F	0.000
Θ	90.000
δ	0.000
N	0
δz	0.000
general	
Fz	0.000

Tool table F4
Geometry F5
Technology F6
Cancel F7
Capture F8

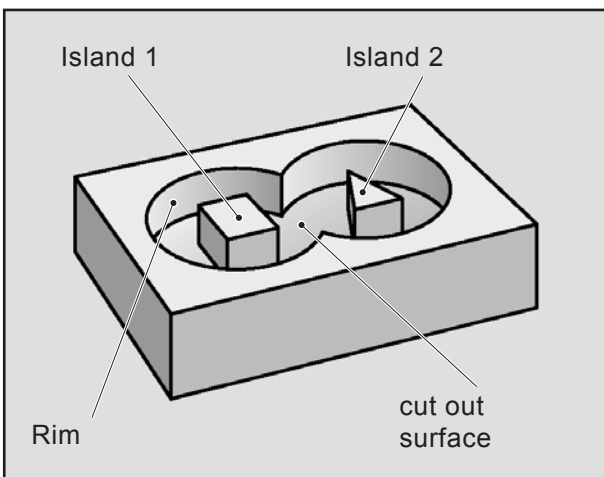

Example Rim /Island shapes

Angle of dip (β)

Angle of dip which the roughing tool sets when dipping to setting (I).

Roughing setting (Δ)

Sideways distance the tool is moved when roughing

Angle of dip (Θ)

Angle of dip which the roughing tool sets when dipping to depth (P).

Number of finishing passes in Z (N)

Finishing setting (δ)

Side thickness to be left when roughing

Finishing setting in Z (δz)

Height to be left when roughing

Feed rate in Z (Fz)

**Cycle description
roughing**

- 1 The tool travels in the spindle axis to the safety level (Zs) and to the start position.
- 2 Then the tool moves at feed rate (Fz) to the first defined depth (l) and cuts out the pocket from the inside out, moving backwards and forwards using the programmed rough feed rate for that level. The tool moves each time by the roughing setting (Δ) until the finishing setting (δ) remains at the outer and inner shape edges.
The setting (l) is applied moving back and forwards along a sloping track using the angle of dip for roughing (β).
- 3 After which the tool travels away from the shape back to the starting point in the working plane and the set level (l).
- 4 This process (2 to 3) is repeated until the programmed roughing depth ($P-\delta z$) is reached.

Finishing depth

- 5 The tool travels in the spindle axis to the safety level (Zs) and to the middle of the pocket.
- 6 The tool then travels at high speed to position ($P-2*\delta z$). The tool travels back and forwards, using the angle of dip for finishing (Θ) to depth(P). The tool cuts out the pocket from the inside out, moving backwards and forwards using the feed rate for the level. The tool moves each time by the roughing setting (Δ) until the finishing setting (δ) remains at the pocket and island edges.
- 7 The tool moves in the spindle axis to the safety level (Zs).

Finishing sidea

- 8 The tool travels to the middle of the pocket.
- 9 Then the tool travels at feed rate (Fz) to depth (P) and finishes first the island and then the rim using the programmed feed rate.
- 10 Finally the tool is moved back at high speed to the safety level (Zs).

CONTOUR MILLING

starting point X

X	286.236	F	0.00
Y	113.000	S	0
Z	212.150	T	0
		D	1

parameters

X	0.000	Y	0.000
Zs	0.000	Z	0.000
P	0.000	I	0.000

contour

1:contour

F1 Previous variant
F2 Next variant
F4 Insert points
F5 Geometry
F6 Technology
F7 Cancel
F8 Capture

Contour milling

selected shape

Geometry

Note:
Select a start point outside the shape (before the first point of the shape).

Co-ordinates (X, Y)

Co-ordinates of the start position

Safety axial position in Z (Zs)

Co-ordinate values of the workpiece in Z (Z)

Depth (P)

Setting in Z (I)

Shape



The tool travels from the start point first in Z and then in XY to the first point of the shape.



The tool travels from the starting point first in in XY and then in Z to the first point of the shape.



Continue by entering all the required technology data (tool number, direction of rotation, feed, spindle rotation speed).

CONTOUR MILLING

number of the tool to be used

X	286.236	F	0.00
Y	113.000	S	0
Z	212.150	T	0
		D	1

roughing

T D

F S

finishing

T D

F S

δ

general

Fz

F1 Previous variant
F2 Next variant
F4 Tool table
F5 Geometry
F6 Technology
F7 Cancel
F8 Capture

Finishing setting (δ)

Side thickness to be left when roughing

Feed rate in Z (Fz)

Tool radius compensation:

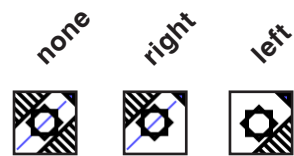

Cycle description**roughing**

- 1 The tool travels in the spindle axis to the safety level (Zs) and to the start point (X, Z).
- 2 Then the tool moves using the feed (Fz) first in Z and then in XY to the first point of the shape, or – if selected – first in XY and then in Z to the first point of the shape. At the same time the first depth setting (I) is set, the finishing setting (δ) is applied and the shape is cut out. If selected, the tool radius compensation is applied.
- 3 After which the tool travels away from the shape back to the starting point in the working plane and the set level (I).
- 4 This process (2 to 3) is repeated, until the programmed depth (P) is reached.

finishing

- 5 The tool travels in the spindle axis to the safety level (Zs) and to the start point (X, Z).
- 6 Then the tool moves using the feed (Fz) first in Z and then in XY to the first point of the shape, or - if selected - first in XY and then in Z to the first point of the shape. At the same time depth (P) is set. If selected, the tool radius compensation is applied.
- 7 Finally the tool is moved back at high speed to the safety level (Zs).

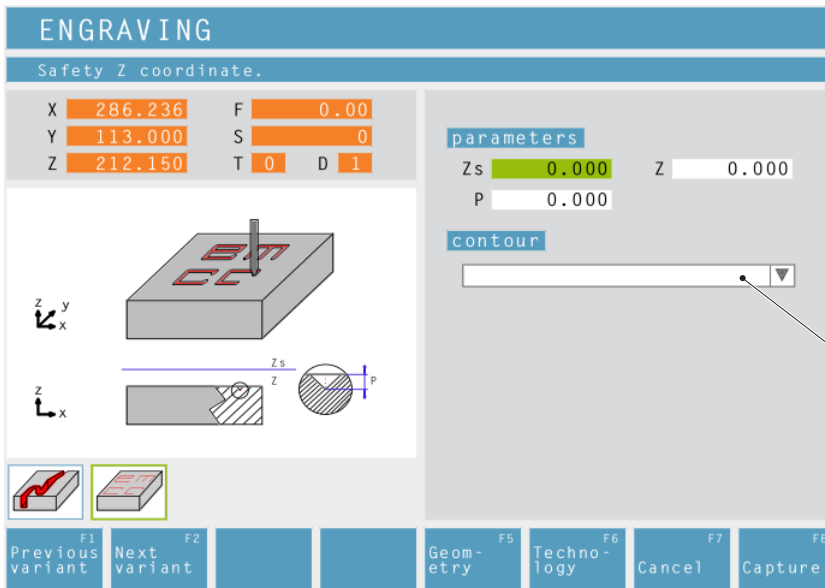

Engraving



Selection of the cycle from the cycle group using the softkeys "Previous variant F1" and "Next variant F2".

Selected contour



Safety axis position in Z (Zs)

Coordinate value of the workpiece in Z (Z)

Depth (P)

Contour

Select a previously defined contour from the selection list.

Note:
Select a starting point outside the contour (before the first contour point).



Also enter all other required technology data (tool number, direction of rotation, feed, spindle speed).

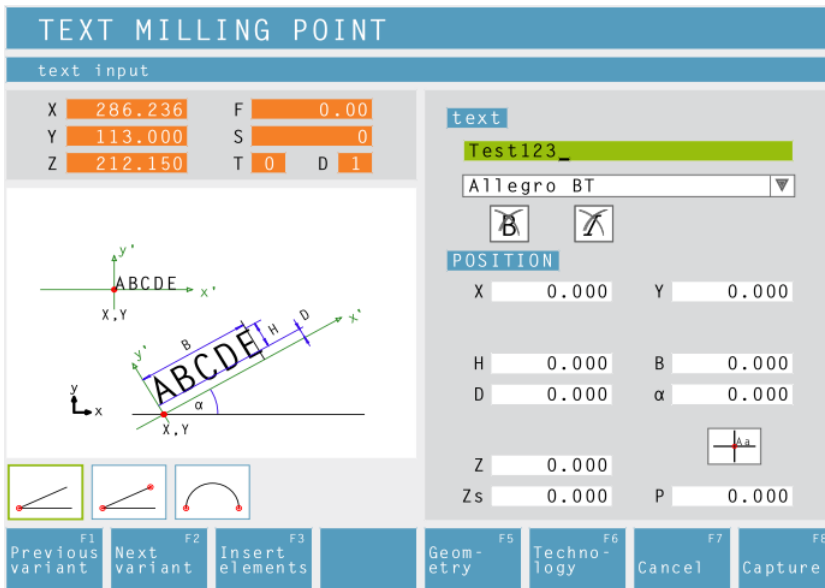

Text milling point



Selection of the cycle from the cycle group by means of the soft keys "Prior variant F1" and "Next variant F2".



Text input

Enter a single-line text with a maximum of 25 characters.

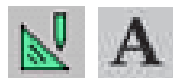

Font

Select the fonts for text milling that are defined in the CAD mode.

Coordinates (X, Y)

Coordinates of the starting point

Text height (H)

Text width (B)

Distance to x' axis (D)

Rotation angle by anchor point (α)

Position of the text:

Alignment of the text (see input graphic)

Starting height (Z)

Safety axis position in Z (Zs)

Depth (P)

Position of the text:

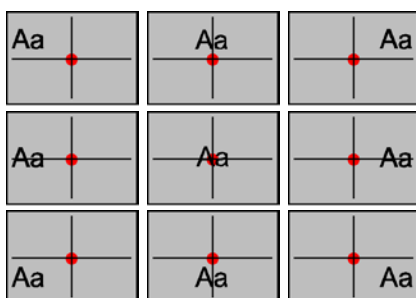

Feed rate in Z (Fz)

Coolant

turning the coolant on / off

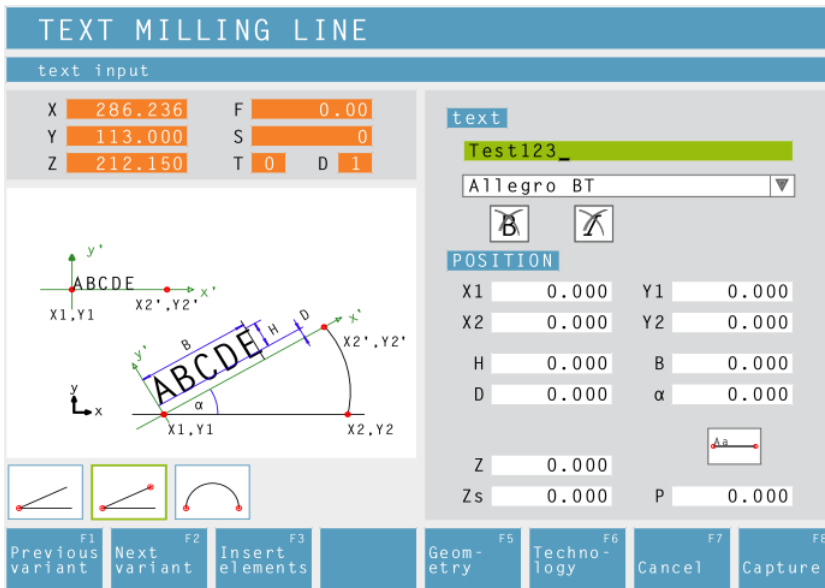

Text milling line



Selection of the cycle from the cycle group by means of the soft keys "Prior variant F1" and "Next variant F2".



Text input

Enter a single-line text with a maximum of 25 characters.

Font

Select font and font size

Coordinates (X1, Y1)

Coordinates of the starting point

Coordinates (X2, Y2)

Coordinates of the end point

Text height (H)

Text width (B)

Distance to x' axis (D)

Rotation angle by anchor point (α)

Starting height (Z)

Safety axis position in Z (Zs)

Depth (P)

Position of the text:

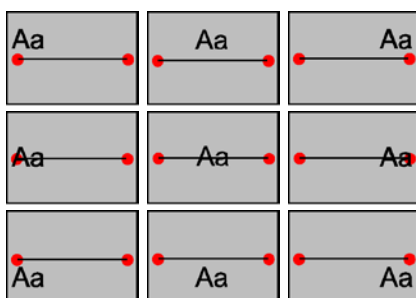

Feed rate in Z (Fz)

Coolant

turning the coolant on / off

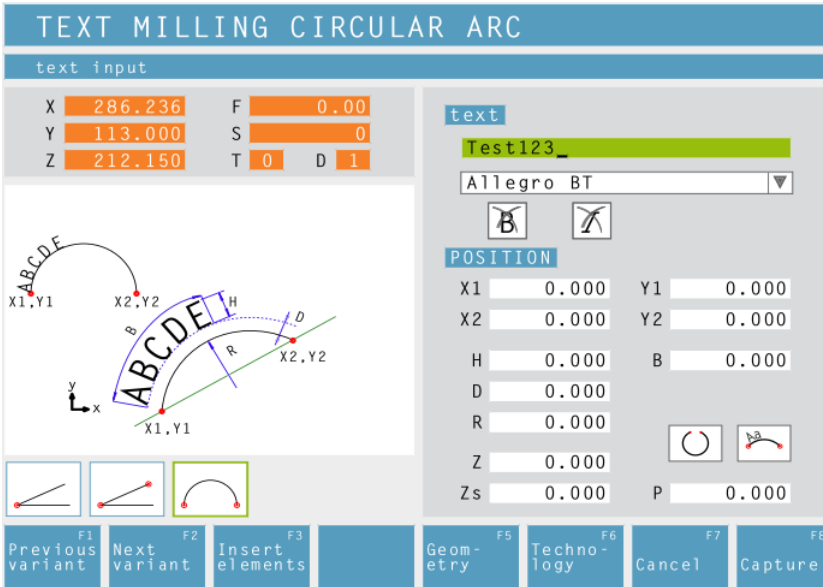

Text milling circular arc



Selection of the cycle from the cycle group by means of the soft keys "Prior variant F1" and "Next variant F2".



Text input

Enter a single-line text with a maximum of 25 characters.

Font

Select font and font size.

Coordinates (X1, Y1)

Coordinates of the starting point

Coordinates (X2, Y2)

Coordinates of the end point

Text height (H)

Text width (B)

Distance to x' axis (D)

Radius of the circle (R)

Rotation angle by anchor point (α)

Starting height (Z)

Safety axis position in Z (Zs)

Depth (P)

Arc type:

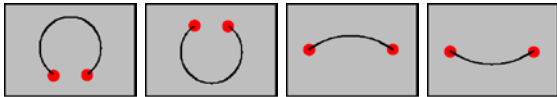

Position of the text:

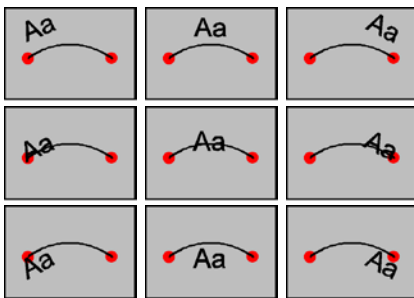

Feed rate in Z (Fz)

Coolant

turning the coolant on / off



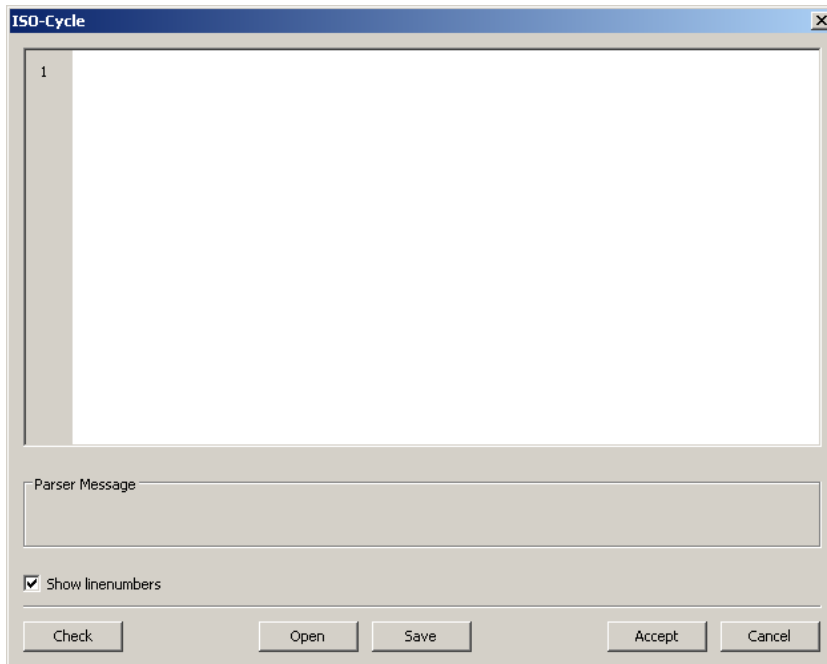

ISO cycle

This cycle is designed for restricted DIN/ISO code programming.

You can check syntax using the "check" button.

"Foreign" ISO codes can be incorporated using the "Open" button. The "Save" button is used for securing and storing the ISO code in the desired folder. The "Takeover" button is used for taking over the ISO code into the cycle list.

Overview of M-commands

COMMAND	MEANING
M0	Programmed stop
M1	Optional stop
M2	Program end
M3	Spindle ON, clockwise
M4	Spindle ON, anti-clockwise
M5	Spindle OFF
M6	Tool change
M7	Minimal lubrication ON
M8	Coolant ON
M9	Coolant OFF, minimal lubrication OFF
M10	Spindle brake ON
M11	Spindle brake OFF
M25	OPEN clamping device
M26	CLOSE clamping device
M27	Swivel partial apparatus
M30	Main program end
M70	Position position-controlled spindle
M71	Blow out ON
M72	Blow out OFF

Overview of G-commands

COMMAND	MEANING	FORMAT
G0	Rapid feed	G0 X... Y... Z...
G1	Linear interpolation	G1 X... Y... Z...
G2	Circular interpolation, clockwise	G2 X... Y... Z... I... J... K... G2 X... Y... Z... R...
G3	Circular interpolation, anti-clockwise	G3 X... Y... Z... I... J... K... G3 X... Y... Z... R...
G4	Dwell time (in seconds)	G4 F...
G33	Thread cutting	G33 X... Y... Z... L-pitch
G40	Deselection of tool radius correction	G40
G41	Tool radius correction, left	G41
G42	Tool radius correction, right	G42
G60	Precision stop	G60
G64	Path control mode	G64
G94	Feed rate per minute	G94
G95	Feed rate per revolution	G95
G96	Constant cutting speed	G96
G97	Constant speed	G97

I, J, K Circle centre point in Cartesian coordinates, in relation to the starting point.

R=+ Angle less than or equal to 180°.

R=- Angle greater than 180°.

Other commands

COMMAND	MEANING	FORMAT
T	Tool selection	T...
D	Cutting edge selection	D...
S	Spindle speed or constant cutting speed	S...
F	Feed rate	F...

Coordinate transformation

The cycle group "coordinates transformation" is used for zero point offset (NPV) of the zero point of the workpiece (W). The following options exist:

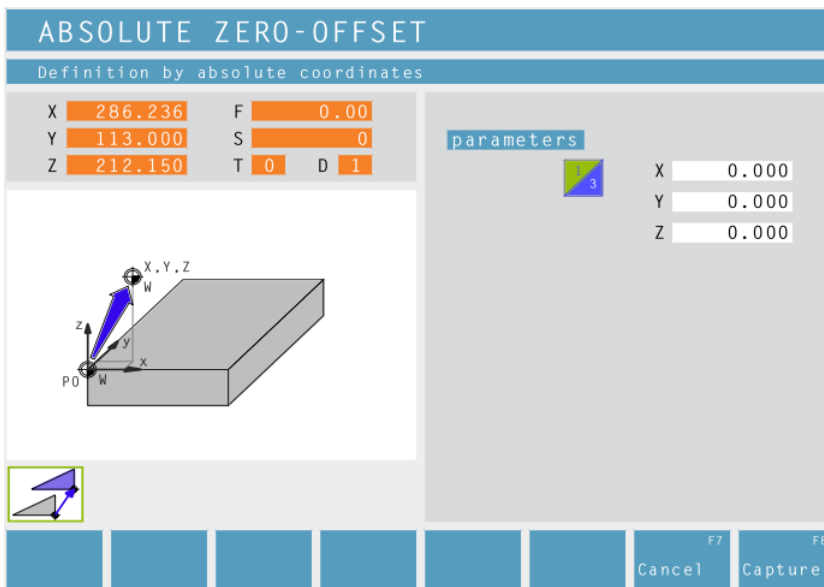

Absolute zero-offset



Coordinates (X, Y, Z)
Absolute offset of the workpiece null-point (W):

- X...absolute NPV on the X-Axis
- X...absolute NPV on the Y-Axis
- X...absolute NPV on the Z-Axis

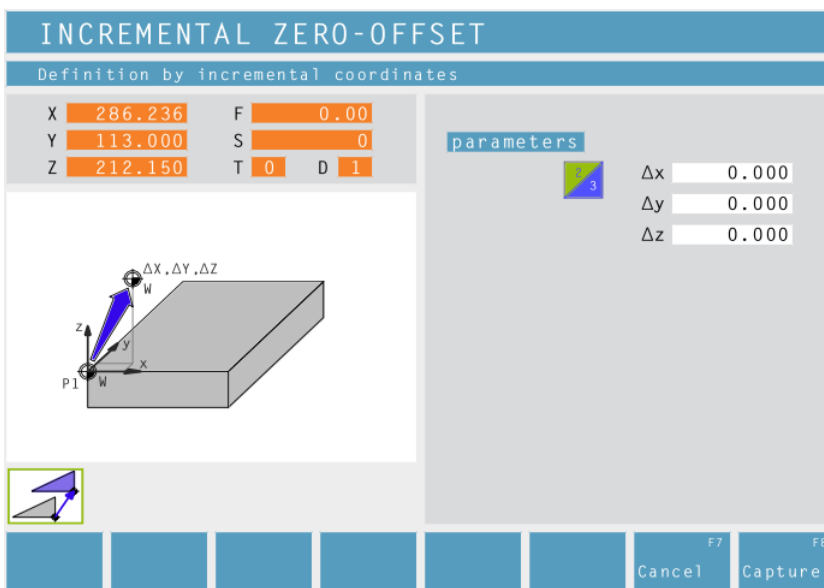

Incremental zero-offset



Coordinates (Δx , Δy , Δz)
Incremental offset of the workpiece null-point (W):

- Δx ...incremental NPV on the X-Axis
- X...incremental NPV on the Y-Axis
- X...incremental NPV on the Z-Axis

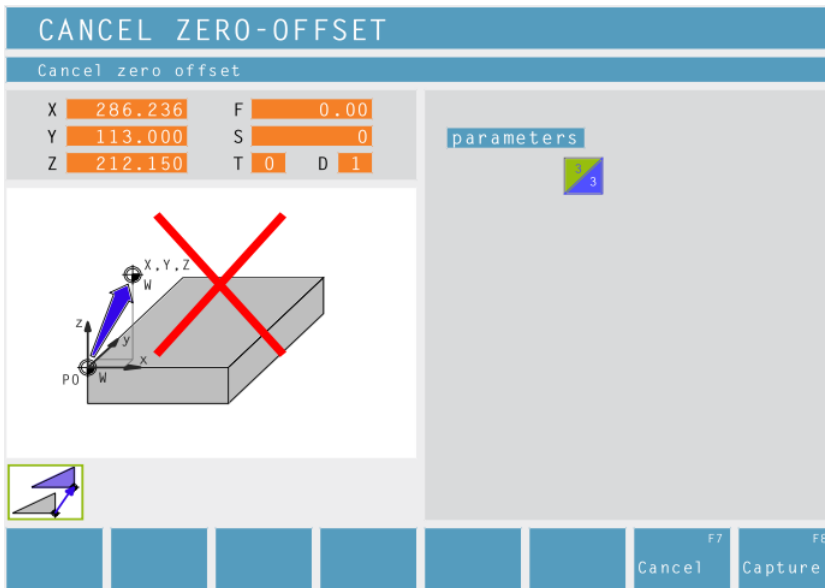

Cancel Zero-offset



The offset of the workpiece zero point (W) is cancelled.

Notice:
 For production of separate pieces the "Set reference point" option is usually used (see Chapter F Setting a reference point).

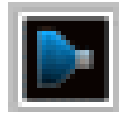

Simulation

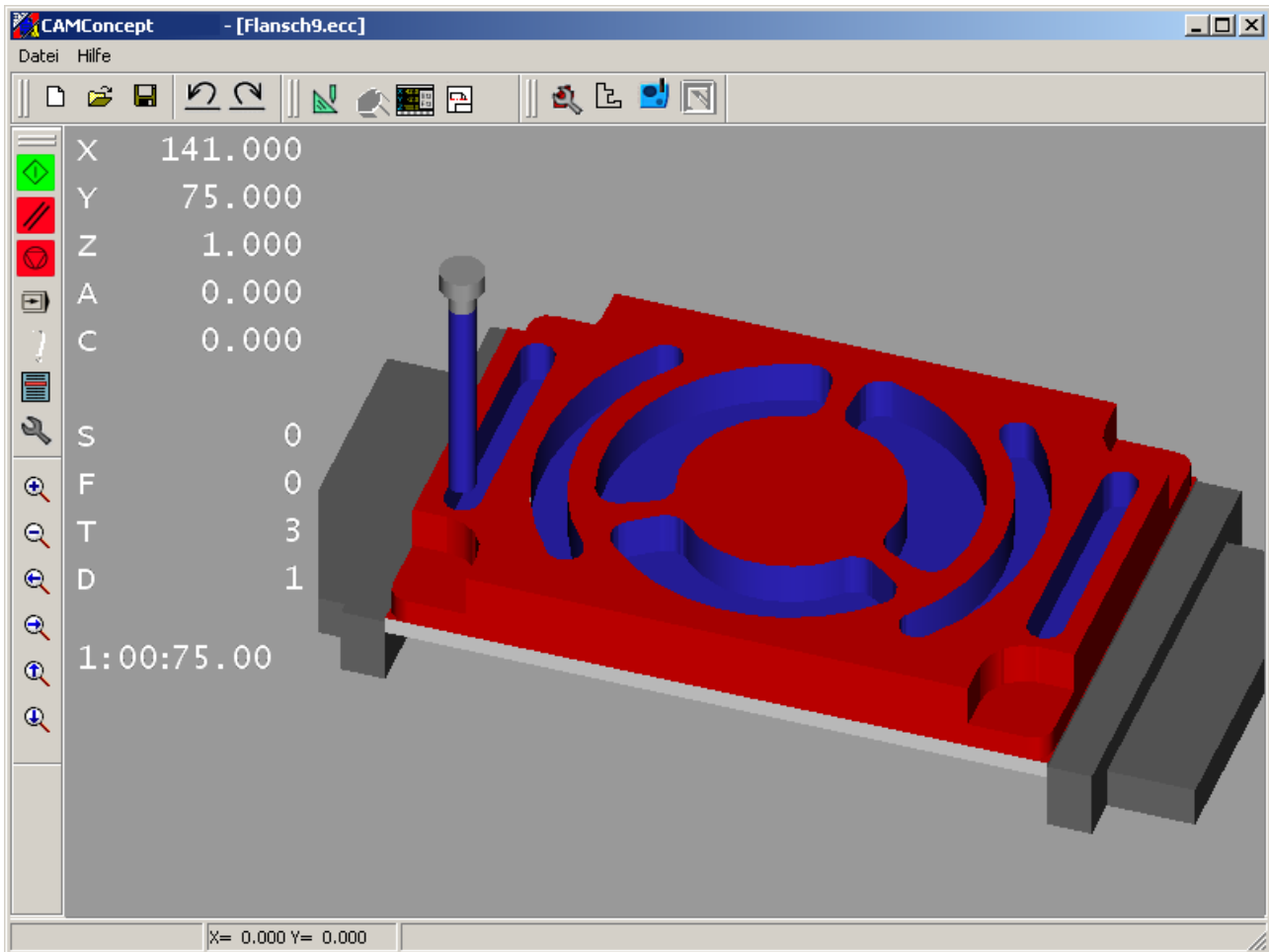

CAM concept simulation window

The simulation window shows the machining of the workpiece.

Note:

You can modify existing tools and create new tools by means of the 3D ToolGenerator (see chapter 3D ToolGenerator).



Besides the simulation window, the current feed rates, spindle speeds, names and position values of the tool are displayed.

The machining time is displayed in hours: minutes: seconds.centiseconds.

Error messages are also displayed here, e.g. danger of collision.



Simulation NC start

The simulation is started with this symbol. A CAMConcept project must be open in order to be able to start the simulation. The file name of the CAMConcept project being open at the moment is displayed in the upper center of the simulation window (e.g.: flange9.ecc).



Simulation NC reset

With this symbol the simulation and the CNC program are aborted and they return to their initial state.



Simulation NC stop

With this symbol the simulation and the CNC program are stopped. The simulation can be continued by means of the symbol "NC start".



Simulation single block on/off

This symbol enables to stop the simulation after every block. The simulation can be continued by means of the symbol "NC start".

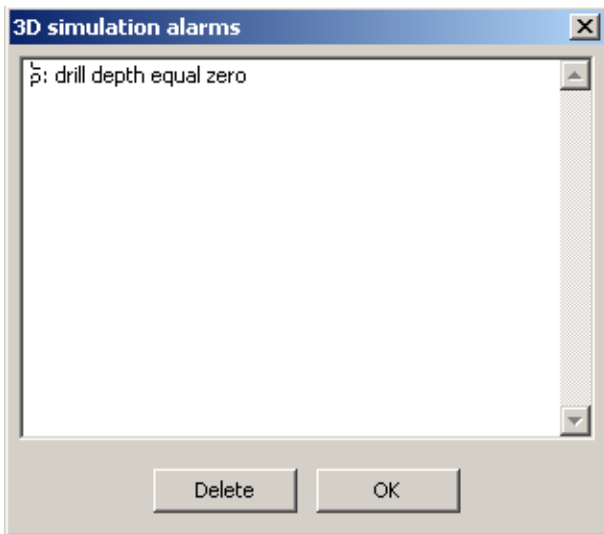

Alarms of the 3D simulation

This symbol signalizes that CAMConcept has detected one or several errors in the 3D simulation.

Press the symbol and the alarm window will be opened. The alarm messages are listed in the alarm window.

With "Delete" alarms are acknowledged and deleted.

With "OK" alarms are confirmed and remain in the alarm list.

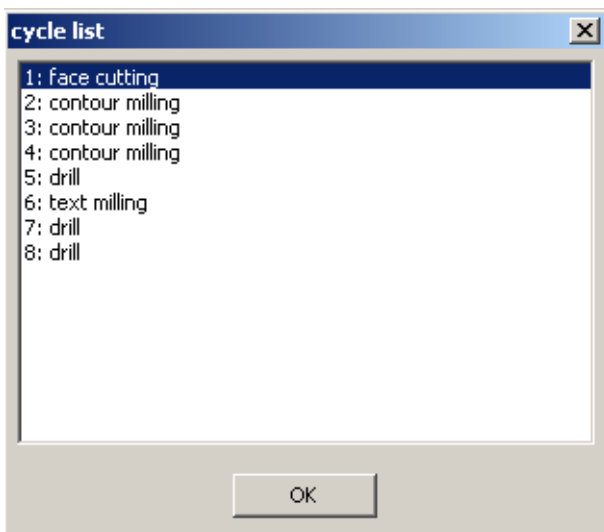

Cycle lists

After having selected the symbol, the window "cycle list" will appear. It displays all defined cycles of a project. The cycle being machined at the moment is displayed with a frame.



3D-simulation settings

After having selected the symbol, the window for the simulation properties will appear.

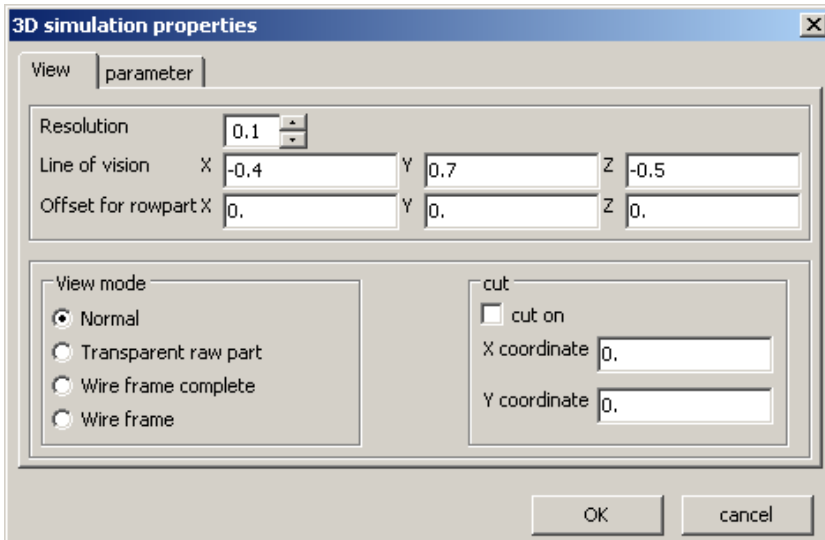

You can define the following settings in the register card "View".

Global resolution:

You can enter values from 0.01 to 0.3. The higher the resolution, the more precise is the structure of the 3D image.

Viewing direction:

With the viewing direction the initial view on the unmachined part can be pre-set. However, the viewing direction can always be changed during simulation by means of the mouse as well.

Type of display:

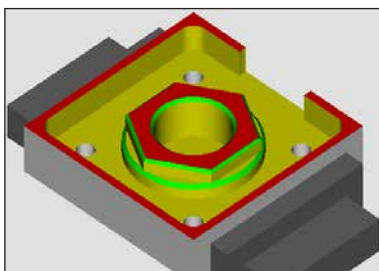

- Normal display

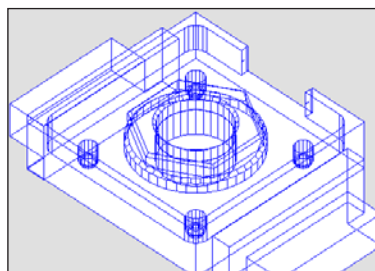

- Wire frame complete

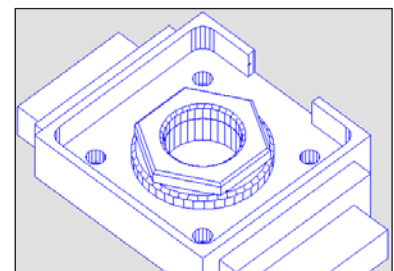

- Wire frame

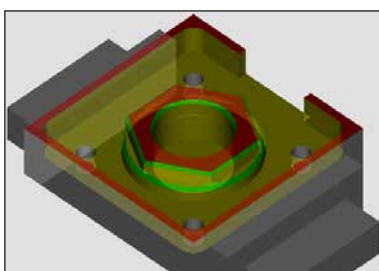

- Unmachined part, transparent

Section:

The section view enables the observation of normally hidden sequences.

The position of the cut surface is defined by the input of the coordinates. For the display of the section view the simulation has to be started again.

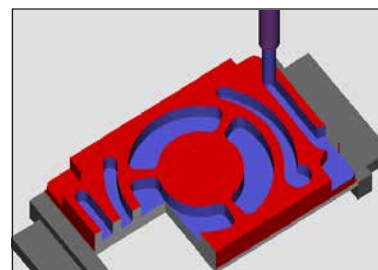

Section view

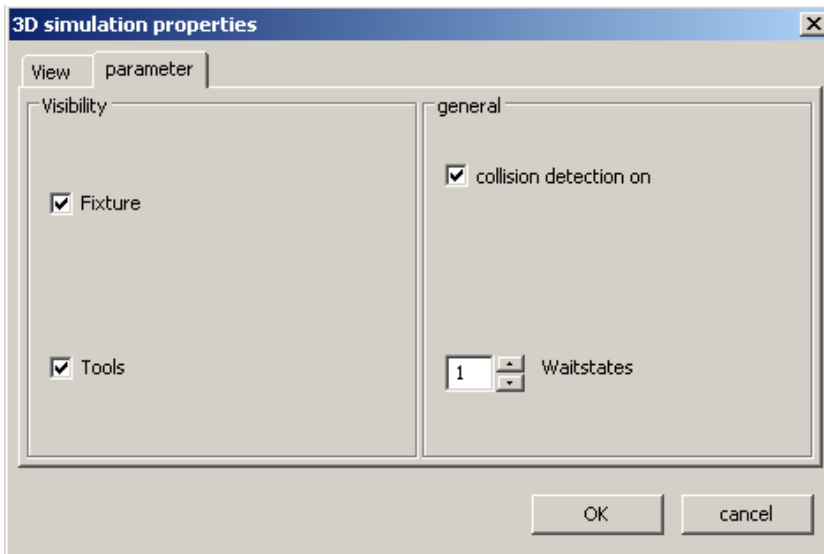

You can define the following settings in the register card "Parameter":

Visibility:

- clamping device
visible/ invisible
- tools
visible/ invisible

General:

- collision detection on/off
- waiting cycles
0-99

Collision detection:

During collision detection the following situations are monitored:

- Contacts between tool and clamping device.
When the display of the clamping device is switched off, collisions of clamping devices are not monitored.
- Contacts of non-cutting tool parts with the workpiece or the clamping device.

In case of a collision the collision type will be displayed and the simulation will be aborted.

Waiting cycles

The simulation can be slowed down by means of waiting cycles. A waiting cycle is the freely definable time that has to pass between two tool movements. The waiting cycle is defined in values between 0 and 99.

The higher the value of the waiting cycle, the longer lasts the simulation.

Zoom commands for the simulation

The navigation bar enables to zoom and shift the simulation image.



Zoom in

After the symbol has been selected, the view is zoomed in by one step.



Zoom out

After the symbol has been selected, the view is zoomed out by one step.



To zoom the simulation image in or out in an infinitely variable way, press "Ctrl" + the left mouse button + mouse movement upwards or downwards.



Shift

After selection of the symbol the view is shifted step by step.

Press the right mouse button + mouse movement in the required direction to shift the simulation image in an infinitely variable way.

Rotate

At any time you can rotate the simulation image in one plane as required by pressing and holding the left mouse button. For movements around the Z axis press "Shift" + left mouse button + mouse movement to the right or to the left.





Tool modelling with the 3D-Tool Generator

With the 3D-ToolGenerator you can modify existing tools and create new tools.

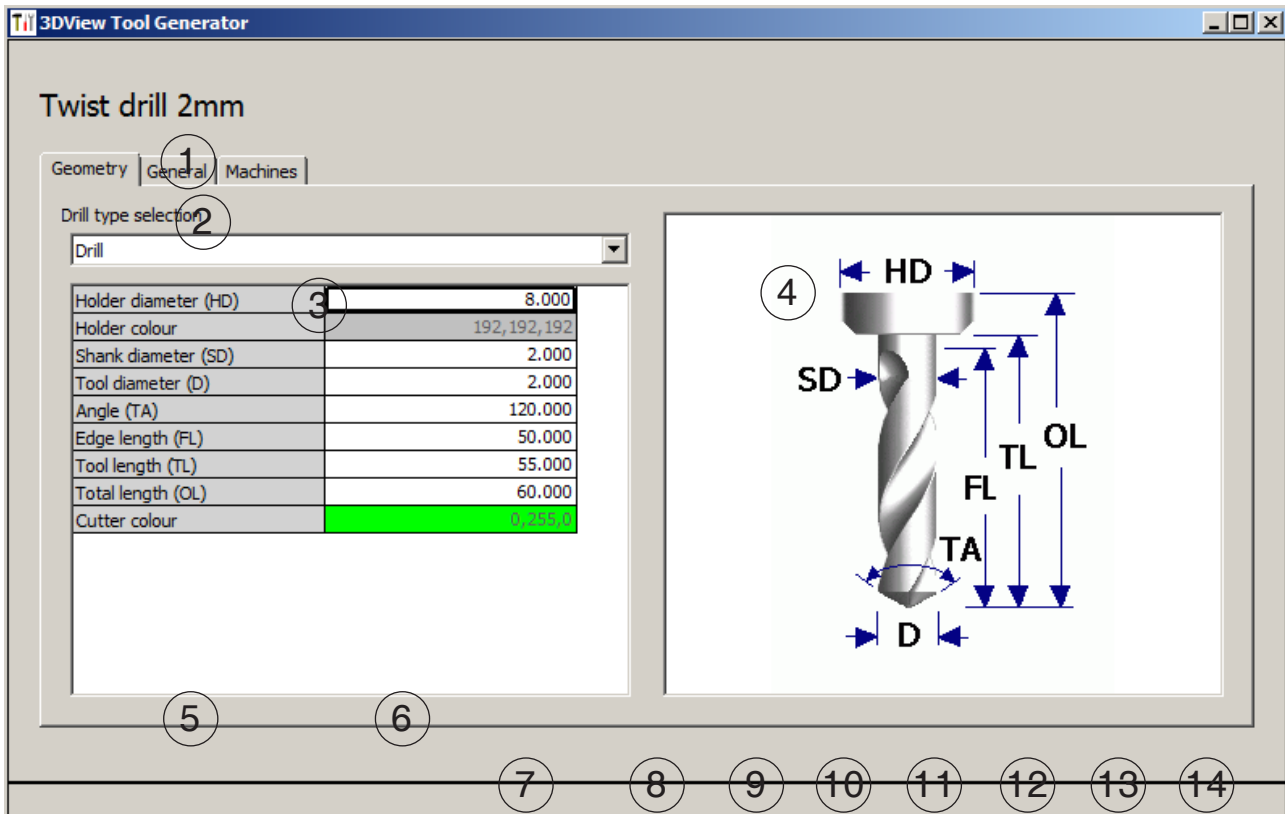

1 Register cards for "Geometry", "General" and "Machines" for drilling and milling tools and "Tip", "Holder", "General" and "Machines" for turning tools.

2 Selection of tool types

3 This window enables the input of tool dimensions.

4 Graphical support for the tool dimensioning

5 Choice of tools for the selected tool type

6 Choice of tool types (here: only drill)

"Turning tool", "Milling tool" and "Drilling tool"

reduce the tool choice to the respective type (here: only drilling tools are listed).

"All" does not reduce the tool choice.

7 Buttons for quickly browsing through the tools

go to first tool in the group

go to last tool in the group

go forward in the list by one tool

go back in the list by one tool

8 Button to delete tools

9 Button to create new tools

10 Button to copy tools

11 Button to save changes

12 Button for 3D visualization

13 Button to sort tools

14 Button to terminate the 3DView tool generator

Generating a new tool

- Set the selection for tool types to "Selection all".
- Press the button to generate new tools.
- Select the tool name, the tool type and the measurement system.

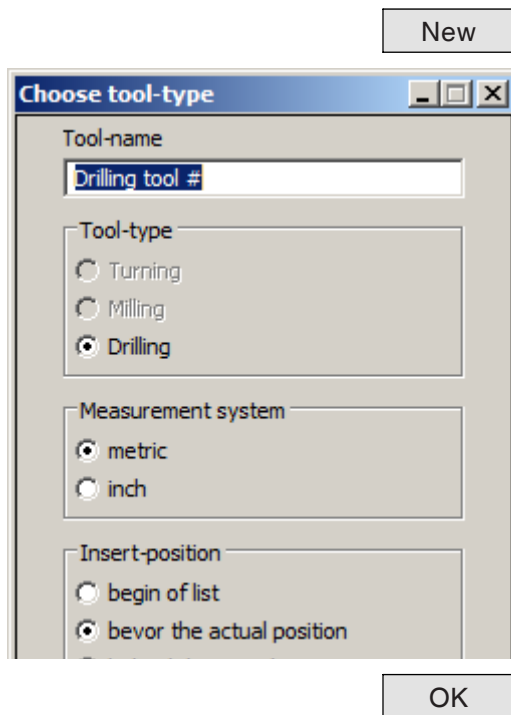

- Confirm the entries with "OK".

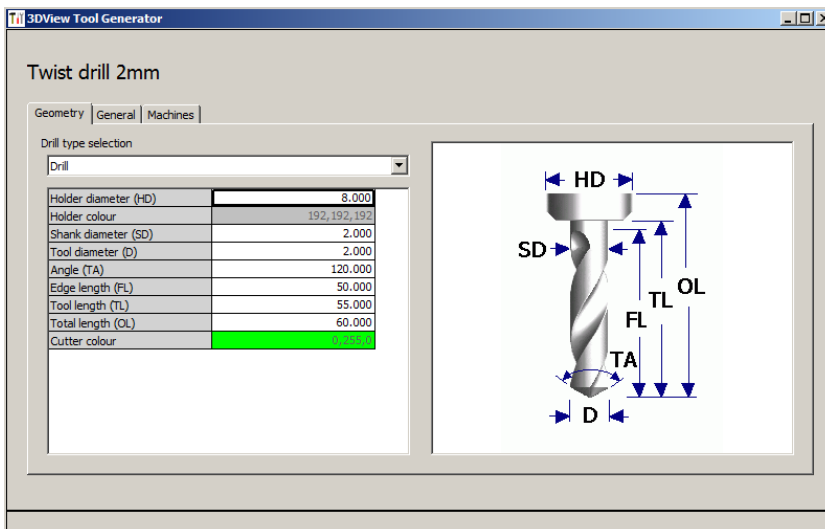

- Define all tool dimensions.
- Define all tool colours (see "select tool colour").



- Confirm the entries with "Store".

Copying a tool

- Call the tool you wish to copy.
- Press the button to copy tools.
- Enter the new tool name.
- Confirm the inputs with "Save".



Changing an existing tool

- Call the tool you wish to change.
- Change the values.
- Confirm the entries with "Store".

Store

Selecting a tool colour

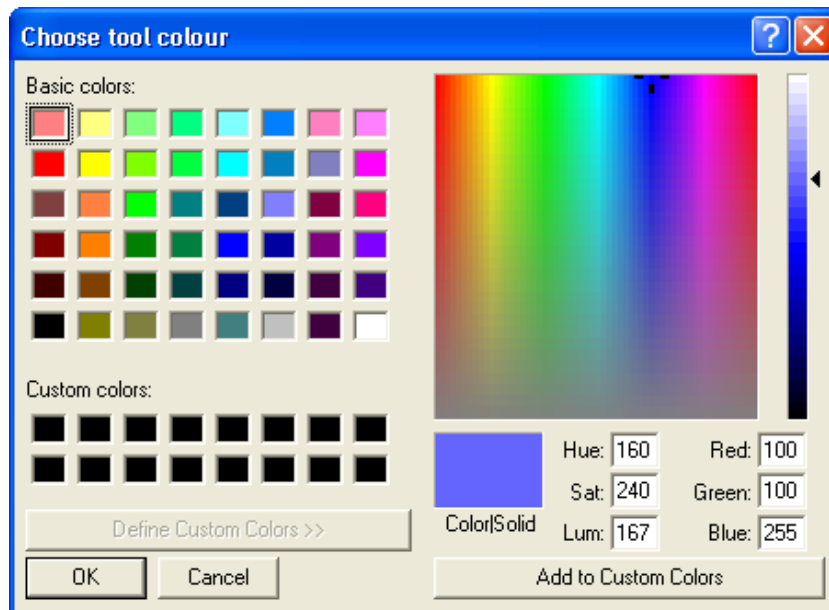

- Make a double click with the mouse pointer in the coloured box of the tool colour. The window "Select tool colour" will appear.
- Select the required colour.

OK

- Confirm the entries with "OK".

Visualizing a tool

- Press the button for 3D visualization.

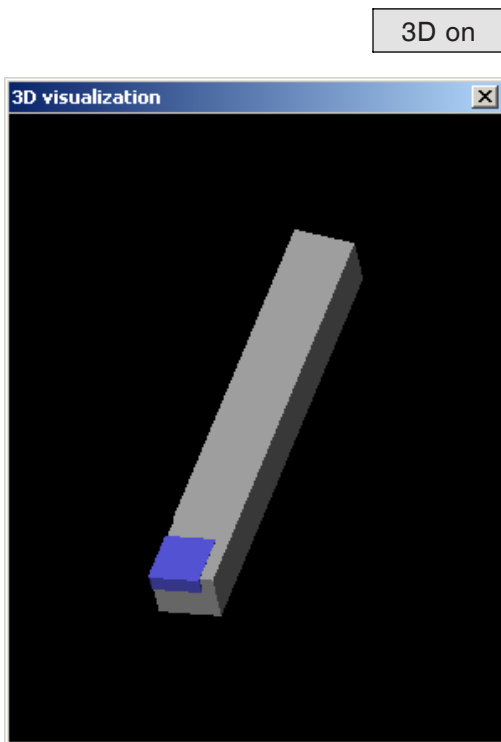

3D on

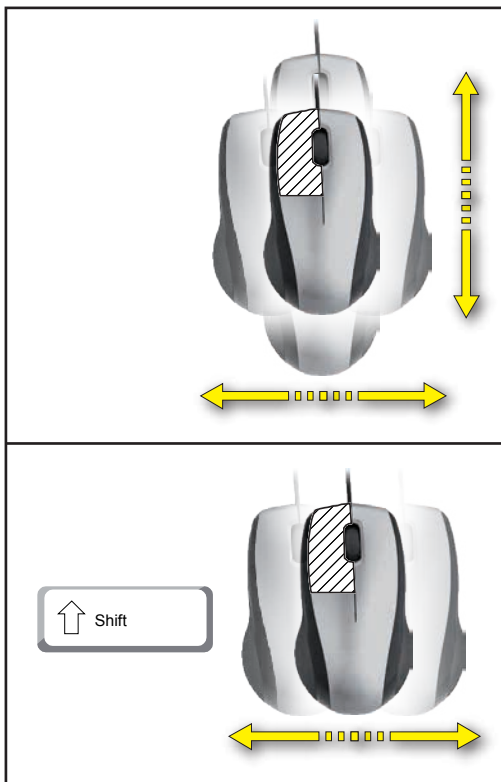

Rotating image

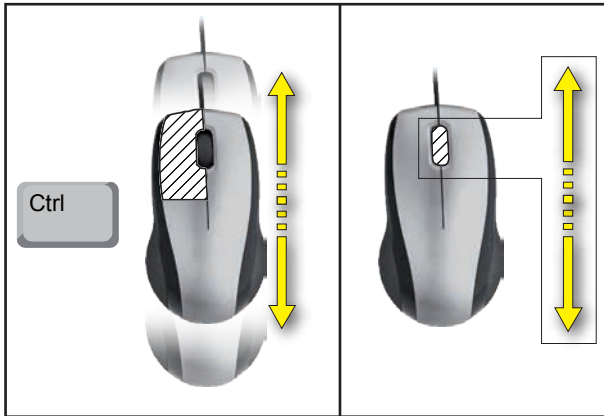

Zooming

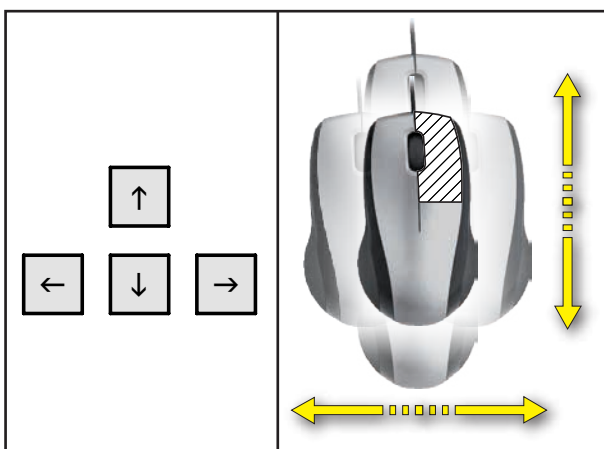

Shifting

Sorting function

The sorting sequence makes it possible to display the tools being sorted according to tool types. Every time the sorting sequence is changed, the selection for tools will be updated.



- Press the button for sorting.

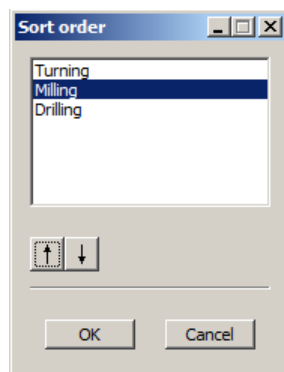

- Define new sorting sequence.



- Confirm the entries with "OK".

F: NC commands

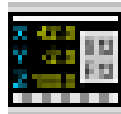

NC mode

By clicking on the "NC" switchover icon all of the NC command icons are activated. The NC mode remains active until it is deselected with CAD, CAM or AV.

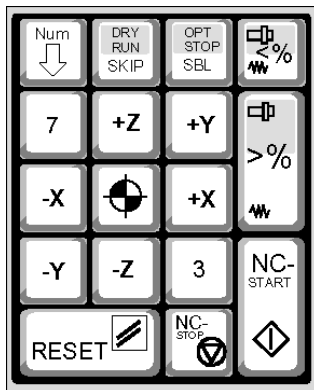

The machine functions in the numerical keypad are only active if NUM Lock is not enabled. You can use both the CAMConcept icons and the keys on the numerical keypad to select functions.

Key functions in the numerical keypad



Only for programming workstations: Settings for the numeric keypad in EMConfig

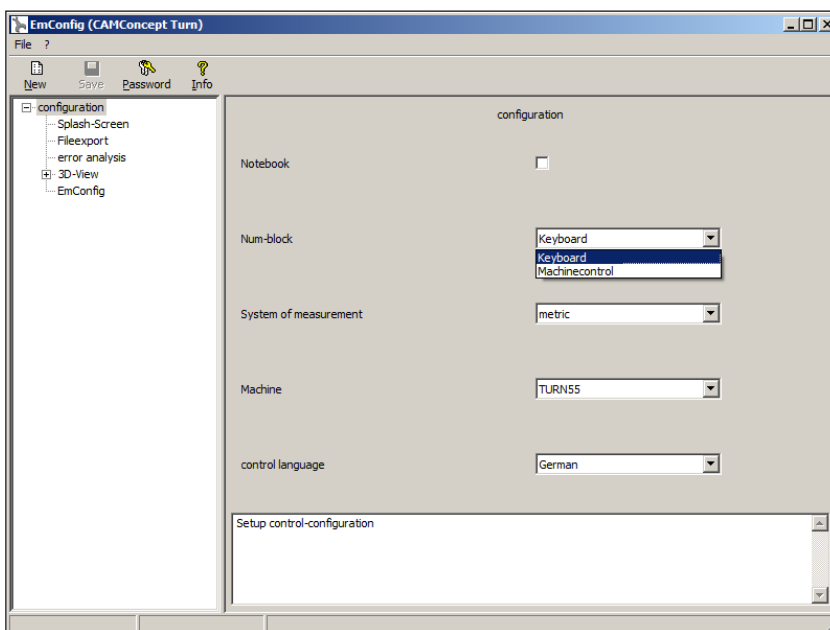

Keyboard

Windows standard functionality for whole numeric keypad.

Machinecontrol

Enables Num-Lock to switch between keyboard and machinefunction on digit keys.

Settings for the numeric keypad

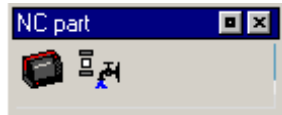

NC part



Working through the NC program

Screen layout for an NC part

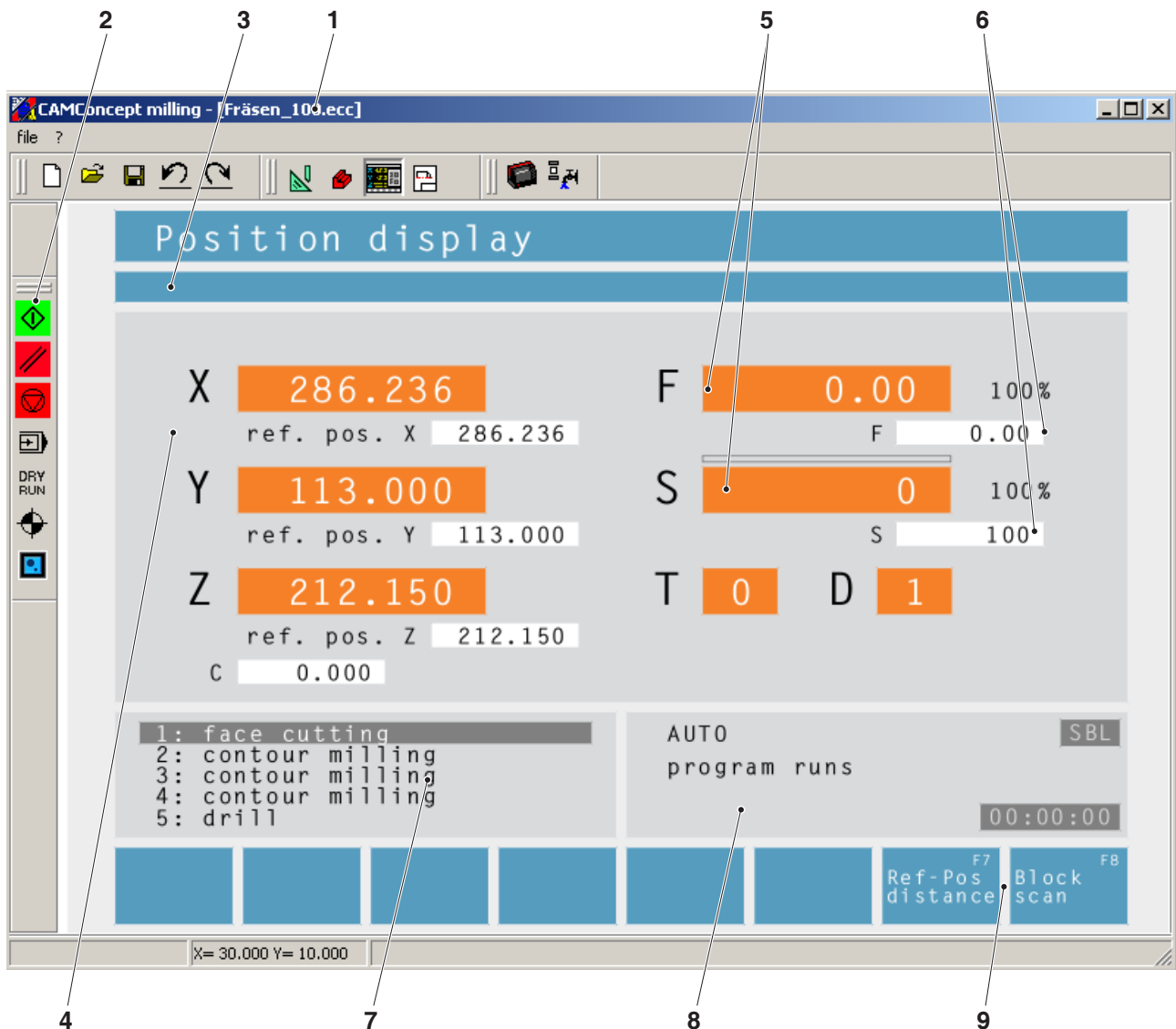

- 1 Project name
- 2 Commands for program processing
- 3 Alarm and message line
- 4 NC position displays; technology data
- 5 Display for the current value of feed rate or spindle speed
- 6 Display for the programmed value of feed rate or spindle speed
- 7 Cycle list
The defined cycles of a project are displayed. The cycle being machined at the moment is displayed in a shaded frame.
- 8 Status display; display of the operating modes
- 9 Soft keys to switch between the reference position display and the path-to-go display or to set the block scan



NC start

Select this symbol to switch from the "JOG" mode to the "AUTO" operating mode and to start the NC program run.

A CAMConcept project must be open in order to be able to start the NC program run. The file name of the CAMConcept project being open at the moment is displayed in the top center of the simulation window (e.g. flange9.ecc).



NC reset

Select this symbol to switch from the "AUTO" mode to the "JOG" operating mode, to abort the NC program run and to return to the initial state.



NC stop

Select this symbol to stop the NC program run. The simulation can be continued with the symbol "NC start".

Before continuing the simulation you can carry out various modifications (e.g. with the peripheral commands).



Single block on/off

Select this symbol to stop the NC program run after every block. The NC program run can be continued again by means of the symbol "NC start".

When the single block is activated, the text "SBL" (=SingleBlock) will be displayed in the simulation window.



Dryrun

Select this symbol to activate the status test run. When the NC program is started, the main spindle will not be switched on and the slides will move at a fix feed rate.

Always carry out the test run without a workpiece.

When the test run is activated, the text "DRY" will be displayed in the simulation window.



Reference the machine

Activate this symbol to traverse the reference point of the machine.

Command advance

With the "Command advance" function, cycles can be skipped when running the program.

Skipping cycles with the "Command advance" function

- Press the softkey.

Command
advance

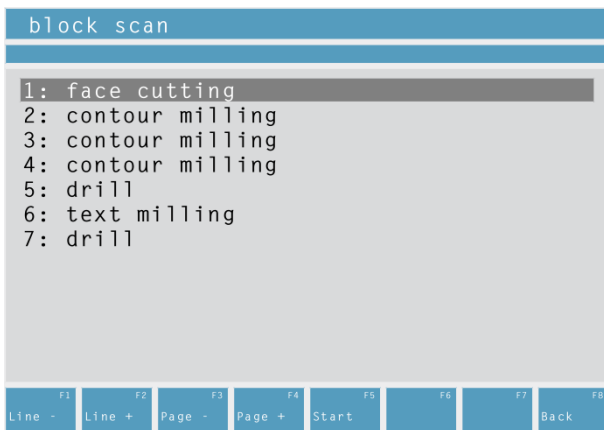

- Use the cursor keys to select the cycle at which you wish the NC program to resume.

Comm. adv.
Start

- Press the softkey. Wait until CAMConcept has calculated the remaining program. Do not press "NC-Start" until CAMConcept asks you to do so in the status bar. The skipped cycles are not executed.

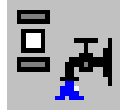

Periphery

Peripheral functions enable to switch the required NC machine accessories.

The scope of the peripheral functions displayed depends on the installation. Functions that are not available are displayed with a grey frame.



Spindle counter-clockwise

Select this symbol to switch the main spindle on in counter-clockwise direction.



Spindle stop

Select this symbol to turn the main spindle off.



Spindle clockwise

Select this symbol to switch the main spindle on in clockwise direction.

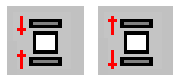

Open / close clamping device

Select this symbol to open or close the clamping device.

Mind that the clamping device can only be switched when the door is open.



Blowing-out device on / off

With this symbol the blowing-out device will be switched on for 3 seconds.

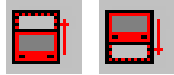

Automatic door open / close

With this symbol the machine door will be opened or closed.

Mind that the clamping device can only be switched when the door is open.



Coolant on / off

With this symbol the cooling pump will be switched on and off.



Next tool

This icon is used to advance the tool drum by 1 tool. This function can also be performed by pressing the key combination ALT + K.

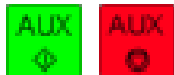

Auxiliary drives on / off

Select this symbol to switch the auxiliary drives on or off.

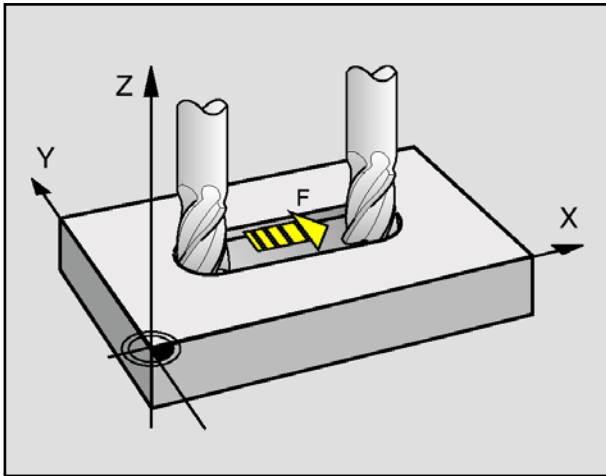

Feed rate F [mm/min]

The feed rate F is the speed in mm/min (feet/min) at which the centre of the tool moves on its path. The maximum feed rate can vary for each of the machine axes and is defined by machine parameters.

Input

- Use the key to select the feed rate input field.
- Enter the required feed rate.
- Press the "Enter" key. The desired value is automatically entered in the display for the programmed value.

Rapid feed

For the rapid feed enter F99999. When the data are adopted (by pressing "Enter") the value is then corrected to the rapid feed rate of the current machine.

Feed control

The feed rate value F you have programmed corresponds to 100%. With the aid of these buttons or with the "Feed override" function you can change the set feed rate F by a percentage factor.

Adjustment range:

0% to 120% of the programmed feed rate.

Only the changed percentage – but not the resulting effective value – is displayed.

A level of 100% cannot be exceeded in rapid feed.

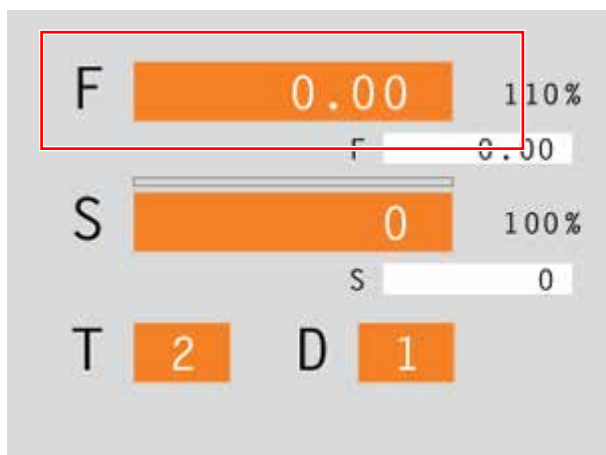

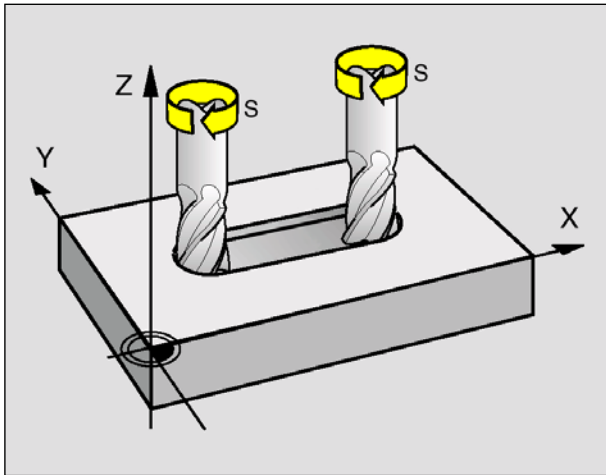

Spindle speed S [rpm]

The spindle speed S is entered as revolutions-per-minute (rpm).

Input

- Use the key to select the spindle speed input field.
- Enter the desired speed.
- Press the "Enter" key. The desired value is automatically entered in the display for the programmed value.

Spindle speed correction

The spindle speed S you have programmed corresponds to 100%. With the aid of these key combinations or the "Spindle speed override" function you can change the set spindle speed S by a percentage factor.

Adjustment range:

50% to 120% of the programmed spindle speed.

Only the changed percentage – but not the resulting effective value – is displayed.

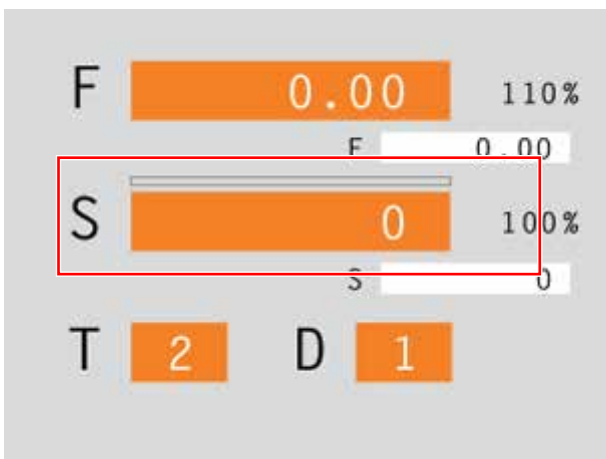



20



3



2

**Note:**

With the cutting edge number 0 no tool movement is provided.

Traversing coordinate axes

Example: Traverse the X-axis to position 20

- Use the key to select the input field for the axis which is to be traversed.
- Enter the required coordinate value.
- Press the softkey to traverse the axis at the set feed rate.

Setting / resetting a reference point**Setting a reference point**

- Use the key to select the input field for the desired axis.
- Enter the required reference value.
- Press the "Enter" key.
- CAMConcept opens a dialog box. Press "Enter" to confirm this query.

Resetting a reference point

- Use the key to select the input field for the desired axis.
- Press the softkey to reset a previously set reference point to the zero point of the machine.

Loading a new tool

Example: Select tool 3 with cutting edge 2

- Use the key to select the tool number input field.
- Enter the number of the required tool (3).
- Press "Enter" to load the tool.
- Use the key to select the cutting edge number input field.
- Enter the number of the required cutting edge (2).
- Press "Enter" so that CAMConcept registers the chosen cutting edge 2.

G: Operations scheduling

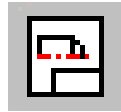

Operations scheduling mode

The AV (= operations scheduling) command symbols are activated by clicking on the shift symbol "AV".

The operations scheduling mode will remain active until it is deselected with CAD, CAM or NC.

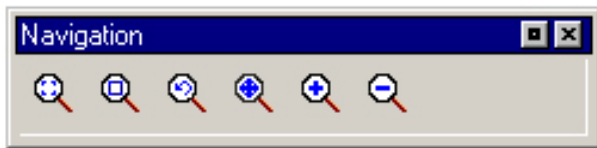

The zoom commands are described in chapter B.

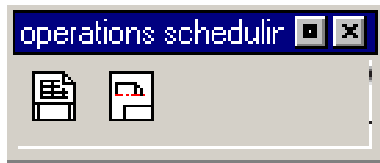

Operations scheduling



Print tool table

After having selected the symbol, you can define the entries for the text field in the input window.

date:	name:	description:
06/17/09	Mr. Clark	plate

Input window for the text field



Print plans

After having selected the symbol, you can specify the print area with the mouse. In the input window you can edit the engineering drawing block and also set the scale.

date:	name:	description:
06/17/09	Mr. Clark	plate

Input window print plans



Plane setting

After having selected the symbol, you can make the planes either visible or invisible by switching in the select window.

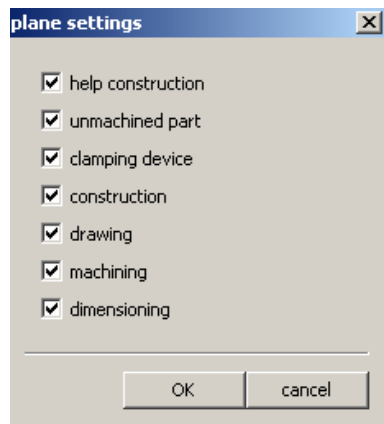

Level settings window

H: Alarms and Messages

Machine Alarms 6000 - 7999

These alarms will be triggered by the machines. There are different alarms for the different machines. The alarms 6000 - 6999 normally must be confirmed with RESET. The alarms 7000 - 7999 are messages which normally will disappear when the releasing situation is finished.

PC MILL 50 / 55 / 100 / 105 / 125 / 155 Concept MILL 55 / 105 / 155

6000: EMERGENCY OFF

The EMERGENCY OFF key was pressed. Remove the endangering situation and restart machine and software.

6001: PLC-CYCLE TIME EXCEEDING

Contact EMCO Service.

6002: PLC - NO PROGRAM CHARGED

Contact EMCO Service.

6003: PLC - NO DATA UNIT

Contact EMCO Service.

6004: PLC - RAM MEMORY FAILURE

Contact EMCO Service.

6005: OVERHEAT BRAKEMODUL

Main drive was braked too often, large changes of speed within a short time. E4.2 active

6006: OVERLOAD BRAKE RESISTOR

see 6005

6007: SAFETY CIRCUIT FAULT

Axis and main drive contactor with machine switched off not disabled. Contactor got stuck or contact error. E4.7 was not active during switch-on.

6008:MISSING CAN SUBSCRIBER

Check fuses or EMCO customer service.
Contact EMCO Service.

6009: SAFETY CIRCUIT FAULT

A running CNC program will be interrupted, the auxiliary drives will be stopped, the reference position will be lost.

6010: DRIVE X-AXIS NOT READY

The step motor board is defective or too hot, a fuse or cabling is defective.

A running program will be stopped, the auxiliary drives will be switched off, the reference position will be lost.

Check fuses or contact EMCO service.

6011: DRIVE Y-AXIS NOT READY

see alarm 6010.

6012: DRIVE Z-AXIS NOT READY

see alarm 6010.

6013: MAIN DRIVE NOT READY

Main drive power supply defective, main drive too hot, fuse defective.

A running program will be stopped, the auxiliary drives will be switched off.

Check fuses or contact EMCO Service.

6014: NO MAIN SPINDLE SPEED

This will be released, when the spindle speed is lower than 20 rpm because of overload.

Alter cutting data (feed, infeed, spindle speed).

The CNC program will be aborted, the auxiliary drives will be stopped.

6019: VICE TIME EXCEED

The electric vice has not reached a stop position within 30 seconds.

The control or the clamping device board are defective, the vice is stuck. Adjust the proximity switches of the stop position.

6020: VICE FAILURE

When the electric vice is closed, the signal "clamping device clamped" of the clamping device board has failed.

The control, the clamping device board or the wiring are defective.

K 2017-07

6022: CLAMPING DEVICE BOARD DEFECTIVE

The signal "clamping device clamped" is constantly released, although no command has been given.

Replace the board.

6024: MACHINE DOOR OPEN

The door was opened while a machine movement. The program will be aborted.

6027: DOOR LIMIT SWITCH DEFECTIVE

The limit switch of the automatic door is displaced, defective, wrong cabled.

Contact EMCO service.

6028: DOOR TIMEOUT

The automatic door sticks, the pressured air supply is insufficient, the limit switch is displaced. Check door, pressured air supply, limit switch or contact EMCO service.

6030: NO PART CLAMPED

No workpiece inserted, vice cheek displaced, control cam displaced, hardware defective.

Adjust or contact EMCO service.

6040: TOOL TURRET INDEX FAILURE

After WZW procedure drum pressed down by Z-axis. Spindle position wrong or mechanical defect. E4.3=0 in lower state

6041: TOOL CHANGE TIMEOUT

Tool drum sticks (collision?), main drive not ready, fuse defective, hardware defective.

A running CNC program will be stopped.

Check for collisions, check fuses or contact EMCO service.

6043-6046: TOOL DISK POSITION FAULT

Position error of main drive, error of position supervising (inductive proximity switch defective or disadjusted, drum allowance), fuse defective, hardware defective.

The Z axis could have been slipped out of the tothing while the machine was switched off.

A running CNC program will be stopped.

Contact EMCO service.

6047: TOOL DISK UNLOCKED

Tool drum turned out of locked position, inductive proximity switch defective or disadjusted, fuse defective, hardware defective.

A running CNC program will be interrupted.

Contact EMCO service.

When the tool drum is turned out of locked position (no defect), act as following:

Turn the drum into locking position manually

Change into MANUAL (JOG) mode.

Turn the key switch. Traverse the Z slide upwards, until the alarm disappears.

6048: DIVIDING TIME EXCEEDED

Dividing head sticks, insufficient pressured air supply, hardware defective.

Check for collision, check pressured air supply or contact EMCO service.

6049: INTERLOCKING TIME EXCEEDED

see alarm 6048

6050: M25 AT RUNNING MAIN SPINDLE

Cause: Programming mistake in NC program.

A running program will be aborted.

The auxilliary drives will be switched off.

Remedy: Correct NC program

6064: DOOR AUTOMATIC NOT READY

Cause: pressure failure automatic door
automatic door sticks mechanically
limit switch for open end position defective
security print circuits defect
cabling defective
fuses defective

A running program will be aborted.

The auxilliary drives will be switched off.

Remedy: service automatic door

6069: CLAMPING FOR TANI NOT OPEN

When opening the clamping pressure switch does not fall within 400ms. Pressure switch defective or mechanical problem. E22.3

6070: PRESSURE SWITCH FOR TANI MISSING

When closing the clamping pressure switch does not respond. No compressed air or mechanical problem. E22.3

6071: DIVIDING DEVICE NOT READY

Servo Ready Signal from frequency converter missing. Excess temperature drive TANI or frequency converter not ready for operation.

6072: VICE NOT READY

Attempt to start the spindle with an open vice or without clamped workpiece.

Vice sticks mechanically, insufficient compressed air supply, compressed air switch defective, fuse defective, hardware defective.

Check the fuses or contact EMCO service.

6073: DIVIDING DEVICE NOT READY

Cause: locking switch defective
cabling defective
fuses defective

A running program will be aborted.

The auxiliary drives will be switched off.

Remedy: service automatic dividing device
lock the dividing device

6074: DIVIDING TIME EXCEEDED

Cause: dividing device sticks mechanically
locking switch defective
cabling defective
fuses defective
insufficient compressed-air supply.

A running program will be aborted.

The auxiliary drives will be switched off.

Remedy: Check for collision, check the compressed-air supply or contact the EMCO service.

6075: M27 AT RUNNING MAIN SPINDLE

Cause: Programming mistake in NC program.

A running program will be aborted.

The auxiliary drives will be switched off.

Remedy: Correct NC program

6110: 5TH AXIS NOT CONNECTED

Cause: 4th/5th axis was selected in EMConfig, but not connected electrically.

Remedy: Connect 4th/5th axis or deselect in EM-Config.

6111: 5TH AXIS CONNECTED

Cause: 4th/5th axis was deselected in EMConfig, but is electrically connected.

Remedy: Remove 4th/5th axis from machine or select in EMConfig.

6112: MOTOR PROTECTION RELEASED

Cause: A motor protection switch has triggered. A possibly active NC program is stopped immediately.

Remedy: Check the device connected to the motor protection switch and switch on again. If recurring, contact EMCO service department.

7000: INVALID TOOL NUMBER PROGRAMMED

The tool position was programmed larger than 10. The CNC program will be stopped.

Interrupt program with RESET and correct the program.

7001: NO M6 PROGRAMMED

For an automatic tool change you also have to program a M6 after the T word.

7007: FEED STOP!

The axes have been stopped by the robotics interface (robotics entry FEEDHOLD).

7016: SWITCH ON AUXILIARY DRIVES

The auxiliary drives are off. Press the AUX ON key for at least 0.5 sec. (to avoid accidentally switching on) to switch on the auxiliary drives.

7017: REFERENCE MACHINE

Approach the reference point.

When the reference point is not active, manual movements are possible only with key switch at position "setting operation".

7018: TURN KEY SWITCH

With NC-Start the key switch was in position "setting operation".

NC-Start is locked.

Turn the key switch in the position "automatic" to run a program.

7020: SPECIAL OPERATION MODE ACTIVE

Special operation mode: The machine door is opened, the auxiliary drives are switched on, the key switch is in position "setting operation" and the consent key is pressed.

Manual traversing the axes is possible with open door. Swivelling the tool turret is not possible with open door. Running a CNC program is possible only with standing spindle (DRYRUN) and SINGLE block operation.

For safety: If the consent key is pressed for more than 40 sec. the function of this key is interrupted, the consent key must be released and pressed again.

7021: INITIALIZE TOOL TURRET

The tool turret operating was interrupted.

No traversing operation is possible.

Press tool turret key in JOG operation. Message occurs after alarm 6040.

7022: INITIALIZE TOOL TURRET!

see 7021

7023: WAITING TIME MAIN DRIVE!

The LENZE frequency converter has to be separated from the mains supply for at least 20 seconds before you are allowed to switch it on again. This message will appear when the door is quickly opened/ closed (under 20 seconds).

7038: LUBRICATION SYSTEM FAULT

The pressure switch is defective or gagged.

NC-Start is locked. This can be reset only by switching off and on the machine.

Contact EMCO service.

7039: LUBRICATION SYSTEM FAULT

Not enough lubricant, the pressure switch is defective.

NC-Start is locked.

Check the lubricant and lubricate manually or contact EMCO service.

7040: MACHINE DOOR OPEN

The main drive can not be switched on and NC-Start can not be activated (except special operation mode)

Close the machine to run a program.

7042: INITIALIZE MACHINE DOOR

Every movement and NC-Start are locked.

Open and close the machine door to initialize the safety circuits.

7043: PIECE COUNT REACHED

A predetermined number of program runs was reached. NC-Start is locked. Reset the counter to continue.

7050: NO PART CLAMPED

After switching on or after an the vice is neither at the open position nor at the closed position. NC-Start is locked.

Traverse the vice manually on a valid end position.

7051: DIVIDING HEAD NOT LOCKED!

Either the dividing head is in an undefined position after the machine has been switched on, or the locking signal after a dividing process is missing.

Initiate the dividing process, check, respectively adjust the proximity switch for locking.

7054: VICE OPEN

Cause: the workpiece is not clamped

When switching on the main spindle with M3/M4 alarm 6072 (vice not ready) will be released.

Remedy: Clamp

7055: OPEN TOOL CLAMPING SYSTEM

A tool is clamped in the main spindle and the control does not recognize the corresponding T number.

Eject the tool from the main spindle when the door is open by means of the PC keys "Strg" and " 1 ".

7056: SETTING DATA INCORRECT

An invalid tool number is stored in the setting data.

Delete the setting data in the machine directory xxxxx.pls.

7057: TOOLHOLDER OCCUPIED

The clamped tool cannot be positioned in the tool turret since the position is occupied.

Eject the tool from the main spindle when the door is open by means of the PC keys "Strg" and " 1 ".

7058: RETRACTING THE AXES

The position of the tool turret arm cannot be clearly defined during the tool change.

Open the machine door, push the tool turret magazine backwards to the stop. Move the milling head in the JOG mode upwards to the Z reference switch and then traverse the reference point.

7087: MOTOR PROTECTION HYDRAULIC CLAMPING RELEASED!

Hydraulic motor is defective, stiff, circuit breaker is set incorrectly.

Replace motor or check circuit breaker and replace if necessary.

7090: ELECTRICAL CABINET OVERRIDE SWITCH ACTIVE

The cabinet door can only be opened when the key switch is switched on without raising an alarm.

Switch off key switch.

7107: MOTOR PROTECTION RELEASED

A motor protection switch has triggered. A possibly running NC program will be completed. A new NC start will be prevented.

Check the device connected to the motor protection switch and switch on again. If recurring, contact EMCO service department.

7270: OFFSET COMPENSATION ACTIVE !

Only with PC-MILL 105

Offset compensation activated by the following operation sequence.

- Reference point not active
- Machine in reference mode
- Key switch in manual operation
- Press STRG (or CTRL) and simultaneously 4

This must be carried out if prior to the tool change procedure spindle positioning is not completed (tolerance window too large)

7271: COMPENSATION FINISHED, DATA SAVED !

see 7270

PC TURN 50 / 55 / 105 / 120 / 125 / 155
Concept TURN 55 / 60 / 105 / 155 /
250 / 260 / 460
Concept MILL 250
EMCOMAT E160
EMCOMAT E200
EMCOMILL C40
EMCOMAT FB-450 / FB-600

6000: EMERGENCY OFF

The EMERGENCY OFF key was pressed.
 The reference position will be lost, the auxiliary drives will be switched off.
 Remove the endangering situation and restart machine and software.

6001: PLC-CYCLE TIME EXCEEDING

The auxiliary drives will be switched off.
 Contact EMCO Service.

6002: PLC - NO PROGRAM CHARGED

The auxiliary drives will be switched off.
 Contact EMCO Service.

6003: PLC - NO DATA UNIT

The auxiliary drives will be switched off.
 Contact EMCO Service.

6004: PLC - RAM MEMORY FAILURE

The auxiliary drives will be switched off.
 Contact EMCO Service.

6005: K2 OR K3 NOT DE-ENERGIZED

Turn machine on/off. Defective security board.

6006 EMERGENCY-OFF RELAY K1 NOT DE-ENERGIZED

Turn machine on/off. Defective security board.

6007 SAFETY CIRCUIT FAULT**6008: MISSING CAN SUBSCRIBER**

The PLC-CAN board is not identified by the control.
 Check the interface cable and the power supply of the CAN board.

6009: SAFETY CIRCUIT FAULT**6010: DRIVE X-AXIS NOT READY**

The step motor board is defective or too hot, a fuse is defective, over- or undervoltage from mains.

A running program will be stopped, the auxiliary drives will be switched off, the reference position will be lost.

Check fuses or contact EMCO service.

6011: DRIVE Z-AXIS NOT READY

see 6010.

6012: DRIVE Z-AXIS NOT READY

see 6010.

6013: MAIN DRIVE NOT READY

Main drive power supply defective or main drive too hot, fuse defective, over- or undervoltage from mains.

A running program will be stopped, the auxiliary drives will be switched off.

Check fuses or contact EMCO Service.

6014: NO MAIN SPINDLE SPEED

This alarm will be released, when the spindle speed is lower than 20 rpm because of overload. Alter cutting data (feed, infeed, spindle speed).

The CNC program will be aborted, the auxiliary drives will be switched off.

6015: NO DRIVEN TOOL SPINDLE SPEED

see 6014.

6016: AUTOMATIC TOOL TURRET SIGNAL COUPLED MISSING**6017: AUTOMATIC TOOL TURRET SIGNAL UNCOUPLED MISSING**

In the tool turret that can be coupled, the position of the coupling and uncoupling magnet is monitored by means of two proximity switches. It has to be made sure that the coupling is in the rear stop position so that the tool turret can get to the next tool position. Equally, during operation with driven tools the coupling has to be safe in the front stop position.

Check and adjust the cables, the magnet and the stop position proximity switches.

6018: AS SIGNALS, K4 OR K5 NOT DE-ENERGIZED

Turn machine on/off. Defective security board.

6019: POWER SUPPLY MODULE NOT READY

Turn machine on/off. Power supply module, defective axis controller 6020 AWZ drive failure turn machine on/off, defective axis controller.

6020: DRIVEN TOOL DRIVE MALFUNCTION

The driven tool power supply defective or the driven tool drive is too hot, fuse defective, mains overvoltage or undervoltage. A running CNC program will be aborted, the auxiliary drives will be stopped. Check the fuses or contact EMCO service.

6021: COLLET TIME OUT

During closing of the clamping device the pressure switch has not reacted within one second.

6022: CLAMPING DEVICE BOARD DEFECTIVE

The signal "clamping device clamped" is constantly released, even though no command has been given. Replace the board.

6023: COLLET PRESSURE MONITORING

The pressure switch turns off when the clamping device is closed (compressed air failure for more than 500ms).

6024: MACHINE DOOR OPEN

The door was opened while a machine movement. The program will be aborted.

6025: GEARBOX COVER NOT CLOSED

The gearbox cover was opened while a machine movement. A running CNC program will be aborted. Close the cover to continue.

6026: MOTOR PROTECTION COOLANT PUMP RELEASED

6027: DOOR LIMIT SWITCH DEFECTIVE

The limit switch of the automatic door is displaced, defective, wrong cabled. Contact EMCO service.

6028: DOOR TIMEOUT

The automatic door sticks, the pressured air supply is insufficient, the limit switch is displaced. Check door, pressured air supply, limit switch or contact EMCO service.

6029: TAILSTOCK QUILL TIME EXCEED

The tailstock quill does not reach a final position within 10 seconds.

Adjust the control and the stop position proximity switches, or the tailstock quill is stuck.

6030: NO PART CLAMPED

No workpiece inserted, vice cheek displaced, control cam displaced, hardware defective. Adjust or contact EMCO service.

6031: QUILL FAILURE

6032: TOOL CHANGE TIMEOUT

see alarm 6041.

6033: TOOL TURRET SYNC ERROR

Hardware defective. Contact EMCO service.

6037: CHUCK TIMEOUT

The pressure switch does not react within one second when the clamping device is closed.

6039: CHUCK PRESSURE FAILURE

The pressure switch turns off when the clamping device is closed (compressed air failure for more than 500ms).

6040: TOOL TURRET INDEX FAILURE

The tool turret is in no locked position, tool turret sensor board defective, cabling defective, fuse defective.

A running CNC program will be stopped. Swivel the tool turret with the tool turret key, check fuses or contact EMCO service.

6041: TOOL CHANGE TIMEOUT

Tool drum sticks (collision?), fuse defective, hardware defective.

A running CNC program will be stopped. Check for collisions, check fuses or contact EMCO service.

6042: TOOL TURRET OVERHEAT

Tool turret motor too hot. With the tool turret a max. of 14 swivel procedures a minute may be carried out.

6043: TOOL CHANGE TIMEOUT

Tool drum sticks (collision?), fuse defective, hardware defective.

A running CNC program will be stopped. Check for collisions, check fuses or contact EMCO service.

6044: BRAKING RESISTANCE - MAIN DRIVE OVERLOADED

Reduce number of speed changes in the program.

6045: TOOL TURRET SYNC MISSING

Hardware defective.
Contact EMCO service.

6046: TOOL TURRET ENCODER FAULT

Fuse defective, hardware defective.
Check fuses or contact EMCO service.

6048: CHUCK NOT READY

Attempt to start the spindle with open chuck or without clamped workpiece.
Chuck sticks mechanically, insufficient pressured air supply, fuse defective, hardware defective.
Check fuses or contact EMCO service.

6049: COLLET NOT READY

see 6048

6050: M25 DURING SPINDLE ROTATION

With M25 the main spindle must stand still (consider run-out time, evtl. program a dwell)

6055: NO PART CLAMPED

This alarm occurs when with rotating spindle the clamping device or the tailstock reach the end position. The workpiece has been pushed out of the chuck or has been pushed into the chuck by the tailstock. Check clamping device settings, clamping forces, alter cutting data.

6056: QUILL NOT READY

Attempt to start the spindle or to move an axis or to swivel the tool turret with undefined tailstock position.
Tailstock is locked mechanically (collision), insufficient pressured air supply, fuse defective, magnetic switch defective.
Check for collisions, check fuses or contact EMCO service.

6057: M20/M21 DURING SPINDLE ROTATION

With M20/M21 the main spindle must stand still (consider run-out time, evtl. program a dwell)

6058: M25/M26 DURING QUILL FORWARD

To actuate the clamping device in an NC program with M25 or M26 the tailstock must be in back end position.

6059: C-AXIS SWING IN TIMEOUT

C-axis does not swivel in within 4 seconds.
Reason: not sufficient air pressure, and/or mechanics stuck.

6060: C-AXIS INDEX FAILURE

When swivelling in the C-axis the limit switch does not respond.
Check pneumatics, mechanics and limit switch.

6064: AUTOMATIC DOOR NOT READY

Door sticks mechanically (collision), insufficient pressured air supply, limit switch defective, fuse defective.
Check for collisions, check fuses or contact EMCO service.

6065: LOADER MAGAZINE FAILURE

Loader not ready.
Check if the loader is switched on, correctly connected and ready for operation and/or disable loader (WinConfig).

6066: CLAMPING DEVICE FAILURE

No compressed air at the clamping device
Check pneumatics and position of the clamping device proximity detectors.

6067: NO COMPRESSED AIR

Turn the compressed air on, check the setting of the pressure switch.

6068: MAINDRIVE OVERTEMPERATURE**6070: LIMIT SWITCH TAILSTOCK SLEEVE ACTIVE**

Cause: The axis arrived in the tailstock sleeve.
Remedy: Drive the travel off the tailstock sleeve.

6071: LIMIT SWITCH X AXIS ACTIVE

Cause: The axis arrived to the end switch.
Remedy: Drive the axis off the end switch again.

6072: LIMIT SWITCH Z AXIS ACTIVE

see 6071

6073: CHUCK GUARD OPEN

Cause: The chuck guard is open.
Remedy: Close the chuck guard.

6074: NO FEEDBACK FROM USB-PLC

Turn machine on/off. Check cabling, defective USB board.

6075: AXIS LIMIT SWITCH TRIGGERED

see 6071

6076: DRIVE Y-AXIS NOT READY

see 6010

6077 VICE NOT READY

Cause: Loss of pressure in clamping system.
Remedy: Check pressurised air and air ducts.

6078 MOTOR PROTECTION TOOL MAGAZINE RELEASED

Cause: Swing intervals are too short.
Remedy: Raise swing intervals.

6079 MOTOR PROTECTION TOOL CHANGER RELEASED

see 6068

6080 PRESSURE SWITCH FOR TANI MISSING

Cause: The pressure switch fails to active when the clamping closes. No pressurised air or mechanical problem.
Remedy: Check pressurised air.

6081 CLAMPING FOR TANI NOT OPEN

see 6080

6082 FAULT AS/SIGNAL

Cause: Active Safety-Signal X/Y-controller is faulty.
Remedy: Delete alarm using the RESET key and/or switch the machine on/off. If this error reoccurs, contact EMCO.

6083 FAULT AS/SIGNAL

Cause: Active Safety-Signal main spindle/Z-controller is faulty.
Remedy: Delete alarm using the RESET key and/or switch the machine on/off. If this error reoccurs, contact EMCO.

6084 FAULT AS/SIGNAL UE-MODUL

Cause: Active Safety-Signal Uncontrolled power supply module is faulty.
Remedy: Delete alarm using the RESET key and/or switch the machine on/off. If this error reoccurs, contact EMCO.

6085 N=0 RELAY NOT DE-ENERGIZED

Cause: Rotation zero relay did not drop.
Remedy: Delete alarm using the RESET key and/or switch the machine on/off. If this error reoccurs, contact EMCO (replace relay).

6086 DIFFERENT DOOR-SIGNALS FROM USBPLC AND ACC-PLC

Cause: ACC-PLC and USBSPS receive different door status reports.
Remedy: Delete alarm using the RESET key. If this error reoccurs, contact EMCO.

6087 DRIVE A-AXIS NOT READY

see 6010

6088 PROTECT SWITCH DOOR CONTROL UNIT RELEASED

Cause: Door drive overload.
Remedy: Cancel alarm with RESET button or switch machine on/off. If the problem occurs several times, contact EMCO (replace motor, drive).

6089 DRIVE B-AXIS NOT READY

see 6010

6090 CHIP CONVEYOR CONTACTOR NOT DE-ENERGIZED

Cause: Chip conveyor guard not down.
Remedy: Cancel alarm with RESET button or switch machine on/off. If the problem occurs several times, contact EMCO (replace guard).

6091 AUTOMATIC DOOR CONTACTOR NOT DE-ENERGIZED

Cause: Automatic door guard not down.
Remedy: Cancel alarm with RESET button or switch machine on/off. If the problem occurs several times, contact EMCO (replace guard).

6092 EMERGENCY-OFF EXTERNAL

6093 FAULT AS/SIGNAL A-AXIS

Cause: Active Safety-Signal A control element faulty.
Remedy: Cancel alarm with RESET button or switch machine on/off. If the problem occurs several times, contact EMCO.

6095 OVERHEATING IN THE SWITCHGEAR CABINET

Cause: Temperature monitoring responded.
Remedy: Check switchgear cabinet filter and fan, raise triggering temperature, switch machine on and off.

6096 SWITCHGEAR CABINET DOOR OPEN

Cause: Switchgear cabinet door opened without key switch release.
Remedy: Close switchgear cabinet door, switch machine off and on.

6097 EMERGENCY-OFF TEST REQUIRED

Cause: Functional test of Emergency off.
 Remedy: Press EMERGENCY-OFF button on the control panel and unlock again. Press Rest-button to acknowledge the emergency stop state.

6098 FLOAT SWITCH HYDRAULIC MISSING

Effect: Auxiliary units are switched off.
 Meaning: The hydraulic float switch has released.
 Remedy: Refill hydraulic oil.

6099 PROX. SWITCH SPINDLE-BRAKE 1 MISSING

Effect: Feed stop, Read in lock
 Meaning: M10 Spindle brake on → Inductive proximity switch stays 0.
 M11 Spindle brake off → Inductive proximity switch stays 1.
 Remedy: Check inductive proximity switch, check magnetiv valve spindle brake.

6100 LOW PRESSURE QUILL

Effect: Auxiliary units are switched off.
 Meaning: At the moment of a spindle start command the tailstock pressure was not built up or the pressure dropped while spindle run.
 Remedy: Check clamping device pressure and pressure switch.
 Check program.

6101 QUILL -B3 OR -B4 MISSING

Effect: Feed stop, Read in lock
 Meaning: The magnetic valve for the movement of the quill was activated, but the switches -B3 and -B4 does not alter its status.
 Remedy: Check switches, magnetic valves.

6102 QUILL POSITION ALARM (PART MOVED?)

Effect: Feed stop, Read in lock
 Meaning: The tailstock target position was overtravelled in AUTOMATIC mode.
 Remedy: Check tailstock target position, check technology (clamping device pressure higher, tailstock pressure lower)

6103 QUILL NO BACKPOSITION

Effect: Feed stop, Read in lock
 Meaning: The magnetic valve for the tailstock was activated, but the switch for "tailstock back" stays 0.
 Remedy: Check magnetic valve, check switch.

6104 LOW PRESSURE CLAMPING EQUIPMENT 1

Effect: Auxiliary units are switched off.
 Meaning: At the moment of a spindle start command the clamping pressure was not built up or the clamping pressure dropped while spindle run.
 Remedy: Check clamping device pressure and pressure switch.
 Check program.

6105 CLAMPING EQUIPMENT 1 NOT OPEN

Effect: Feed stop, Read in lock
 Meaning: The analogous proximity switch for clamping device 1 was not actuated.
 Remedy: Adjust inductive proximity switch (see "Machine Description - chapter "C Programming and operation").

6106 CLAMPING EQUIPMENT 1 NOT CLOSED

Effect: Feed stop, Read in lock
 Meaning: The pressure switch for "clamping device closed" does not switch.
 Remedy: Check pressure switch

6107 LIMIT SWITCH CLAMPING EQUIPMENT 1

Effect: Auxiliary units are switched off.
 Remedy: Adjust clamping device (do not clamp in end position of the clamping system - see "Machine Description, chapter C Programming and Operation").

6108 PARTS CATCHER FORWARD MISSING

Effect: Feed stop, Read in lock
 Meaning: The magnetic valve for "collection tray forward/backward" was activated, but the switch for "collection tray forward/backward" does not alter its status.
 Remedy: Check switches, magnetic valves.

6109 PARTS CATCHER ROTATE IN MISSING

Effect: Feed stop, Read in lock
 Meaning: The magnetic valve for "collection tray in/out" was activated, but the switch for "collection tray in/out" does not alter its status.
 Remedy: Check switch, magnetic valve.

6900 USBPLC not available

Cause: USB communication with the safety board could not be established.
 Remedy: Switch the machine off and on again. Please contact the EMCO after-sales service in case the error occurs repeatedly.

6901 Error emergency-off relay USBPLC

Cause: USBPLC EMERGENCY-OFF relay error.
Remedy: Switch the machine off and on again.
Please contact the EMCO after-sales service in case the error occurs repeatedly.

6902 Error standstill monitoring X

Cause: Unauthorized movement of the X axis in the current operating condition.
Remedy: Delete the alarm with the RESET button and switch the machine off and on again.
Please contact the EMCO after-sales service in case the error occurs repeatedly.

6903 Error standstill monitoring Z

Cause: Unauthorized movement of the Z axis in the current operating condition.
Remedy: Delete the alarm with the RESET button and switch the machine off and on again.
Please contact the EMCO after-sales service in case the error occurs repeatedly.

6904 Error alive circuit PLC

Cause: Error in the connection (Watchdog) of the safety board with the PLC.
Remedy: Delete the alarm with the RESET button and switch the machine off and on again. Please contact the EMCO after-sales service in case the error occurs repeatedly.

6906 Error overspeed spindle

Cause: The main spindle speed exceeds the maximum permissible value for the current operating condition.
Remedy: Delete the alarm with the RESET button and switch the machine off and on again. Please contact the EMCO after-sales service in case the error occurs repeatedly.

6907 Error enable pulses ER-module

Cause: ACC-PLC did not shutdown the input/negative feeder-module.
Remedy: Delete the alarm with the RESET button and switch the machine off and on again.
Please contact the EMCO after-sales service in case the error occurs repeatedly.

6908 Error standstill monitoring main drive

Cause: Unexpected warm up of the main spindle in the operating condition.
Remedy: Delete the alarm with the RESET button and switch the machine off and on again.
Please contact the EMCO after-sales service in case the error occurs repeatedly.

6909 Error main drive enable without spindle start

Cause: The release of the control unit of the main spindle was given by the ACC-PLC without the spindle-start key being pressed.
Remedy: Delete the alarm with the RESET button and switch the machine off and on again.
Please contact the EMCO after-sales service in case the error occurs repeatedly.

6910 Error standstill monitoring Y

Cause: Unauthorized movement of the Y axis in the current operating condition.
Remedy: Delete the alarm with the RESET button and switch the machine off and on again.
Please contact the EMCO after-sales service in case the error occurs repeatedly.

6911 Error standstill axes

Cause: Unauthorized movement of the axis in the current operating condition.
Remedy: Delete the alarm with the RESET button and switch the machine off and on again.
Please contact the EMCO after-sales service in case the error occurs repeatedly.

6912 Error overspeed axis

Cause: The feed of the axes exceeds the maximum permissible value for the current operating condition.
Remedy: Delete the alarm with the RESET button and switch the machine off and on again.
Please contact the EMCO after-sales service in case the error occurs repeatedly.

6913 Error overspeed X

Cause: The feed of the X axis exceeds the maximum permissible value for the current operating condition.
Remedy: Delete the alarm with the RESET button and switch the machine off and on again.
Please contact the EMCO after-sales service in case the error occurs repeatedly.

6914 Error overspeed Y

Cause: The feed of the Y axis exceeds the maximum permissible value for the current operating condition.
Remedy: Delete the alarm with the RESET button and switch the machine off and on again.
Please contact the EMCO after-sales service in case the error occurs repeatedly.

6915 Error overspeed Z

Cause: The feed of the Y axis exceeds the maximum permissible value for the current operating condition.

Remedy: Delete the alarm with the RESET button and switch the machine off and on again. Please contact the EMCO after-sales service in case the error occurs repeatedly.

6916 ERROR: X-INDUCTIVE PROXIMITY SWITCH DEFECT

Cause: No signal is delivered by X axis Bero.

Remedy: Delete alarm using the RESET key. If this error reoccurs, contact EMCO.

6917 ERROR: Y-INDUCTIVE PROXIMITY SWITCH DEFECT

Cause: No signal is delivered by Y axis Bero.

Remedy: Delete alarm using the RESET key. If this error reoccurs, contact EMCO.

6918 ERROR: Z-INDUCTIVE PROXIMITY SWITCH DEFECT

Cause: No signal is delivered by Z axis Bero.

Remedy: Delete alarm using the RESET key. If this error reoccurs, contact EMCO.

6919 ERROR: SPINDLE-INDUCTIVE PROXIMITY SWITCH DEFECT

Cause: No signal is delivered by main spindle Bero.

Remedy: Delete alarm using the RESET key. If this error reoccurs, contact EMCO.

6920 INVERSION OF X-DIRECTION TOO LONG "1"

Cause: The change in direction of X axis was being sent to USBSPS for more than three seconds.

Remedy: Delete alarm using the RESET key. Avoid driving back and forth using the manual wheel. If this error reoccurs, contact EMCO.

6921 INVERSION OF Y-DIRECTION TOO LONG "1"

Cause: The change in direction of Y axis was being sent to USBSPS for more than three seconds.

Remedy: Delete alarm using the RESET key. Avoid driving back and forth using the manual wheel. If this error reoccurs, contact EMCO.

6922 INVERSION OF Z-DIRECTION TOO LONG "1"

Cause: The change in direction of Z axis was being sent to USBSPS for more than three seconds.

Remedy: Delete alarm using the RESET key. Avoid driving back and forth using the manual wheel. If this error reoccurs, contact EMCO.

6923 DIFFERENT DOOR-SIGNALS FROM USBPLC AND ACC-PLC

Cause: ACC-PLC and USBSPS receive different door status reports.

Remedy: Delete alarm using the RESET key. If this error reoccurs, contact EMCO.

6924 ERROR ENABLE PULSES MAIN DRIVE

Cause: The pulse release on the main spindle control element was interrupted by the USBSPS, as the PLC did not shut it down in a timely fashion.

Remedy: Cancel alarm with RESET button. If the problem occurs several times, contact EMCO.

6925 GRID PROTECTION ERROR!

Cause: Grid protection does not drop out in current operating state, or does not engage.

Remedy: Clear alarm with emergency off button and restart the machine. Contact EMCO Customer Service if the error occurs on several occasions.

6926 MOTOR PROTECTION ERROR!

Cause: Motor protection drops out in current operating state.

Remedy: Clear alarm with emergency off button and restart the machine. Contact EMCO Customer Service if the error occurs on several occasions.

6927 EMERGENCY OFF ACTIVE ERROR!

Cause: Emergency off button was pressed.

Remedy: Restart the machine.

6928 TOOL CHANGER SHUTDOWN MONITORING ERROR

Cause: Unauthorised tool changer movement in the current operating state.

Remedy: Clear alarm with emergency off button and restart the machine. Contact EMCO Customer Service if the error occurs on several occasions.

6929 MACHINE DOOR CLOSING/LOCKING ERROR

Cause: State of the door lock not plausible or door closure unserviceable.

Remedy: Clear alarm with emergency off button and restart the machine. Contact EMCO Customer Service if the error occurs on several occasions.

6930 BEROS MAIN SPINDLE PLAUSIBILITY ERROR

Cause: Beros main spindle signal different.
 Remedy: Clear alarm with emergency off button and restart the machine. Contact EMCO Customer Service if the error occurs on several occasions.

6931 MAIN DRIVE QUICK STOP FUNCTION PLAUSIBILITY ERROR

Cause: Main drive actuator does not confirm the quick stop function in the current operating state.
 Remedy: Clear alarm with emergency off button and restart the machine. Contact EMCO Customer Service if the error occurs on several occasions.

6999 USB-EXTENSION FOR ROBOTIK NOT AVAILABLE

Cause: The USB extension for robotics cannot be addressed by ACC.
 Remedy: Contact EMCO.

7000: INVALID TOOL NUMBER PROGRAMMED

The tool position was programmed larger than 8. The CNC program will be stopped. Interrupt program with RESET and correct the program.

7007: FEED HOLD

In the robotic mode a HIGH signal is at input E3.7. Feed Stop is active until a low signal is at E3.7.

7016: SWITCH ON AUXILIARY DRIVES

The auxiliary drives are off. Press the AUX ON key for at least 0.5 sec. (to avoid accidentally switching on) to switch on the auxiliary drives (also a lubricating pulse will be released).

7017: REFERENCE MACHINE

Approach the reference point.
 When the reference point is not active, manual movements are possible only with key switch at position "setting operation".

7018: TURN KEY SWITCH

With NC-Start the key switch was in position "setting operation".
 NC-Start is locked.
 Turn the key switch in the position "automatic" to run a program.

7019: PNEUMATIC LUBRICATION MONITORING!

Refill pneumatic oil

7020: SPECIAL OPERATION MODE ACTIVE

Special operation mode: The machine door is opened, the auxiliary drives are switched on, the key switch is in position "setting operation" and the consent key is pressed.

Manual traversing the axes is possible with open door. Swivelling the tool turret is possible with open door. Running a CNC program is possible only with standing spindle (DRYRUN) and SINGLE block operation.

For safety: If the consent key is pressed for more than 40 sec. the function of this key is interrupted, the consent key must be released and pressed again.

7021: TOOL TURRET NOT LOCKED

The tool turret operating was interrupted. NC start and spindle start are locked. Press the tool turret key in the RESET status of the control.

7022: COLLECTION DEVICE MONITORING

Time exceed of the swivelling movement. Check the pneumatics, respectively whether the mechanical system is jammed (possibly a workpiece is jammed).

7023: ADJUST PRESSURE SWITCH !

During opening and closing of the clamping device the pressure switch has to turn off and on once.

Adjust the pressure switch. This alarm does not exist any more for versions starting with PLC 3.10.

7024: ADJUST CLAMPING DEVICE PROXIMITY SWITCH !

When the clamping device is open and the position stop control is active, the respective proximity switch has to feed back that the clamping device is "Open".

Check and adjust the clamping device proximity switch, check the cables.

7025 WAITING TIME MAIN DRIVE !

The LENZE frequency converter has to be separated from the mains supply for at least 20 seconds before you are allowed to switch it on again. This message will appear when the door is quickly opened/ closed (under 20 seconds).

7026 PROTECTION MAIN MOTOR FAN RELEASED!

7038: LUBRICATION SYSTEM FAULT

The pressure switch is defective or gagged. NC-Start is locked. This alarm can be reset only by switching off and on the machine. Contact EMCO service.

7039: LUBRICATION SYSTEM FAULT

Not enough lubricant, the pressure switch is defective. NC-Start is locked. Check the lubricant and lubricate manually or contact EMCO service.

7040: MACHINE DOOR OPEN

The main drive can not be switched on and NC-Start can not be activated (except special operation mode) Close the machine to run a program.

7041: GEARBOX COVER OPEN

The main spindle cannot be switched on and NC start cannot be activated. Close the gearbox cover in order to start a CNC program.

7042: INITIALIZE MACHINE DOOR

Every movement and NC-Start are locked. Open and close the machine door to initialize the safety circuits.

7043: PIECE COUNT REACHED

A predetermined number of program runs was reached. NC-Start is locked. Reset the counter to continue.

7048: CHUCK OPEN

This message shows that the chuck is open. It will disappear if a workpiece will be clamped.

7049: CHUCK - NO PART CLAMPED

No part is clamped, the spindle can not be switched on.

7050: COLLET OPEN

This message shows that the collet is open. It will disappear if a workpiece will be clamped.

7051: COLLET - NO PART CLAMPED

No part is clamped, the spindle can not be switched on.

7052: QUILL IN UNDEFINED POSITION

The tailstock is in no defined position. All axis movements, the spindle and the tool turret are locked. Drive the tailstock in back end position or clamp a workpiece with the tailstock.

7053: QUILL - NO PART CLAMPED

The tailstock reached the front end position. Traverse the tailstock back to the back end position to continue.

7054: NO PART CLAMPED

No part clamped, switch-on of the spindle is locked.

7055: CLAMPING DEVICE OPEN

This message indicates that the clamping device is not in clamping state. It disappears as soon as a part is clamped.

7060 RETRACT SLEEVE LIMIT SWITCH !

The axis arrived in the tailstock sleeve. Drive the travel off the tailstock sleeve.

7061 RETRACT X AXIS LIMIT SWITCH !

The axis arrived to the end switch. Drive the axis off the end switch again.

7062 RETRACT Z AXIS LIMIT SWITCH !

see 7061

7063 OIL LEVEL CENTRAL LUBRICATION !

Low oil level in central lubrication. Refill oil as per maintenance instructions to the machine.

7064 CHUCK GUARD OPEN !

The chuck guard is open. Close the chuck guard.

7065 MOTOR PROTECTION COOLANT PUMP RELEASED !

Overheated coolant pump. Check the coolant pump for ease of motion and presence of dirt. Ensure sufficient amount of coolant fluid in the coolant facility.

7066 CONFIRM TOOL !

To confirm the tool change, press T after the change has been completed.

7067 MANUAL OPERATING MODE

The Special Operation key switch is in the Set position (manual).

7068 X AXIS HANDWHEEL ACTIVE

The safety wheel is locked for manual travel movement. The safety wheel locking is monitored by contactless switches. With the manual wheel locked, the axis feed cannot be switched on. For automatic processing of a program, the manual wheel must be released again.

7069 Y AXIS HANDWHEEL ACTIVE

see 7068

7070 Z AXIS HANDWHEEL ACTIVE

see 7068

7071 VERTICAL TOOL CHANGE

The sheath for manual clamping of the tool holder is monitored by a switch. The switch reports a unaccepted socket wrench or a sheath which was left open. Remove the socket wrench after clamping the tool and close the sheath.

7072 HORIZONTAL TOOL CHANGE

The turning knob for manual tool clamping on the horizontal spindle is monitored by a switch. The switch reports a tightened turning knob. The spindle gets locked. Release the turning knob after clamping the tool.

7073 RETRACT Y AXIS LIMIT SWITCH !

see 7061

7074 CHANGE TOOL

Clamp programmed tool.

7076: SWIVEL UNIT VOR MILLING HEAD UNLOCKED

The milling head is not fully swung. Fix the milling head mechanically (the end switch must be pushed).

7077: ADJUST TOOL TURRET

No valid machine data for tool change are available. Contact EMCO.

7078: POCKET NOT IN HOME POSITION

Cancel during tool change. Swing back tool recessed in setup operation.

7079: TOOL ARM NOT IN HOME POSITION

see 7079

7080: INCORRECT TOOL CLAMPED !

The tool cone lies beyond tolerance. The clamped tool is twisted by 180°. Bero tool clamping is displaced. Check the tool and clamp it again. If this problem occurs with more tools, contact EMCO.

7082: MOTOR PROTECTION CHIP CONVEY-OR RELEASED

The scrap belt is overloaded. Check the conveyor belt for ease of motion and remove jammed scrap.

7083: MAGAZINE IS ACTIVE !

A tool has been removed from the non-chaotic tool administration from the main spindle. Fill the tool drum.

7084: VICE OPEN !

The vice is not clamped. Clamp the vice.

7085 ROUNDAXIS A MOVE TO 0 DEGRE !

Cause: The MOC only shuts down if the A Round axis is at 0°.

When 4.5. is present, a round axis must be made each time before the machine is switched off.

Remedy: Move round axis to 0°.

7088 SWITCHGEAR CABINET OVERHEATING

Cause: Temperature monitoring responded.

Remedy: Check switchgear cabinet filter and fan, raise trigger temperature.

7089 SWITCHGEAR CABINET DOOR OPEN

Cause: Switchgear cabinet door open.

Remedy: Close switchgear cabinet door.

7091 WAIT FOR USB-I2C SPS

Cause: Communication with the USB-I2C PLC could not be established.

Remedy: If the message does not self-extinguish, switch off and on the machine. Please contact EMCO service when the message occurs permanently even after power off.

7092 TEST STOP ACTIVE

Cause: Safety test for monitoring the safety functions is active.

Remedy: Wait until the safety test is finished.

7093 SET REFERENCE POINT

Cause: The reference point acknowledge mode was activated by the operator.

7094 SET X-REFERENCE POINT

Cause: The reference value of the X axis was adopted to the acc.esd file.

7095 SET Y-REFERENCE POINT

Cause: The reference value of the Y axis was adopted to the acc.esd file.

7096 SET Z-REFERENCE POINT

Cause: The reference value of the Z axis was adopted to the acc.esd file.

7097 FEED OVERRIDE 0

Cause: The override switch (feed control) was set by the operator on 0%

7098 SPINDLE-BRAKE 1 ACTIVE

Effect: spindle stop.

7099QUILL DRIVES FORWARD

Effect: Feed stop, Read in lock

Meaning: M21 was programmed → pressure switch "tailstock in front position" is not yet 1.

Remedy: Disappears with pressure switch front position.

7100 QUILL DRIVES BACKWARD

Effect: Feed stop, Read in lock

Meaning: M20 was programmed → limit switch "tailstock back" is not yet 1

Remedy: Disappears with limit switch "backposition".

7101 REFERENCE POINT TOOL TURRET MISSING

Effect: Feed stop, Read in lock

Meaning: At NC start the tool turret is not referenced.

Remedy: Reference tool turret in JOG mode with tool turret key.

7102 TOOL TURRET IN MOTION

Effect: Tool turret swivels to the programmed position.

7103 LIMIT-SWITCH CLAMPING EQUIPMENT 1

Effect: Locking of NC start and main drive start, spindle stop S1

Meaning: The pick-up for the analouge value detects the clamping position as end position.

Remedy: Change clamping range of the clamping device (see "Machine Description - chapter C Programming and Operation").

7104 QUILL IN INTERMEDIATE POSITION

Effect: Feed hold / read in stop.

7105 SET AWZ REFERENCE POINT

Effect: The reference value of the AWZ motor was transferred to the acc.msdc file.

7900 INITIALIZE EMERGENCY OFF!

Cause: The emergency off button must be initialized.

Remedy: Press and then release emergency off button.

7901 INITIALIZE MACHINE DOORS!

Cause: The machine doors must be initialized.

Remedy: Open the machine doors and close them again.

7906 SET A-REFERENCE POINT

Cause: The reference value of the A axis was adopted to the acc.esd file.

Inputunit alarms 1700 - 1899

These alarms and messages are raised by the control keyboard.

1701 Error in RS232

Cause: Serial port settings are invalid or the connection to the serial keyboard were interrupted.

Remedy: Check the settings of the serial interface and/or turn keyboard off/on and check the control cable connection.

1703 Ext. keyboard not available

Cause: Connection with the external keyboard can not be made.

Remedy: Check the settings of the external keyboard and/or check the cable connection.

1704 Ext. keyboard: checksum error

Cause: Error in the transmission.

Remedy: The connection to the keyboard is automatically restored. If this fails, turn off or on the keyboard.

1705 Ext. keyboard: general error

Cause: The attached keyboard reported an error.

Remedy: Plug the keyboard off and on again. Contact EMCO Customer Service if the error occurs on several occasions.

1706 General USB error

Cause: Error in the USB communication.

Remedy: Plug the keyboard off and on again. Contact EMCO Customer Service if the error occurs on several occasions

1707 Ext. Keyboard: no LEDs

Cause: Fehlerhaftes LED-Kommando wurde an die Tastatur gesandt.

Remedy: EMCO-Service kontaktieren.

1708 Ext. Keyboard: unknown command

Cause: Unknown command was sent to the keyboard.

Remedy: Contact EMCO Customer Service

1710 Installation of Easy2control is damaged!

Cause: Incorrect installation of Easy2control

Remedy: Reinstall software and/or contact EMCO Customer Service

1711 Initialization of Easy2Control failed!

Cause: Configuration file onscreen.ini for Easy2control is missing.

Remedy: Reinstall software and/or contact EMCO Customer Service.

1712 USB-Dongle for Easy2control could not be found!

Cause: USB-Dongle for Easy2control is not connected. Easy2control is displayed but can not be operated.

Remedy: Connect USB-Dongle for Easy2control.

1801 Keytable not found!

Cause: The file with the keytable couldn't be found.

Remedy: Reinstall software and/or contact EMCO Customer Service.

1802 Connection to keyboard lost

Cause: Connection to the serial keyboard was interrupted.

Remedy: Turn keyboard off/on and check the cable connection.

Axis Controller Alarms

8000 - 9000, 22000 - 23000, 200000 - 300000

8000 Fatal Error AC

8100 Fatal init error AC

Cause: Internal error

Remedy: Restart software or reinstall when necessary, report to EMCO, if repeatable.

8101 Fatal init error AC

see 8101.

8102 Fatal init error AC

see 8101.

8103 Fatal init error AC

see 8101.

8104 Fatal system error AC

see 8101.

8105 Fatal init error AC

see 8101.

8106 No PC-COM card found

Cause: PC-COM board can not be accessed (ev. not mounted).

Remedy: Mount board, adjust other address with jumper

8107 PC-COM card not working

see 8106.

8108 Fatal error on PC-COM card

see 8106.

8109 Fatal error on PC-COM card

see 8106.

8110 PC-COM init message missing

Cause: Internal error

Remedy: Restart software or reinstall when necessary, report to EMCO, if repeatable.

8111 Wrong configuration of PC-COM

see 8110.

8113 Invalid data (pccom.hex)

see 8110.

8114 Programming error on PC-COM

see 8110.

8115 PC-COM packet acknowledge missing

see 8110.

8116 PC-COM startup error

see 8110.

8117 Fatal init data error (pccom.hex)

see 8110.

8118 Fatal init error AC

see 8110, ev. insufficient RAM memory

8119 PC interrupt no. not valid

Cause: The PC interrupt number can not be used.

Remedy: Find out free interrupt number in the Windows95 system control (allowed: 5,7,10, 11, 12, 3, 4 und 5) and enter this number in WinConfig.

8120 PC interrupt no. unmaskable

see 8119

8121 Invalid command to PC-COM

Cause: Internal error or defective cable

Remedy: Check cables (screw it); Restart software or reinstall when necessary, report to EMCO, if repeatable.

8122 Internal AC mailbox overrun

Cause: Internal error

Remedy: Restart software or reinstall when necessary, report to EMCO, if repeatable.

8123 Open error on record file

Cause: Internal error

Remedy: Restart software or reinstall when necessary, report to EMCO, if repeatable.

8124 Write error on record file

Cause: Internal error

Remedy: Restart software or reinstall when necessary, report to EMCO, if repeatable.

8125 Invalid memory for record buffer

Cause: Insufficient RAM, record time exceeding.

Remedy: Restart software, ev. remove drivers etc. to gain more RAM, reduce record time.

8126 AC Interpolation overrun

Cause: Ev. insufficient computer performance.

Remedy: Set a longer interrupt time in WinConfig. This may result in poorer path accuracy.

8127 Insufficient memory

Cause: Insufficient RAM

Remedy: Close other programs, restart software, ev. remove drivers etc. to gain more RAM.

8128 Invalid message to AC

Cause: Internal error

Remedy: Restart software or reinstall when necessary, report to EMCO, if repeatable.

8129 Invalid MSD data - axisconfig.

see 8128.

8130 Internal init error AC

see 8128.

8130 Internal init error AC

see 8128.

8132 Axis accessed by multiple channels

see 8128.

8133 Insufficient NC block memory AC

see 8128.

8134 Too much center points programmed

see 8128.

8135 No centerpoint programmed

see 8128.

8136 Circle radius too small

see 8128.

8137 Invalid for Helix specified

Cause: Wrong axis for helix. The combination of linear and circular axes does not match.

Remedy: Program correction.

8140 Maschine (ACIF) not responding

Cause: Machine off or not connected.

Remedy: Switch on machine or connect.

8141 Internal PC-COM error

Cause: Internal error

Remedy: Restart software or reinstall when necessary, report to EMCO, if repeatable.

8142 ACIF Program error

Cause: Internal error

Remedy: Restart software or reinstall when necessary, report to EMCO, if repeatable.

8143 ACIF packet acknowledge missing

see 8142.

8144 ACIF startup error

see 8142.

8145 Fatal init data error (acif.hex)

see 8142.

8146 Multiple request for axis

see 8142.

8147 Invalid PC-COM state (DPRAM)

see 8142.

8148 Invalid PC-COM command (CNo)

see 8142.

8149 Invalid PC-COM command (Len)

see 8142.

8150 Fatal ACIF error

see 8142.

8151 AC Init Error (missing RPG file)

see 8142.

8152 AC Init Error (RPG file format)

see 8142.

8153 FPGA program timeout on ACIF

see 8142.

8154 Invalid Command to PC-COM

see 8142.

8155 Invalid FPGA packet acknowledge

see 8142 or hardware error on ACIF board (contact EMCO Service).

8156 Sync within 1.5 revol. not found

see 8142 or Bero hardware error (contact EMCO Service).

8157 Data record done

see 8142.

8158 Bero width too large (referencing)

see 8142 or Bero hardware error (contact EMCO Service).

8159 Function not implemented

Bedeutung: In normal operation this function can not be executed

8160 Axis synchronization lost axis 3..7

Cause: Axis spins or slide is locked, axis synchronisation was lost

Remedy: Approach reference point

8161 X-Axis synchronization lost

Step loss of the step motor. Causes:

- Axis mechanically blocked
- Axis belt defective
- Distance of proximity detector too large (>0,3mm) or proximity detector defective
- Step motor defective

8162 Y-Axis synchronization lost

see 8161

8163 Z-Axis synchronization lost

see 8161

8164 Software limit switch max axis 3..7

Cause: Axis is at traverse area end

Remedy: Retract axis

8168 Software limit overtravel axis 3..7

Cause: Axis is at traverse area end

Remedy: Retract axis

8172 Communication error to machine

Cause: Internal error

Remedy: Restart software or reinstall when necessary, report to EMCO, if repeatable. Check connection PC - machine, eventually eliminate distortion sources.

8173 INC while NC program is running

Remedy: Stop the program with NC stop or with Reset. Traverse the axis.

8174 INC not allowed

Cause: At the moment the axis is in motion.

Remedy: Wait until the axis stops and then traverse the axis.

8175 MSD file could not be opened

Cause: Internal error

Remedy: Restart software oder bei Bedarf neu installieren, report to EMCO, if repeatable.

8176 PLS file could not be opened

see 8175.

8177 PLS file could not be accessed

see 8175.

8178 PLS file could not be written

see 8175.

8179 ACS file could not be opened

see 8175.

8180 ACS file could not be accessed

see 8175.

8181 ACS file could not be written

see 8175.

8183 Gear too high

Cause: The selected gear step is not allowed at the machine.

8184 Invalid interpolaton command**8185 Forbidden MSD data change**

see 8175.

8186 MSD file could not be opened

see 8175.

8187 PLC program error

see 8175.

8188 Gear command invalid

see 8175.

8189 Invalid channel assignement

see 8175.

8190 Invalid channel within message

see 8175.

8191 Invalid jog feed unit

Cause: The machine does not support the rotation feed in the JOG operating mode.

Remedy: Order a software update from EMCO.

8192 Invalid axis in command

see 8175.

8193 Fatal PLC error

see 8175.

8194 Thread without length

Cause: The programmed target coordinates are identical to the starting coordinates.

Remedy: Correct the target coordinates.

8195 No thread slope in leading axis

Remedy: Program thread pitch

8196 Too many axis for thread

Remedy: Program max. 2 axes for thread.

8197 Thread not long enough

Cause: Thread length too short.

With transition from one thread to the other the length of the second thread must be sufficient to produce a correct thread.

Remedy: Longer second thread or replace it by a linear interpolation (G1).

8198 Internal error (to many threads)

see 8175.

8199 Internal error (thread state)

Cause: Internal error

Remedy: Restart software or reinstall when necessary, report to EMCO, if repeatable.

8200 Thread without spindle on

Remedy: Switch on spindle

8201 Internal thread error (IPO)

see 8199.

8201 Internal thread error (IPO)

see 8199.

8203 Fatal AC error (0-ptr IPO)

see 8199.

8204 Fatal init error: PLC/IPO running

see 8199.

8205 PLC Runtime exceeded

Cause: Insufficient computer performance

8206 Invalid PLC M-group initialisation

see 8199.

8207 Invalid PLC machine data

see 8199.

8208 Invalid application message

see 8199.

8212 Rotation axis not allowed

see 8199.

8213 Circle and rotation axis can't be interpolated**8214 Thread and rotation axis cant't be interpolated****8215 Invalid state**

see 8199.

8216 No rotation axis for rotation axis switch

see 8199.

8217 Axis type not valid!

Cause: Switching during the rotary axis operating mode when the spindle is running.

Remedy: Stop the spindle and switch over to the rotary axis operating mode.

8218 Referencing round axis without selected round axis!

see 8199.

8219 Thread not allowed without spindle encoder!

Cause: Thread cutting, respectively tapping is only possible with spindles with encoders.

8220 Buffer length exceeded in PC send message!

see 8199.

8221 Spindle release although axis is no spindle!

see 8199.

8222 New master spindle is not valid

Cause: The indicated master spindle is not valid when switching over to the master spindle.

Remedy: Correct the spindle number.

8224 Invalid stop mode

see 8199.

8225 Invalid parameter for BC_MOVE_TO_IO!

Cause: The machine is not configured for touch probes. A traversing movement with rotary axis is not allowed during touch probe operating mode.

Remedy: Remove the rotary axis movement from the traversing movement.

8226 Rotary axis switch not valid (MSD data)!

Cause: The indicated spindle does not have a rotary axis.

8228 Rotary axis switch not allowed while axis move!

Cause: The rotary axis has moved during switching over to the spindle operating mode.

Remedy: Stop the rotary axis before switching.

8229 Spindle on not allowed while rotary axis is active!**8230 Program start not allowed due to active spindle rotation axis!****8231 Axis configuration (MSD) for TRANSMIT not valid!**

Cause: Transmit is not possible at this machine.

8232 Axis configuration (MSD) for TRACYL not valid!

Cause: Tracyl is not possible at this machine.

8233 Axis not available while TRANSMIT/TRACYL is active!

Cause: Programming of the rotary axis is not allowed during Transmit/ Tracyl.

8234 Axis control grant removed by PLC while axis interpolates!

Cause: Internal error

Remedy: Delete error with reset and inform EMCO.

8235 Interpolation invalid while axis control grant is off by PLC!

see 8234.

8236 TRANSMIT/TRACYL activated while axis or spindle moves!

see 8234.

8237 Motion through pole in TRANSMIT!

Cause: It is not allowed to move through the coordinates X0 Y0 in Transmit.

Remedy: Alter the traversing movement.

8238 Speed limit in TRANSMIT exceeded!

Cause: The traversing movement gets too close to the coordinates X0 Y0. In order to observe the programmed feed rate, the maximum speed of the rotary axis would have to be exceeded.

Remedy: Reduce the feed rate. Set the value of the C-axis feed limitation in WinConfig, machine data settings / general machine data/ to 0.2. Thus, the feed rate will be automatically reduced near the coordinates X0 Y0.

The distance to the center is calculated with the following formula:

for CT155/CT325/CT450:

$$F[\text{mm/min}] * 0.0016 = \text{distance} [\text{mm}]$$

for CT250:

$$F[\text{mm/min}] * 0.00016 = \text{distance} [\text{mm}]$$

This applies for rapid traverse in transmit:

CT155/250/325: 4200 mm/min

CT450: 3,500 mm/min

8239 DAU exceeded 10V limit!

Cause: Internal error

Remedy: Start the software again or install it anew. Report the error to EMCO.

8240 Function not valid during active transformation (TRANSMIT/TRACYL)!

Cause: The Jog and INC operating mode are not possible during Transmit in X/C and during Tracyl in the rotary axis.

8241 TRANSMIT not enabled (MSD)!

Cause: Transmit is not possible at this machine.

8242 TRACYL not enabled (MSD)!

Cause: Tracyl is not possible at this machine.

8243 Round axis invalid during active transformation!

Cause: It is not allowed to program the rotary axis during Transmit/Tracyl.

8245 TRACYL radius = 0!

Cause: When selecting Tracyl, a radius of 0 was used.

Remedy: Correct the radius.

8246 Offset alignment not valid for this state!

see 8239.

8247 Offset alignment: MSD file write protected!**8248 Cyclic supervision failed!**

Cause: The communication with the machine keyboard is interrupted.

Remedy: Start the software again or install it anew. Report the error to EMCO.

8249 Axis motion check alarm!

see 8239

8250 Spindle must be rotation axis !

see 8239

8251 Lead for G331/G332 missing !

Cause: The threading pitch is missing or the starting coordinates are identical to the target coordinates.

Remedy: Program the threading pitch.
Correct the target coordinates.

8252 Multiple or no linear axis programmed for G331/G332 !

Remedy: Program exactly one linear axis.

8253 Speed value for G331/G332 and G96 missing !

Cause: No cutting speed has been programmed.

Remedy: Program the cutting speed.

8254 Value for thread starting point offset not valid!

Cause: The thread starting point offset is not within the range of 0 to 360°.

Remedy: Correct the thread starting point offset.

8255 Reference point not in valid software limits!

Cause: The reference point has been defined outside the software limit switches.

Remedy: Correct the reference points in WinConfig.

8256 Spindle speed too low while executing G331/G332!

Cause: During tapping the spindle speed has decreased. Perhaps the incorrect threading pitch was used or the core drilling is not correct.

Remedy: Correct the threading pitch. Adapt the diameter to the core drilling.

8257 Real Time Module not active or PCI card not found!

Cause: ACC could not be started correctly or the PCI card in the ACC was not recognized.

Remedy: Report the error to EMCO.

8258 Error allocating Linux data!

see 8257.

8259 Current thread in sequence not valid!

Cause: One block of a thread in sequence has been programmed without thread G33.

Remedy: Correct the program.

8260 Change of leading axis within the thread sequence !

Cause: Occurs if the thread run-out of the longitudinal thread is set so that it's not possible to reach the target point. with the required stopping distance

Remedy: The thread run-out should be at least as large as the pitch. this error also occurs. if the pitch of a thread chain is too large when changing the leading axis.

8261 Missing thread in sequence !

Cause: A successive thread has not been programmed for a thread in sequence, the number has to be in accordance with the SETTHREADCOUNT () that has been defined before.

Remedy: Correct the number of threads in the thread in sequence and add a thread.

8262 Reference marks are not close enough !

Cause: The settings of the linear scale have been changed or the linear scale is defective.

Remedy: Correct the settings. Contact EMCO.

8263 Reference marks are too close together!

see 8262.

8265 No or wrong axis in axis switch command!

Cause: Internal error.

Remedy: Please contact the EMCO after-sales service.

8266 Invalid tool

Cause: Programmed tool is not set in magazine.

Remedy: Correct tool number and/or load tool in magazine.

8267 Speed difference to high

Cause: Die Soll- und Istgeschwindigkeit der Achse weichen zu stark voneinander ab.

Remedy: Run the program again with reduced feed. If this does not remedy the problem, contact EMCO.

8269 USBSPS and ACC speed values or override are different

Cause: USBSPS and ACC have different rotations saved.

Remedy: Delete alarm using the RESET key. If this error reoccurs, contact EMCO.

8270 Reference switch defective

Cause: The reference switch did not switch within the specified range.

Remedy: Cancel alarm with RESET button. If the problem occurs several times, contact EMCO.

8271 Tool load in locked place not possible

Cause: There was an attempt to swing a tool into a locked place in the magazine.

Remedy: Choose a free, unlocked place in the magazine and then swing the tool into the magazine.

8272 Old PLC version, update necessary

Cause: The PLC version is too old to fully support randomised tool management.

Remedy: Update the PLC.

8273 Spindle overload

Cause: The spindle was overloaded and during processing the speed fell (to half of the target speed for more than 500ms).

Remedy: Cancel alarm with RESET button. Change the cut data (feed, speed, infeed).

8274 Define tool before loading

Cause: The tool must be defined in the tool list before it is possible to transfer the tool into the spindle.

Remedy: Create the tool in the tool list, then load.

8275 Could not read position from absolute encoder

Cause: The position of an absolute encoder could not be read.

Remedy: Turn off and on the machine. Contact EMCO service if the error occurs multiple times

8276 Physical axis left the valid travel range

Cause: An axis with absolute encoder is outside the valid range for travel.

Remedy: Turn off and on the machine. Contact EMCO service if the error occurs multiple times.

8277 Sinamics drive package error active

Cause: Error in Sinamics drive.

Remedy: Turn off and on the machine. Contact EMCO service if the error occurs multiple times.

8278 Control not compatible with ACpn

Cause: The WinNC control is incompatible with the ACpn machine.

Remedy: Install a WinNC control which is compatible with the ACpn.

8279 Connection to drive got lost

Cause: the connection between ACpn and CU320 was lost.

Remedy: Turn off and on the machine. Contact EMCO service if the error occurs multiple times

8280 Reference point in setting data not equivalent with machine data, please check!

Cause: The reference point saved in the AC setting data does not match the reference point in the machine data (ACC_MSD).

Remedy: Measure the reference point of all axes anew and enter into EMConfig.

8704 Feed override absent, REPOS is not executed

Cause: The REPOS command is not executed because the feed override is set to 0%.

Remedy: Change the feed override and restart REPOS.

8705 Tool sorting active

Cause: The tools will be re-sorted with random tool management to facilitate non-random operation (tool 1 at place 1, tool 2 at place 2, etc.).

Remedy: Wait until sorting has finished. The controller will delete the report independently.

8706 Check new controller - tool table

Cause: The controller was changed with random tool management active.

Remedy: Check the tool or place table to clear the alarm.

8707 Ending with auxiliary drives switched on not possible

Cause: An attempt was made to end the controller, although the auxiliary drives are still switched on.

Remedy: Switch off the auxiliary drives and then end the controller.

8710 Initiating communication with drives

Cause: ACpn connects to the Sinamics drives

Remedy: Wait until the connection was established.

8712 JOG in X and C deactivated during Transmit

Cause: JOG in X and C is not possible at active Transmit.

22000 Gear change not allowed

Cause: Gear step change when the spindle is active.

Remedy: Stop the spindle and carry out a gear step change.

22270 Feed too high (thread)

Cause: Thread pitch too large / missing, Feed for thread reaches 80% of rapid feed

Remedy: Program correction, lower pitch or lower spindle speed for thread

200000 to 300000 are specific to the drives and show up only in combination with the alarm # "8277 Sinamics error".**201699 - „(F) SI P1 (CU): Test of the shutdown path is necessary“**

Cause: A test of the shutdown path is necessary. The machine remains operational.

Remedy: The test is performed automatically during the next restart of the WinNC.

235014 TM54F: Teststop necessary

Cause: A teststop is necessary.

Remedy: Shutdown and restart the WinNC. The test is performed automatically during restart.

Axis Controller Messages

8700 Execute REPOS in all axes before program start

Cause: After the program was stopped, the axes were manipulated with the hand wheel or with the jog keys and then a restart of the program was attempted.

Remedy: Before starting the program again, one should reposition the axes along the contour by executing "REPOS".

8701 No NCStop during offset align

Cause: The machine is currently executing an automatic offset adjustment. NC stop is not possible at this time.

Remedy: Wait until the offset adjustment is finished and then stop the program with NC stop.

8702 No NCStop during positioning after block search

Cause: The machine is currently finishing the block search operation and then it starts to go back to the last programmed position. No NC stop is possible in the meantime.

Remedy: Wait until positioning is finished and then stop the program with NC stop.

8703 Data record done

The recording of data is finished and the file record.acp has been copied to the installation folder.

8705 Feed-override missing, REPOS will not be executed

Cause: The spindle was overloaded and during processing the speed fell (to half of the target speed for more than 500ms).

Remedy: Cancel alarm with RESET button. Change the cut data (feed, speed, infeed).

8706 Tool sorting active

Cause: The tools were resorted during randomised tool management in order to enable non-randomised operation (tool 1 to place 1, tool 2 to place 2, etc.).

Remedy: Wait till the sorting is finished. The message will be deleted automatically by the control system.

8707 New control - please check tool table

Cause: The control system was changed when randomised tool management was active.

Remedy: Check the tool or place table to cancel the alarm.

8708 Switch off auxiliary drives for shutdown

Cause: There was an attempt to shut down the control system although the auxiliary drives are still switched on.

Remedy: Switch off the auxiliary drives and then shut down the control system.

8709 Insert tool in spindle for loading

Cause: During loading a tool must be physically available in the spindle.

Remedy: Clamp tool in the spindle. The message disappears.

Control alarms 2000 - 5999

The alarms are released by the software.

Fagor 8055 TC/MC
Heidenhain TNC 426
CAMConcept
EASY CYCLE
Sinumerik OPERATE
Fanuc 31i
Heidenhain TNC 640

2200 Syntax error in line %s, column %s

Cause: Syntax error in the program code.

2001 Circle end point invalid

Cause: The start-middle point and middle-end point distances differ by more than 3 µm.

Remedy: Correct circular arc point.

2300 tracyl without corresponding round-axis invalid

Cause: Maybe the machine has no rotary axis.

3000 Traverse feed axis manually to position %s

Remedy: Move the axis manually to the required position.

3001 Tool T.. change!

Cause: A new tool was programmed in the NC program.

Remedy: Clamp the required tool in the machine.

4001 slot width too small

Cause: The tool radius is too large for the slot to be milled.

4002 slot length to small

Cause: The slot length is too small for the slot to be milled.

4003 length equal zero

Cause: Pocket length, pocket width, stud length, stud width are zero.

4004 slot width too big

Cause: The programmed slot width is larger than the slot length.

4005 depth equal zero

Cause: No machining takes place since no effective cutting depth has been defined.

4006 corner radius too big

Cause: The corner radius is too large for the size of the pocket.

4007 diameter too big

Cause: The remaining material (nominal diameter - diameter of the prebore) /2 is larger than the tool diameter.

4008 diameter too small

Cause: The tool diameter is too large for the intended bore.

Remedy: Enlarge the nominal diameter and use a smaller milling cutter.

4009 length too small

Cause: Width and length must be larger than the double tool radius.

4010 diameter less equal zero

Cause: The pocket diameter, the stud diameter, etc. must not be zero.

4011 blank diameter too big

Cause: The diameter of the machined pocket must be larger than the diameter of the premachined pocket.

4012 blank diameter too small

Cause: The diameter of the machined stud must be smaller than the diameter of the premachined stud.

4013 start angle equal to end angle

Cause: Start angle and end angle for hole pattern are identical.

4014 tool radius 0 not permitted

Cause: Tool radius zero is not permitted.

Remedy: Select a valid tool.

4015 no outer contour defined

Cause: The contour file indicated in the cycle was not found.

4017 tool radius too big

Cause: For the programmed machining, a tool being too large was selected. Therefore, machining is not possible.

4018 allowance must not be 0

Cause: There were programmed finishing operations without finishing offset.

4019 too many iterations

Cause: The contour definitions are too complex for the roughing-out cycle.

Remedy: Simplify the contour.

4020 illegal radian correction

Cause: An error has occurred during the programming of the radius compensation.

Remedy: Check the cycle parameters.

4021 can't calculate parallel contour

Cause: The control was not able to calculate the tool radius compensation.

Remedy: Check the programmed contour for plausibility. Maybe contact EMCO.

4022 illegal contour definition

Cause: The programmed contour is not suited to the selected machining.

Remedy: Check the programmed contour.

4024 no contour definition

Cause: The contour file being defined in the cycle has not been found.

4025 internal calculation error

Cause: An unexpected error has occurred during calculation of the cycle movements.

Remedy: Please inform the EMCO after-sales service.

4026 allowance too big

Cause: A part of the finishing offset (for several finishing passes) is larger than the total finishing offset.

Remedy: Correct the finishing offsets.

4028 pitch 0 not permitted

Cause: The thread was programmed with pitch zero.

4029 undefinded working mode

Cause: Internal error (invalid machining type for the thread).

4030 function not yet supported

Cause: Roughing out with pockets is not implemented yet.

Remedy: Please inform the EMCO after-sales service.

4031 value not permitted

Cause: An invalid retracting direction was programmed during inside turning.

4032 plunging must be defined

Cause: For the programmed cycle no cutting depth has been programmed.

4033 radius/chamfer too big

Cause: The radius, respectively the chamfer, cannot be inserted in the programmed contour.

Remedy: Reduce the radius, respectively the chamfer.

4034 diameter too big

Cause: The programmed starting point and the machining diameter are contradictory.

4035 diameter too small

Cause: The programmed starting point and the machining diameter are contradictory.

4036 unknown working direction

Cause: Internal error.

Remedy: Please inform the EMCO after-sales service.

4037 unknown working type

Cause: Internal error.

Remedy: Please inform the EMCO after-sales service.

4038 unknown sub cycle

Cause: Internal error.

Remedy: Please inform the EMCO after-sales service.

4039 rounding not possible

Cause: The programmed radius contradicts the rest of the cycle parameters.

4042 illegal tool width

Cause: The tool width for the cutting-off cycle must be defined.

4043 groove width too small

Cause: Internal error.

Remedy: Please inform the EMCO after-sales service.

4044 distance not defined

Cause: The distance for the multiple grooving cycle must not be zero.

4045 illegal allowance type

Cause: Internal error.

Remedy: Please inform the EMCO after-sales service.

4046 invalid speed

Cause: The spindle speed must be nonzero.

4047 invalid end point

Cause: The programmed end point contradicts the rest of the cycle definition.

4048 tool cut width too small

Cause: The cutting edge is too small for the programmed cutting depth.

4050 invalid distance

Cause: The hole patterns do not tally with the selected distance.

4052 working pattern not possible

Cause: Error in the definition of the hole pattern. The number of bores is contradictory.

4053 invalid start point

Cause: Internal error.

Remedy: Please inform the EMCO after-sales service.

4055 illegal working direction

Cause: The machining direction is contradictory to the rest of the cycle definition.

4057 plunging angle less equal zero

Cause: The plunging angle must be between 0 and 90 degree.

4058 chamfer too large

Cause: The programmed chamfer is too large for the pocket cycle.

4062 radius/chamfer too small

Cause: The radius, respectively the chamfer, cannot be machined with the current tool radius.

4066 invalid mill step

Cause: The mill step must be greater than zero.

4069 invalid angle

Cause: An angle of zero degree is not permitted.

4072 plunging too small

Cause: For the cycle, a cutting depth has been selected that leads to extra-long machining time.

4073 invalid clearance angle

Cause: The clearance angle indicated for the tool cannot be machined.

Remedy: Correct the clearance angle for the tool.

4074 contour-file not found

Cause: The contour file indicated in the cycle has not been found.

Remedy: Please select the contour file for the cycle.

4075 not machinable with selected tool

Cause: The tool is too wide for the programmed groove.

4076 reciprocating plunge cut impossible (initial move too short)

Cause: The first movement of the contour is shorter than the double tool radius and cannot be therefore used for the swinging delivery.

Remedy: Extend the first movement of the contour.

4077 wrong tool type in grooving or cut-off cycle

Cause: The wrong tool type was used in the cutting cycle.

Remedy: Use only grooving and punch tools in the cutting cycles.

4078 radius of helix too small

Cause: The pitch of the helix is ≤ 0 .

Remedy: Program the radius > 0 .

4079 pitch of helix too small

Cause: The radius of the helix is ≤ 0 .

Remedy: Program the pitch > 0 .

4080 radius of helix or tool too large

Cause: The helical approach cannot be executed with the selected data for the helix and the current tool radius without a contour breach.

Remedy: Use a tool with a smaller radius or reduce the radius of the helix.

4200 leaving movement is missing

Cause: No movement after the tool radius compensation was deactivated in the current plane.

Remedy: Insert the departing movement in the current plane after having deactivated the tool radius compensation.

4201 TPC off missing

Cause: The tool radius compensation has not been deactivated.

Remedy: Deactivate the tool radius compensation.

4202 TPC requires at least three movements

Cause: The tool radius compensation requires at least 3 movements in the current plane in order to calculate the tool radius compensation.

4203 approaching movement not possible

Cause: It was not possible to calculate the approaching movement.

4205 leaving movement not possible

Cause: It was not possible to calculate the departing movement.

4208 TPC curve could not be calculated

Cause: It was not possible to calculate the tool radius compensation for the programmed contour.

4209 switching the plane is not allowed when TPC is switched on

Cause: The programmed plane must not be changed during the tool radius compensation.

Remedy: Remove the change of planes during the tool radius compensation.

4210 tool path compensation already activated

Cause: G41 is active and G42 was programmed or G42 is active and G41 was programmed.

Remedy: Switch tool radius compensation off with G40 before programming the radius compensation again.

4211 Bottleneck detected

Cause: In the radius correction calculation some parts of the contour were omitted, as too large a milling cutter tool was used.

Remedy: Use a smaller milling cutting tool to process the contour completely.

4212 Infeed has been programmed twice during approach

Cause: After the approach movement a second infeed has been programmed, without previously moving to the work plane.

Remedy: First program a movement to the work plane before programming a second infeed.

5000 drill manually now**5001 contour has been adjusted to the programmed clearance angle**

Cause: The programmed contour was adapted to the programmed clearance angle. Maybe there will remain rest material that cannot be machined with this tool.

5500 3D simulation: Internal error

Cause: Internal error inside the 3D simulation.

Remedy: Restart the software or, if necessary, report the error to EMCO customer service.

5502 3D simulation: Tool place invalid

Cause: Tool place unavailable on the machine used.

Remedy: Correct tool call-up.

5503 3D simulation: Chuck invalid owing to the unmachined part definition

Cause: The distance from the front of the unmachined part is > the unmachined part length.

Remedy: Change the distance.

5505 3D simulation: Unmachined part definition invalid

Cause: Implausibility in the unmachined part geometry (e.g. expansion in one axis ≤ 0 , inside diameter > outside diameter, unmachined part contour not closed, etc.).

Remedy: Correct unmachined part geometry.

5506 3D simulation: STL chuck file has auto-overcuts

Cause: Error in the chuck description.

Remedy: Correct file.

5507 3D simulation: Pole transit on TRANS-MIT!

Cause: Travel comes too close to the X0 Y0 coordinates.

Remedy: Change travel.

X: EMConfig

Note:

The settings which are available in EMConfig are depending on the machine and the control that is used.



General

EMConfig is a configuration software for WinNC. EMConfig helps you to alter the settings of WinNC.

The most important settings are:

- Control language
- System of measurement mm - inch
- Activate accessories
- Selection of interface for control keyboard

Using EMConfig you can also activate diagnostic functions in case of troubles - that way you get help immediately.



Safety-related parameters are protected by a password. They can only be activated by set-up technicians or by technical support representatives.



Icon for EMConfig

How to start EMConfig

Open EMConfig.

In case several control types are installed, a selection box will appear on the screen.

Select the required control type and click OK.

The following settings are only valid for the selected control type.

The window for EMConfig appears on the screen.

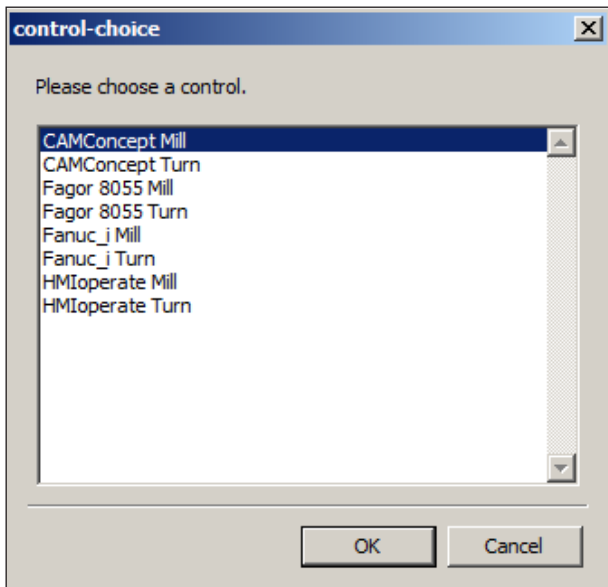

Selection box for control type

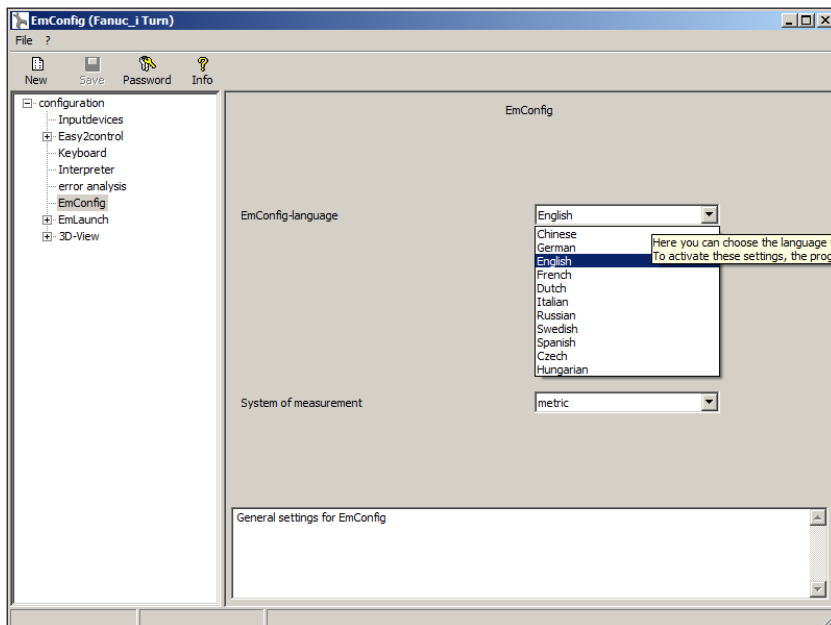

Change the language of EMConfig

Here you can change the language of EMConfig. In order to activate the settings, restart the program.

Note:

Select the desired menu item. The appropriate function is explained in the text box.



How to activate accessories

When you install accessories on your machine, you need to activate them here.

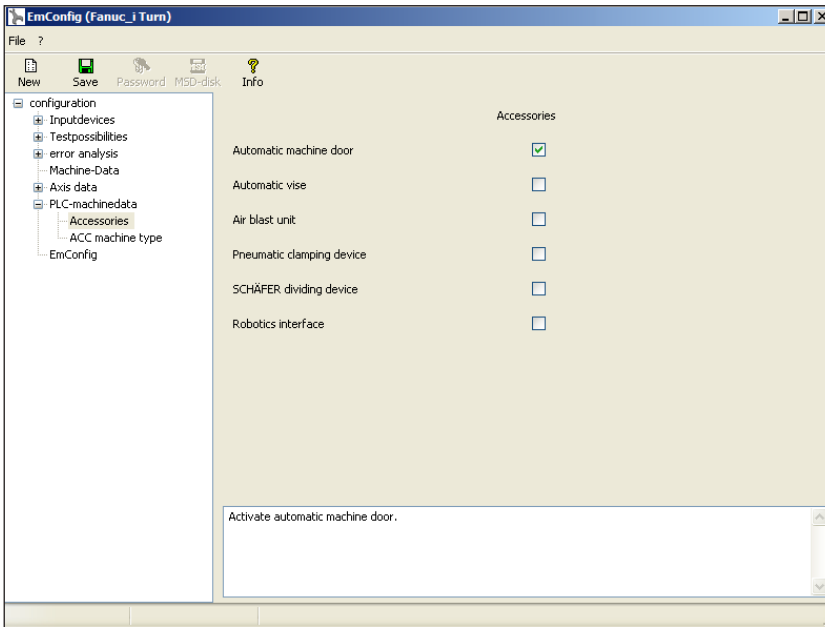

Activate accessories

High Speed Cutting

On activating this checkbox, High Speed Cutting is turned on.

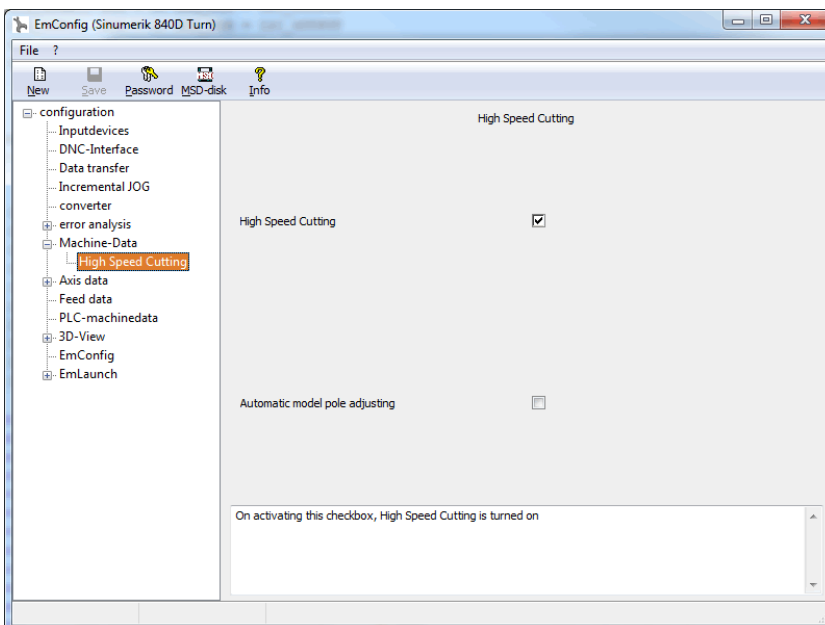

Activate High Speed Cutting

By using high speed cutting, the setting of the axis controller is adjusted. This gain is only effective until the programmed feed rate of 2500 mm/min and allows contour faithful retraction of the tool path and generating of sharp edges. If the feed is set up to higher than 2500 mm/min, it is automatically reset to the normal operating mode and sanded and rounded edges are created.

Note:

If Easy2control is used without the hardware-dongle, the controls are deactivated and an appropriate alarm is output by the controller. However, the virtual keyboard is displayed completely.



Easy2control on screen operation

Installation and activation using the example of WinNC for Sinumerik Operate.

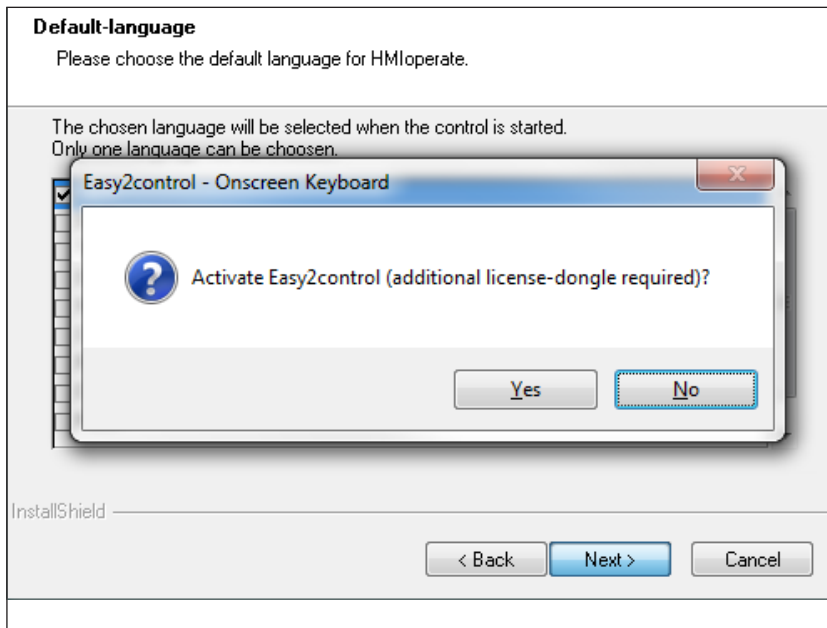

When installing the software WinNC for Sinumerik Operate you will be prompted to activate Easy2control. In order to use the Software without restriction, the supplied dongle must be connected to a free USB port.

Activating Easy2control

Settings

This mask allows you to enable or disable Easy2control and make settings.

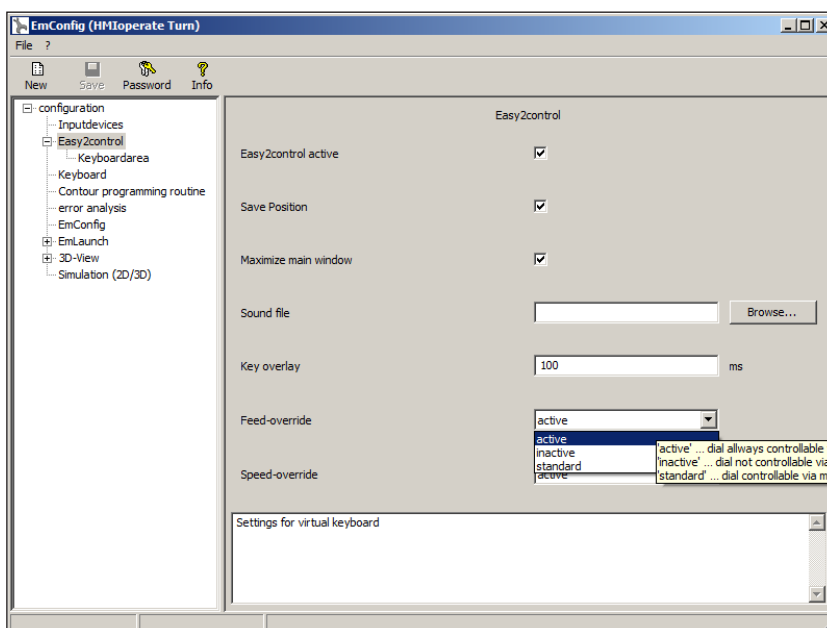

Dial feed-override and dial speed-override:

- **Active:** dial always controllable via mouse/touchscreen (even with available hardware-version).
- **Inactive:** dial not controllable via mouse/touchscreen.
- **Standard:** dial controllable via mouse/touchscreen when no hardware-version is available.

Easy2control settings

Machine room camera

The accessory machine room camera is available for all controls which support Easy2control.

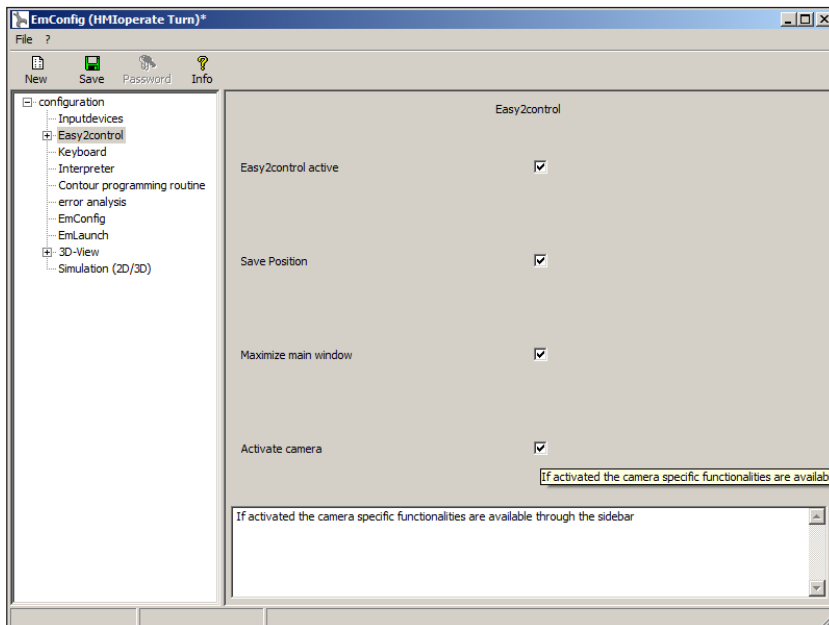

Activate camera

Please refer to chapter Y “external input devices” for more information about the installation guide for the camera.

**Attention:**

The camera may not be operated without the supplied waterproof case.

If the camera is operated without the waterproof case it may be damaged by coolant and chips.

**Danger:**

Make sure the machine room camera is placed properly in the work area that collisions with the tool turret and the axes are avoided.

How to save changes

After the settings, the changes must be saved.

Select "Save" or click on the icon.

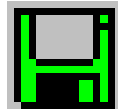

Note:

Input fields highlighted in red indicate inadmissible values. Inadmissible values are not saved in EMConfig.



After saving the changes, create a machine data floppy disk (MSD) or a machine data USB flash drive.

How to create machine data floppy disk or machine data USB flash drive

After having changed the machine data, the machine data floppy disk or the machine data USB flash drive must be in the appropriate drive. Otherwise your changes cannot be saved and get lost.

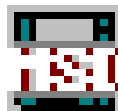

Z: Software Installation Windows

System prerequisites

Machine with integrated control PC

- All Concept machines
- Machines that were converted to ACC
- MOC with Windows 7 or higher (32 / 64 Bit)

Machines with included control PC and programming stations

- Windows 7 or higher (32 / 64 Bit)
- free hard drive space 400 MB
- Programming station: 1*USB, machine version: 2*USB
- TCP/IP-capable network card for machine version)

Recommended system prerequisites

- PC Dual Core
- Working memory 4 GB RAM
- free hard drive space 2 GB

Software installation

- Start Windows
- Start the installation application on the USB stick or your download file.
- Follow the instructions from the installation guide.

For more informations regarding software installation and / or software update please refer to the documentation "short description for WinNC update installation".

Note:

PC TURN and PC MILL have to be equipped with the conversion kit for ACC in order to operate EMCO WinNC.



Variants of WinNC

You can install EMCO WinNC for the following CNC control types:

- WinNC for SINUMERIK Operate T and M
- WinNC for FANUC 31i T and M
- HEIDENHAIN TNC 426
- Emco WinNC for HEIDENHAIN TNC 640
- FAGOR 8055 TC and MC
- CAMConcept T and M

In case there are several control types installed, a menu appears when starting EM Launch from which you can select the desired type.

The following versions can be installed from the WinNC variants:

- Demo licence:
The demo licence is valid for 30 days after the first use. 5 days before the demo licence expires, you can enter another valid licence key (see licence manager)
- Programming station:
Programming and operation of the appropriate CNC control type is simulated by WinNC on your PC.
- Single user licence:
Authorizes to external programming of CNC-controlled machine tools on one PC workstation.
- Multi-user licence:
Authorizes to external programming of CNC-controlled machine tools. The multi-user licence can be installed on an unlimited number of PC workstations or in a network within the institute registered by the licensor.
- Educational licence version:
Is a time-limited multi-licence especially for schools and educational institutes.
- Machine licence:
This licence allows to directly operate a PC-controlled machine (PC TURN, Concept TURN, PC MILL, Concept MILL) of WinNC as if it was operated by an ordinary CNC control.

**Danger:**

Removal and installation of the network card must only be carried by skilled personnel. The computer must be disconnected from the power supply (pull the power plug).

**Note:**

During a machine installation one network-card is reserved exclusively for the control of the machine.

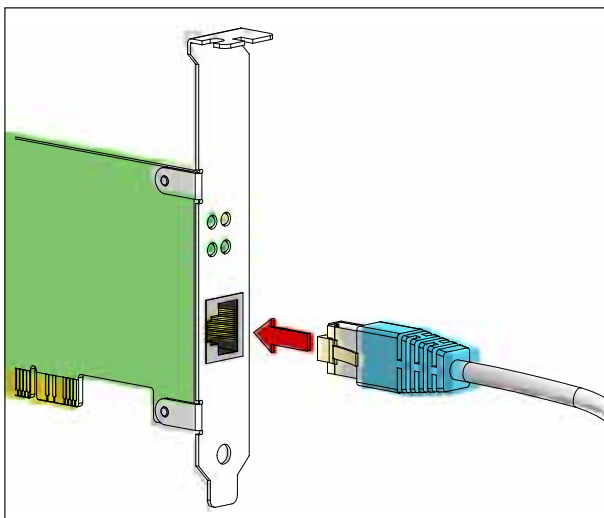

Connection of the machine to the PC

Network card (ACC)

for:

Concept Turn 55
 Concept Mill 55
 Concept Turn 105
 Concept Mill 105
 Concept Turn 60

Only for machines with ACC kit:

PC Turn 50
 PC Mill 50
 PC Turn 100
 PC Mill 120

Network card type: TCP/IP compatible network card

Setting the network card for the local connection to the machine:

IP address: 192.168.10.10
Subnetmask 255.255.255.0



In case of problems observe the instructions of your operating system (Windows help).

Instructions:

If the network connection to the machine could not be established at the start, the above adjustments are to be made.

Starting WinNC

If you choose AUTO START YES during the installation of your machine version, WinNC starts automatically after switching on the PC.

Otherwise proceed as follows:

- 1 Switch the machine on.
- 2 Wait for 20 seconds to ensure that the machine operating system is running before the network connection to the PC is established. Otherwise it is possible that no connection can be established.
- 3 Switch the PC on and start Windows.
- 4 Click on the start symbol at the bottom.
- 5 Select program, EMCO and click on WinNC.
- 6 The start image will be shown on the screen. The licence holder is registered in the start screen.
- 7 If you have only installed one CNC control type, it starts immediately.
- 8 If you have installed several CNC control types, the selection menu appears.
- 9 Select the desired CNC control type (use cursor buttons or mouse) and press ENTER to start it.
- 10 If you use the control keyboard, you can select the desired CNC control type with the cursor buttons or mouse and start with the "NC-Start" button.

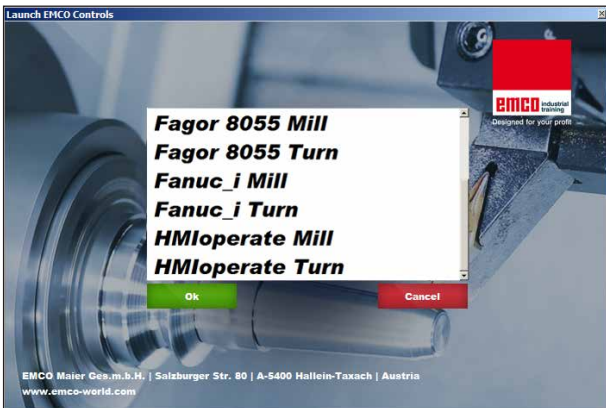

Selection menu EMLaunch

Note:
EMLaunch displays all WinNC und CAMConcept controls that are installed in the same directory.



Terminating WinNC

- 1 Switch off auxiliary drive with AUX OFF.
Only for machine places, not for programming stations.
- 2 By simultaneously pressing these buttons WinNC for Sinumerik Operate will be terminated specifically.
This corresponds to Alt+F4 on the PC keyboard.

Checks by EmLaunch

In the ACC / ACpn-machine version EmLaunch is checking if a machine is available:

During the network configuration, the IP address is not configured correctly and DHCP for automatic configuration of the IP address is disabled. Connection to the machine is not possible.



DHCP disabled

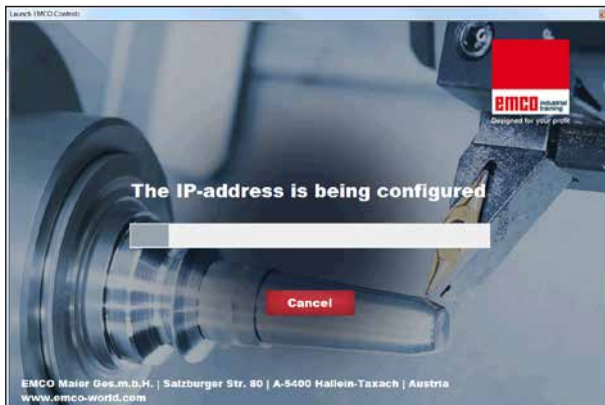

IP-address configuration



Setup the connection to the machine

It is attempt to configure the IP address automatically via DHCP.

The IP configuration is correct and the connection to the machine is checked. Once the machine is available, the selection of the available controls is displayed.

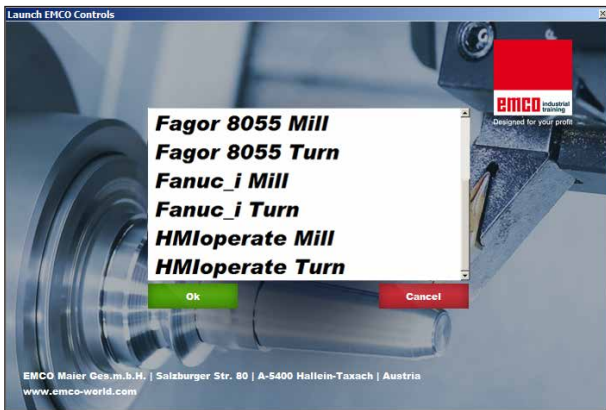

Connection to the machine is OK

The connection to the machine is completed and the corresponding control can be started.

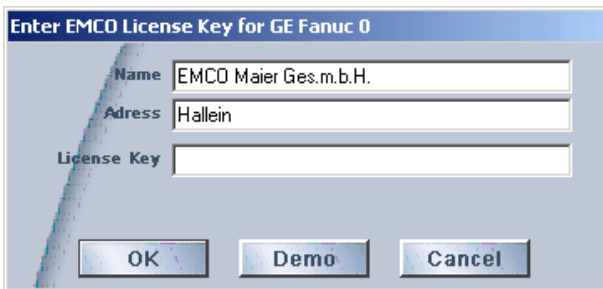

Input window licence key enquiry

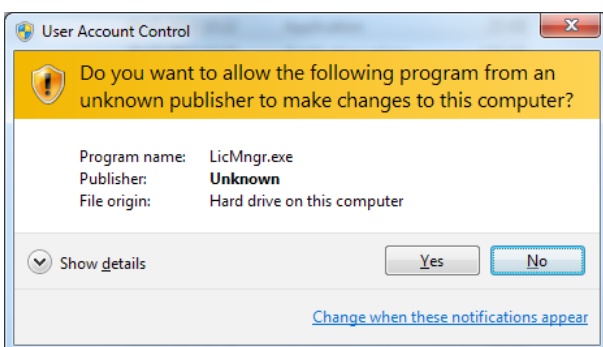

Run EMCO licence manager as an administrator

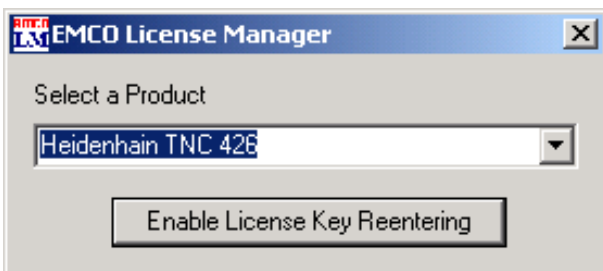

EMCO Licence Manager

Licence input

After the installation of an EMCO software product, an input window appears during initial operation and asks for name, address and licence key. This input window appears for every software product that is installed. In case a demo licence is desired (see page Z1), please select "DEMO". Then the input window reappears only 5 days before the expiry date of the demo licence. A subsequent input of a licence key is also possible via the licence manager (see licence manager below).

Licence manager

The query in the UAC dialog box must be confirmed with Yes in order to start the Licence Manager.

For the release of additional function groups of existing EMCO software products it is necessary to enter a new licence key (exception: demo licence).

The **EMCO Licence Manager** (see picture on the bottom on the left) enables the input of further new licence keys. For this purpose select the new product in the selection window and confirm the input.

The next time you start your control software an input window appears and asks you to enter name, address and licence key (see picture on the top left).

Please note that the licence key is asked for each software product individually. The picture on the left shows e.g. the input prompt for the licence key for the software product "Heidenhain TNC 426".

Input licence key:

Start the WinNC with the option "Run as Administrator" right after installing the program or launching the licence manager.